

## IMPORTANT NOTICE

**IMPORTANT: You must read the following disclaimer before continuing.** The following disclaimer applies to the attached offering memorandum (the “Offering Document”) accessed from this page or otherwise received as a result of such access and you are therefore advised to read this disclaimer page carefully before reading, accessing or making any other use of the Offering Document. In accessing the Offering Document, you agree to be bound by the following terms and conditions, including any modifications to them from time to time, each time you receive any information from us as a result of such access.

NOTHING IN THIS ELECTRONIC TRANSMISSION CONSTITUTES AN OFFER OF SECURITIES FOR SALE IN ANY JURISDICTION WHERE IT IS UNLAWFUL TO DO SO. THE SECURITIES HAVE NOT BEEN, AND WILL NOT BE, REGISTERED UNDER THE U.S. SECURITIES ACT OF 1933, AS AMENDED (THE “SECURITIES ACT”), OR THE SECURITIES LAWS OF ANY STATE OF THE UNITED STATES OF AMERICA OR OTHER JURISDICTION AND THE SECURITIES MAY NOT BE OFFERED OR SOLD, EXCEPT PURSUANT TO AN EXEMPTION FROM, OR IN A TRANSACTION NOT SUBJECT TO, THE REGISTRATION REQUIREMENTS OF THE SECURITIES ACT AND APPLICABLE STATE OR LOCAL SECURITIES LAWS.

THE ATTACHED OFFERING DOCUMENT MAY NOT BE FORWARDED OR DISTRIBUTED TO ANY OTHER PERSON AND MAY NOT BE REPRODUCED IN ANY MANNER WHATSOEVER. ANY FORWARDING, DISTRIBUTION OR REPRODUCTION OF THE OFFERING DOCUMENT IN WHOLE OR IN PART IS UNAUTHORIZED. FAILURE TO COMPLY WITH THIS DIRECTIVE MAY RESULT IN A VIOLATION OF THE SECURITIES ACT OR THE APPLICABLE LAWS OF OTHER JURISDICTIONS.

**CONFIRMATION OF YOUR REPRESENTATION:** In order to be eligible to view the Offering Document or make an investment decision with respect to the securities, investors must be either (i) a “qualified institutional buyer,” within the meaning of and in reliance on Rule 144A under the Securities Act or (ii) a non “U.S. person” (as defined in Rule 902 under the Securities Act) in an offshore transaction in accordance with Regulation S under the Securities Act (either (i) or (ii) being an “Eligible Investor”). By opening the e-mail or accessing the Offering Document, you shall be deemed to have represented to Citigroup Global Markets Inc., HSBC Securities (USA) Inc. and Itau BBA USA Securities, Inc. (the “Joint Lead Managers”) that (1) you and any customer you represent is an Eligible Investor; and (2) you consent to delivery of the Offering Document by electronic transmission. By receiving this Offering Document, you represent that you are not residing in a jurisdiction considered as non-cooperating (jurisdicción no cooperante) or paying for notes with funds transferred from accounts maintained in jurisdictions considered as non-cooperating, in each case as determined under applicable Argentine law or regulation.

You shall also be deemed to have represented that you: (i) are outside the United Kingdom; (ii) have professional experience in matters relating to investments falling within Article 19(5) of the Financial Services and Markets Act 2000 (Financial Promotion) Order 2005 (as amended, the “Financial Promotion Order”); (iii) are a person falling within Articles 49(2)(a) to (d) (“high net worth companies, unincorporated associations, etc.”) of the Financial Promotion Order; or (iv) are a person to whom an invitation or inducement to engage in investment activity (within the meaning of section 21 of the Financial Services and Markets Act 2000, as amended) in connection with the issue or sale of any securities may otherwise lawfully be communicated or caused to be communicated (all such persons together being referred to as “relevant persons”). The Offering Document is directed only at relevant persons and must not be acted on or relied on by persons who are not relevant persons. Any investment or investment activity to which the Offering Document relates is available only to relevant persons and will be engaged in only with relevant persons.

The securities are not intended to be offered, sold or otherwise made available to and should not be offered, sold or otherwise made available to any retail investor in the European Economic Area (“EEA”). For these purposes, the expression retail investor means a person who is one (or more) of the following: (i) a retail client as defined in point (11) of Article 4(1) of Directive 2014/65/EU (as amended, “MiFID II”), or (ii) a customer within the meaning of Directive (EU) 2016/97 (as amended, the “IDD”), where that customer would not qualify as a professional client as defined in point (10) of Article 4(1) of MiFID II; or (iii) not a qualified investor as defined in Directive 2003/71/EC (as amended, the “Prospectus Directive”). Consequently, no key information document required by Regulation (EU) No 1286/2014 (as amended, the “PRIIPs Regulation”) for offering or selling the securities or otherwise making them available to retail investors in the EEA has been prepared and therefore offering or selling the securities or otherwise making them available to any retail investor in the EEA may be unlawful under the PRIIPs Regulation.

You are reminded that documents transmitted via this medium may be altered or changed during the process of transmission and, consequently, none of the Joint Lead Managers nor any person who controls any Joint Lead Managers or any of their directors, officers, employees or agents, or affiliate of any such person accepts any liability or responsibility whatsoever in respect of any changes made without knowledge of such entity. You are reminded that the Offering Document has been delivered to you on the basis that you are a person into whose possession the Offering Document may be lawfully delivered in accordance with the laws of the jurisdiction in which you are located and you may not, nor are you authorized to, deliver the Offering Document to any other person. You will not transmit the Offering Document (or any copy or part thereof) or disclose, whether orally or in writing, any of the contents of the Offering Document to any other person except with the consent of the Joint Lead Managers.

US\$400,000,000



**YPF ENERGÍA ELÉCTRICA S.A.  
10.000% Senior Notes due 2026**

We are offering US\$400,000,000 aggregate principal amount of our 10.000% senior notes due 2026 (the “Notes”). Interest on the Notes will accrue at a rate of 10.000% per year and will be payable semi-annually in arrears on July 25 and January 25 of each year, commencing on January 25, 2020. The Notes will mature on July 25, 2026.

The Notes will not be redeemable prior to maturity except as provided herein. We may redeem the Notes, at our option, in whole or in part, at any time prior to July 25, 2023 at a redemption price equal to the principal amount of the Notes and a make-whole amount, plus accrued and unpaid interest thereon, if any, to the redemption date. We may redeem the Notes, at our option, in whole or in part, at any time on or after July 25, 2023, at the redemption price set forth herein, plus accrued and unpaid interest thereon, if any, to the redemption date. At any time prior to July 25, 2023, we may redeem up to 35% of the original principal amount of the Notes with the proceeds of certain equity offerings at a redemption price of 110% of the principal amount of the Notes, plus accrued and unpaid interest, if any, to the date of redemption. In addition, we may redeem all the Notes, in whole but not in part, at par plus accrued and unpaid interest, if any, to the redemption date and any additional amounts in the event of certain changes in tax law.

The Notes will constitute our direct, unconditional, senior, unsecured obligations and will rank at all times equal in right of payment with all our other existing and future unsecured and unsubordinated indebtedness (other than obligations preferred by operation of law). The Notes will be effectively subordinated to any secured indebtedness to the extent of the value of the assets securing such indebtedness and to any indebtedness and other liabilities of our subsidiaries.

We have applied to have the Notes listed on the Luxembourg Stock Exchange and to admit the Notes for trading on the Euro MTF Market (the “Euro MTF”) of the Luxembourg Stock Exchange. We also applied to have the Notes admitted for trading on the Mercado Abierto Electrónico S.A. (the Argentine over-the-counter market, or the “MAE”). We cannot assure you that these applications will be accepted.

**Investing in the Notes involves a high degree of risk. For a discussion of certain risks in connection with your investment in the Notes, see “Risk Factors” beginning on page 17.**

---

**Issue Price: 98.772% plus accrued interest, if any, from July 25, 2019**

---

**The Notes will not be registered under the U.S. Securities Act of 1933, as amended (the “Securities Act”). The Notes may not be offered or sold within the United States or to U.S. persons, except to qualified institutional buyers in reliance on the exemption from registration provided by Rule 144A under the Securities Act (“Rule 144A”) and to non-U.S. persons in offshore transactions in reliance on Regulation S under the Securities Act (“Regulation S”). For a description of certain restrictions on the transfer of the Notes, see “Transfer Restrictions.”**

The Notes will be issued under our US\$1,500,000,000 million global notes program (the “Program”). The Notes will constitute non-convertible negotiable obligations under the Argentine Negotiable Obligations Law No. 23,576, as amended (the “Negotiable Obligations Law”), will be entitled to the benefits set forth therein and subject to the procedural requirements established therein, and will be issued and placed in accordance with such law, Law No. 26,831 as amended (the “Argentine Capital Markets Law”), and the General Resolution No. 622/2013, issued by the Comisión Nacional de Valores (the Argentine Securities Commission (the “CNV”) as amended (the “CNV Rules”), and any other Argentine applicable laws and regulations. The Program was approved by our shareholders on March 16, 2018; and the issuance of the Notes was approved by our board of directors on July 17, 2019 by delegation of authority granted by our shareholders on March 16, 2018. The Program has been authorized by the CNV pursuant to Resolution No. RESFC-2019-20192-APN-DIR#CNV, dated April 17, 2019. The CNV authorizations mean only that the information requirements of the CNV have been satisfied. The CNV has not rendered any opinion in respect of the accuracy of the information contained in this offering memorandum. In making an investment decision, all investors, including any Argentine investors who may acquire Notes from time to time, must rely on their own review and examination of the issuer.

The Notes are not intended to be offered, sold or otherwise made available to, and should not be offered, sold or otherwise made available to, any retail investor in the European Economic Area. For the purposes of this provision the expression “retail investor” means a person who is one (or more) of the following: (i) a retail client as defined in point (11) of Article 4(1) of Directive 2014/65/EU (as amended, “MiFID II”), or (ii) a customer within the meaning of Directive (EU) 2016/97 (as amended, the “IDD”), where that customer would not qualify as a professional client as defined in point (10) of Article 4(1) of MiFID II; or (iii) not a qualified investor as defined in Directive 2003/71/EC (as amended, the “Prospectus Directive”). Consequently, no key information document required by Regulation (EU) No 1286/2014 (as amended, the “PRIIPs Regulation”) for offering or selling the Notes or otherwise making them available to retail investors in the European Economic Area has been prepared and therefore offering or selling the Notes or otherwise making them available to any retail investor in the European Economic Area may be unlawful under the PRIIPs Regulation. This offering memorandum constitutes a prospectus for purposes of Part IV of the Luxembourg law on prospectus securities dated July 10, 2005, as amended. This offering memorandum may only be used for the purpose for which it has been published.

The Notes are expected to be delivered in book-entry form through The Depository Trust Company (“DTC”) and its direct and indirect participants, including Euroclear Bank S.A./N.V. (“Euroclear”) and Clearstream Banking, *Société Anonyme* (“Clearstream”), on or about July 25, 2019.

---

*Joint Lead Managers*

**Citigroup**

**HSBC**

**Itaú BBA**

*Local Placement Agent*

**Itaú BBA**

The date of this offering memorandum is July 18, 2019.

## TABLE OF CONTENTS

<u>Page</u>	<u>Page</u>
Available Information.....iii	Business ..... 133
Forward-Looking Statements .....iv	Management ..... 165
Enforcement of Judgments Against Foreign Persons .....v	Principal Shareholders ..... 174
Presentation of Financial and Other Information.....vii	Certain Relationships and Related Party Transactions ..... 177
Technical and Regulatory Terms .....x	Description of the Notes ..... 181
Summary..... 1	Form of Notes, Clearing and Settlement ..... 221
Risk Factors ..... 17	Transfer Restrictions..... 225
Exchange Rates and Exchange Controls ..... 46	Taxation..... 228
Use of Proceeds ..... 49	Plan of Distribution ..... 238
Capitalization..... 50	Legal Matters ..... 247
Selected Financial Data ..... 51	Independent Auditors ..... 248
Management’s Discussion and Analysis of Financial Condition and Results of Operations.... 54	Listing and General Information..... 249
The Argentine Electric Power Sector ..... 83	Index to Financial Statements..... F-1

---

**You should rely only on the information contained in this offering memorandum. No person has been authorized to provide you with different information and neither we nor the initial purchasers take any responsibility for any other information that anyone else may provide you. If anyone provides you with different or inconsistent information, you should not rely on it. Neither we nor any of the initial purchasers is making an offer to sell the Notes in any jurisdiction where the offer or sale is not permitted. You should not assume that the information contained in this offering memorandum is accurate as of any date other than the date on the front cover page of this offering memorandum. Our business, financial condition, results of operations and prospects may have changed since that date. Neither the delivery of this offering memorandum nor any sale of Notes made hereunder will, under any circumstances, imply that there has been no change in our affairs or that the information set forth in this offering memorandum is correct as of any date subsequent to the date of this offering memorandum.**

This offering memorandum is intended solely for distribution and use outside of Argentina, and is being distributed or used by us and the initial purchasers solely outside of Argentina. This offering memorandum does not constitute an offer to sell, or a solicitation of an offer to buy, any Notes offered by this offering memorandum by any person in any jurisdiction in which it is unlawful for that person to make an offer or solicitation.

We have prepared this offering memorandum solely for use in connection with the offer of the Notes and take responsibility for its contents. We have furnished the information (including information from other sources we believe to be reliable) contained in this offering memorandum. Nothing contained in this offering memorandum is or shall be relied upon as a promise or representation, whether as to the past or the future, and the opinions and intentions expressed in this offering memorandum with regard to us are honestly held, and have been reached after considering all relevant circumstances and are based on reasonable assumptions, and all reasonable inquiries have been made by us to ascertain such facts and to verify the accuracy of all such information and statements in all material respects. We accept responsibility accordingly.

The initial purchasers are not making any representation or warranty as to the accuracy or completeness of the information contained in this offering memorandum.

You acknowledge that (i) you have been afforded an opportunity to request from us, and to review, all additional information considered by you to be necessary to verify the accuracy of, or to supplement, the information contained in this offering memorandum, (ii) you have not relied on us or the initial purchasers, or any person affiliated with us or them, in connection with your investigation of the accuracy of the information or your investment decision, and (iii) no person has been authorized to give any information or to make any representation concerning us or the Notes other than as contained in this offering memorandum.

Neither the U.S. Securities and Exchange Commission (the “SEC”), nor any state securities commission nor any other regulatory authority in the United States has approved or disapproved the Notes, nor has any of the foregoing authorities passed upon or endorsed the merits of the offering or the accuracy or adequacy of this offering memorandum. Any representation to the contrary is a criminal offense in the United States.

The Notes will not be registered under the Securities Act or any state securities laws in the United States. Therefore, the Notes may not be offered or sold within the United States or to, or for the account or benefit of, any U.S. person unless the offer or sale would qualify for an exemption from registration under the Securities Act and applicable U.S. state securities laws. Accordingly, the Notes are being offered and sold in the United States only to qualified institutional buyers in accordance with Rule 144A under the Securities Act and outside the United States to non-U.S. persons in accordance with Regulation S under the Securities Act. The Notes may not be transferred or resold except as permitted under the Securities Act and applicable U.S. state securities laws. See “Plan of Distribution” and “Transfer Restrictions” for a description of the restrictions on transfer of the Notes.

The Issuer, its beneficial owners, and the individuals and legal entities which own at least 20% of the capital stock or voting rights or which through other means exercise the final control, direct or indirect over the Issuer, do not have any sentence and/or conviction against them for money laundering crimes and/or terrorism financing and do not appear in lists of terrorists and terrorist organizations issued by the United Nations Security Council.

You should be aware that you may be required to bear the financial risks of this investment for an indefinite period of time. See “Risk Factors” for a description of specified risk factors relating to an investment in the Notes.

You must (i) comply with all applicable laws and regulations in force in any jurisdiction in connection with the possession or distribution of this offering memorandum and the purchase, offer or sale of the Notes and (ii) obtain any consent, approval or permission required to be obtained by you for the purchase, offer or sale by you of the Notes under the laws and regulations applicable to you in force in any jurisdiction to which you are subject or in which you make such purchases, offers or sales. Neither we or the initial purchasers nor any of our or their affiliates shall have any responsibility therefor.

In making your decision whether to invest in the Notes, you must rely on your own examination of us and the terms of the offering, including the merits and risks involved. You should not construe the contents of this offering memorandum as legal, business, financial or tax advice. You should consult with your own advisors as to legal, tax, business, financial and related aspects of a purchase of the Notes.

#### **NOTICE TO INVESTORS IN THE EUROPEAN ECONOMIC AREA**

In connection with the offering of the Notes, the initial purchasers (or persons acting on their behalf) may overallocate Notes (provided that, in the case of any Notes to be admitted to trading on the Euro MTF, the aggregate principal amount of Notes allotted does not exceed 105% of the aggregate principal amount of the Notes subject to the offering) or effect transactions with a view to supporting the market price of the Notes during the stabilization period at a level higher than that which might otherwise prevail. However, stabilization may not necessarily occur. Any stabilization action may begin on or after the date of adequate public disclosure of the terms of the offer of the Notes and, if begun, may cease at any time, but it must end no later than 30 calendar days after the date on which the issuer received the proceeds of the issue, or no later than 60 calendar days after the date of allotment of the Notes, whichever is earlier. Any stabilization action or overallocation must be conducted by the relevant initial purchaser(s) (or persons acting on their behalf) in accordance with all applicable laws and rules and will be undertaken at the offices of the initial purchasers (or persons acting on their behalf) and on the Euro MTF.

This offering memorandum has been prepared on the basis that any offer of Notes in any member state of the European Economic Area will be made pursuant to an exemption under the Prospectus Directive from the requirement to publish a prospectus for offers of Notes. Accordingly any person making or intending to make an offer in that Member State of Notes which are the subject of the offering contemplated in this offering memorandum may only do so in circumstances in which no obligation arises for us or any of the initial purchasers to publish a prospectus pursuant to Article 3 of the Prospectus Directive in relation to such offer. Neither we nor the initial purchasers have authorized, nor do we nor the initial purchasers authorize, the making of any offer of Notes in circumstances in which an obligation arises for us or the initial purchasers to publish a prospectus for such offer. The expression “Prospectus Directive” means Directive 2003/71/EC (as amended), and includes any relevant implementing measure in the Member State concerned.

The Notes are not intended to be offered, sold or otherwise made available to, and should not be offered, sold or otherwise made available to, any retail investor in the European Economic Area. For the purposes of this provision the expression “retail investor” means a person who is one (or more) of the following: (i) a retail client as defined in point (11) of Article 4(1) of MiFID II, or (ii) a customer within the meaning of the IDD, where that customer would not qualify as a professional client as defined in point (10) of Article 4(1) of MiFID II; or (iii) not a qualified investor as defined in the Prospectus Directive. Consequently, no key information document required by Regulation (EU) No. 1286/2014 (as amended, the “PRIIPs Regulation”) for offering or selling the Notes or otherwise making them available to retail investors in the European Economic Area has been prepared and therefore offering or selling the Notes or otherwise making them available to any retail investor in the European Economic Area may be unlawful under the PRIIPs Regulation.

---

#### AVAILABLE INFORMATION

To permit compliance with Rule 144A in connection with resale of Notes, we have agreed that, while any Notes remain outstanding and are “restricted securities” as defined in Rule 144(a)(3) under the Securities Act, we will furnish, upon the request of a holder of a Note or a prospective purchaser designated by such holder, the information required to be delivered by Rule 144A(d)(A) under the Securities Act unless, at the time of such request, we are either a reporting company under Section 13 or Section 15(d) of the U.S. Securities Exchange Act of 1934, as amended (the “Exchange Act”), or are furnishing to the SEC information required by Rule 12g3-2(b) under the Exchange Act. Any such request should be directed to us at our principal office at: YPF Energía Eléctrica S.A., Avenida Cordoba 111, C1054AAA, City of Buenos Aires, Argentina, Attention: Mr. Gabriel Abalos.

We are also required periodically to furnish certain information in Spanish with the CNV and the MAE, including quarterly and annual reports and notices of material events (*hechos relevantes*). The documents filed with the CNV and the MAE, and any other information contained or accessible therein, are not a part of this offering memorandum and are not incorporated by reference herein.

## FORWARD-LOOKING STATEMENTS

This offering memorandum contains certain information that is forward-looking, including but not limited to our expectations for conditions in Argentina and in our industry as well as our future performance, financial condition and results of operations, capital expenditures, liquidity and capital structure. Forward-looking statements may be identified by words such as “may,” “would,” “will,” “believe,” “expect,” “anticipate,” “project,” “plan,” “intend,” “should,” “seek,” “estimate,” “future” “potential” or similar expressions. These statements include statements regarding our current expectations and assumptions and are not guarantees of future performance. While we consider these expectations and assumptions to be reasonable, forward-looking statements are subject to various risks and uncertainties, most of which are difficult to predict and many of which are beyond our control. When considering forward-looking statements, you should keep in mind the factors described in “Risk Factors” and other cautionary statements in this offering memorandum. These “Risk Factors” and other statements describe circumstances that could cause actual results to differ materially from those contained in any forward-looking statement. Accordingly, investors should not place undue reliance on forward-looking statements as a prediction of actual results.

The forward-looking statements appear throughout this offering memorandum and speak only as of the date of this offering memorandum, and we do not undertake any obligation to update any forward-looking statement or other information to reflect events or circumstances occurring after the date of this offering memorandum.

## ENFORCEMENT OF JUDGMENTS AGAINST FOREIGN PERSONS

We are organized under the laws of Argentina. Substantially all of our directors and all of our officers, as well as the experts named herein, reside in Argentina. In addition, all or a substantial portion of our assets and the assets of our directors and officers are located outside of the United States. As a result, it may be difficult or impossible for investors to effect service of process within the United States upon such persons or to enforce judgments against us or them rendered in the United States or other non-Argentine courts.

In addition, an Argentine court will not order the attachment prior to execution and attachment in aid of execution on any property located in Argentina and determined by such courts to be essential for the provision of public services. The assets related to our power generation business are considered part of an activity of general interest (*actividad de interés general*) and therefore attachment thereon is not restricted as a matter of law.

We have been advised by our Argentine counsel, Estudio O'Farrell, that there is doubt as to whether the courts of Argentina would enforce in all respects, to the same extent and in a timely manner as a U.S. court or non-Argentine court, an original action predicated solely upon the civil liability provisions of the U.S. federal or other non-Argentine securities law. Judgments of U.S. or other non-Argentine courts for civil liabilities based upon the U.S. federal or other non-Argentine securities laws could be enforced in Argentina, in accordance with the provisions of the Argentine Civil and Commercial Procedure Code (*Código Procesal Civil y Comercial de la Nación*): (i) the judgment, which must be final in the jurisdiction where rendered, was issued by a competent court in accordance with the Argentine principles regarding international jurisdiction and resulted from a personal action (*action in personam*), or an in rem action with respect to personal property if the property was transferred to Argentine territory during or after the prosecution of the foreign action, (ii) the defendant against whom enforcement of the judgment is sought was personally served with the summons and, in accordance with due process of law, was given an opportunity to defend against foreign action, (iii) the judgment is valid in the jurisdiction where rendered and meets authenticity requirements under Argentine law, (iv) the judgment does not violate the principles of public policy of Argentine law, and (v) (a) the judgment is not contrary to a prior or simultaneous judgment of an Argentine court, (b) in respect of any document in a language other than Spanish (including, without limitation, the foreign judgment and other documents related thereto), a duly legalized translation by a sworn public translator into the Spanish language is submitted to the relevant court, (c) the filing of claims with the Argentine judicial system is subject to the payment of a court tax to be paid by the person filing the claim, which tax rates vary from one jurisdiction to another (the current court tax in the courts sitting in the City of Buenos Aires is levied at a rate of 3% of the amount claimed in conformity with Article 2 of Argentine Law No. 23,898), and (d) pursuant to Argentine Law No. 26,589 as amended, certain mediation procedures must be exhausted prior to the initiation of lawsuits in Argentina (with the exception, among others, of bankruptcy and executory proceedings, including the enforcement of foreign judgments, in which case mediation procedures remain optional for the plaintiff). Subject to compliance with the requirements of Argentine law described above, a judgment against us or the persons described above obtained outside Argentina would be enforceable in Argentina without reconsideration of the merits.

In the event of a foreign arbitral award, recognition and enforcement of such award shall be made pursuant to Sections 102, 103 and 104 of Law No. 27,449 (the Argentine International Commercial Arbitration Law) or analogous principles. Under Sections 102, 103 and 104 of Law No. 27,449, a foreign arbitral award (notarized and with a Spanish translation if so required) submitted to Argentine courts in accordance with the provisions of the Argentine Civil and Commercial Procedure (or the applicable provincial code if enforcement is sought before provincial courts), may only be denied recognition and enforcement if in addition to paying the corresponding court's fee (as described above) (a) at the request of the party against whom it is invoked, that party furnishes to the competent court where recognition or enforcement is sought proof that: (i) a party to the arbitration agreement was under some incapacity or restriction to its capacity; or the said agreement is not valid under the law to which the parties have subjected it or, failing any indication thereon, under the law of the country where the award was made; (ii) the party against whom the award is invoked was not given proper notice of the appointment of an arbitrator or of the arbitral proceedings or was otherwise unable to present his case; (iii) the award deals with a dispute not contemplated by the terms of the submission to arbitration, or it contains decisions on matters beyond the scope of the submission to arbitration, provided that, if the decisions on matters submitted to arbitration can be separated from those not so submitted, that part of the award which contains decisions on matters submitted to arbitration may be recognized and enforced; (iv) the composition of the arbitral tribunal or the arbitral procedure was not in accordance with the agreement of the parties or, failing such agreement, was not in accordance with the law of the country where the

arbitration took place; or (v) the award has not yet become binding on the parties or has been set aside or suspended by a court of the country in which, or under the law of which, that award was made; or (b) if an Argentine court finds that: (i) the subject-matter of the dispute is not capable of settlement by arbitration under Argentine law; or (ii) the recognition or enforcement of the award would be contrary to Argentina's international public policy.

See "Risk Factors—Risks Relating to the Notes—Holders of the Notes may find it difficult to enforce civil liabilities against us, our directors, officers and controlling persons."



## PRESENTATION OF FINANCIAL AND OTHER INFORMATION

### Certain Defined Terms

In this offering memorandum, unless otherwise specified or the context otherwise requires, references to: “YPF Luz,” the “Company,” “we,” “us,” “our” and words of similar import are to YPF Energía Eléctrica S.A. and its consolidated subsidiaries; and references to the “Issuer” are to YPF Energía Eléctrica S.A. excluding its consolidated subsidiaries. For certain other defined terms used in this offering memorandum, see “Technical and Regulatory Terms” and “Description of the Notes—Certain Definitions.”

### Financial Statements

On March 16, 2018, our board of directors approved our adoption of International Financial Reporting Standards (“IFRS”) as issued by the International Accounting Standards Board (“IASB”). We used a transition date of January 1, 2017, and, therefore, our consolidated financial statements as of and for the year ended December 31, 2018 and 2017, were our first audited annual consolidated financial statements to be prepared in accordance with IFRS. For periods prior to January 1, 2017, we prepared our financial statements in accordance with professional accounting rules issued by Argentine Federation of Professional Councils in Economic Sciences (*Federación Argentina de Consejos Profesionales de Ciencias Económicas*) and approved by the Consejos Profesionales de Ciencias Económicas de la Ciudad de Buenos Aires.

This offering memorandum includes our audited consolidated financial statements as of December 31, 2018, December 31, 2017 and January 1, 2017 and for the years ended December 31, 2018 and 2017 (our “Audited Annual Financial Statements”). Our Audited Annual Financial Statements included in this offering memorandum have been prepared in accordance with IFRS as issued by IASB and have been audited by Deloitte & Co. S.A., independent auditors, as stated in their report appearing herein.

IFRS 1—First-time Adoption of International Financial Reporting Standards governs the adoption of IFRS and first-time preparation of consolidated financial statements and provides for certain exceptions and exemptions. See Note 2.5 to our Audited Annual Financial Statements for a description of the effects of adopting IFRS.

This offering memorandum also includes our unaudited condensed interim consolidated financial statements as of March 31, 2019 and December 31, 2018 and for the three-month periods ended March 31, 2019 and 2018 (“Unaudited Interim Financial Statements” and, together with our Audited Annual Financial Statements, our “Financial Statements”). Our Unaudited Interim Financial Statements have been prepared in accordance with International Accounting Standard (IAS) 34 – “Interim Financial Reporting.” The results for the three-month period ended March 31, 2019 are not necessarily indicative of results to be expected for the entire year ending December 31, 2019.

### Comparability of Historical Financial Information

During 2017 and 2018, we undertook significant transactions that are described below. Consequently, our results of operations and financial condition as of and for the year ended December 31, 2018 may not be comparable to our results of operations and financial conditions as of and for the year ended December 31, 2017, and our results of operations for the three-month period ended March 31, 2019 may not be comparable to our results of operations for the three-month period ended March 31, 2018. The significant transactions that affect the comparability across those periods are the following:

- acquisition of a 42.86% equity interest in Inversora Dock Sud, which holds a 71.78% equity interest in CDS, and a 9.64% equity interest in CDS from YPF on May 26, 2017;
- acquisition of certain assets related to LPC I from Central Puerto S.A. in February 2018, effective as of January 5, 2018;

- sale of our 27.00% interest in the Ramos Area, an oil and gas operation in the Province of Salta, (the “Ramos Area”) to YPF effective as of February 2, 2018, which has been reflected as a discontinued operation in our Financial Statements;
- sale of our 9.64% equity interest in CDS to YPF, effective as of March 1, 2018;
- acquisition of the remaining 33.33% interest in Y-GEN and Y-GEN II from General Electric in connection with General Electric’s acquisition of 24.99% of our equity effective as of March 20, 2018, which we consolidate on a line-by-line basis in our balance sheet since March 31, 2018 and in our income statements and cash flow beginning April 2018, in each case, together with the 66.67% of Y-GEN and Y-GEN II that we owned prior to such acquisition;
- changes in the remuneration paid by CAMMESA to us under Energía Base, effective in February 2017 and March 2019, in relation to our Tucumán Power Plant, San Miguel de Tucumán Power Plant, LPC I (which we acquired in February 2018, effective as of January 5, 2018) and Central Dock Sud power plants; and
- our Loma Campana Este, Loma Campana I, Loma Campana II, El Bracho GT, Manantiales Behr (phase I and phase II) power plants entered into commercial operation in July 2017, November 2017, November 2017, January 2018 and July 2018 (phase I) and December 2018 (phase II), respectively.

### **Functional and Currency Presentation**

In this offering memorandum, references to “dollars,” “U.S. dollars” and “US\$” are to the currency of the United States and references to “Argentine pesos,” “pesos,” or “Ps.” are to the currency of Argentina.

We, based on parameters set out in IAS 21 – “The effects of change in foreign exchange rates”, have defined the U.S. dollar as our functional currency. Consequently, non-monetary cost-based measured assets and liabilities, as well as income or expenses, are remeasured into the functional currency by applying the exchange rate prevailing at the date of the transaction.

Our Financial Statements are presented in Argentine pesos as required under the CNV Rules. In preparing the Financial Statements, with respect to transactions entered into by us or our consolidated subsidiaries, any such transaction in currencies other than the entity’s functional currency (foreign currencies) are recognized at the rates of exchange prevailing on the dates of the transactions. At each reporting date, monetary assets and liabilities that are denominated in foreign currencies are retranslated at the rates prevailing at that date. Non-monetary items carried at fair value that are denominated in foreign currencies are translated at the rates prevailing at the date when the fair value was determined. Non-monetary items that are measured in terms of historical cost in a foreign currency are not retranslated. As we are required to present the Financial Statements in Argentine pesos pursuant to CNV Rules, the amounts resulting from the aforementioned process are to be converted into pesos, according to the criteria specified in IAS 21. Under IAS 21, assets and liabilities should be converted at the applicable closing exchange rate, and results at the exchange rate of the date of each transaction (or, for convenience purposes, and when exchange rates do not vary significantly, at the average exchange rate of each month) and the resulting exchange differences should be recognized in other comprehensive income. For information on our functional and presentation currency, see Note 2.b to our Unaudited Interim Financial Statements and Note 2.3.1 to our Audited Annual Financial Statements.

### **Non-IFRS Financial Measures**

This offering memorandum discloses certain non-IFRS financial measures, being Adjusted EBITDA and Adjusted EBITDA margin. Our adjusted EBITDA has been calculated by adding back to our net profit for the year or period: (i) net financial results, (ii) depreciation of property, plant and equipment, (iii) depreciation of right of use assets and (iv) income tax (the “Adjusted EBITDA”). For a reconciliation of Adjusted EBITDA to net profit see “Selected Financial Data—Non-IFRS Financial Data.” This definition of Adjusted EBITDA may not be the same as the definition used in “Description of the Notes”. Our Adjusted EBITDA margin has been calculated as Adjusted EBITDA divided by continuing and discontinuing operations revenues.

Our management believes that disclosure of Adjusted EBITDA and Adjusted EBITDA margin can provide useful supplemental information to investors and financial analysts in their review of our core operating results. These non-IFRS measures are provided to enhance investors' overall understanding of our current financial performance and its prospects for the future. Specifically, we believe the non-IFRS measures provide useful information to both management and investors by excluding certain expenses, gains and losses, as the case may be, that may not be indicative of our core operating results and business outlook.

Adjusted EBITDA and Adjusted EBITDA margin may not be comparable to other similarly titled measures of other companies and have limitations as an analytical tool and should not be considered in isolation or as a substitute for analysis of our operating results as reported under IFRS. Non-IFRS measures, including Adjusted EBITDA and Adjusted EBITDA margin, are not measurements of our performance or liquidity under IFRS and should not be considered as alternatives to operating profit or net profit, or as alternatives to cash flow from operating activities, in accordance with IFRS.

### **Rounding**

Certain figures (including percentage amounts) included in this offering memorandum have been rounded for ease of presentation. Percentage figures and totals included in this offering memorandum have, in some cases, been calculated on the basis of such figures prior to rounding. For this reason, certain percentage and total amounts in this offering memorandum may vary from those obtained by performing the same calculations using the figures in our Financial Statements and figures shown as total in certain tables may not be an exact arithmetic aggregate of the other figures in the table.

### **Industry and Market Data**

Market data and other statistical information used in this offering memorandum is based on data collected by and available from the Ministry of Economy, the former Ministry of Energy, the Central Bank, the SEE, the INDEC and CAMMESA among other sources. Certain data is also based on our estimates, which are derived from our review of internal surveys as well as independent sources. Although we believe these sources are reliable, we have not independently verified the information and cannot guarantee its accuracy or completeness.

Similarly, internal company surveys, industry forecasts and market research, which we believe to be reliable based upon management's knowledge of the industry, have not been verified by any independent sources. Forecasts are particularly likely to be inaccurate, especially over long periods of time. In addition, we do not know what assumptions were used in preparing the forecasts cited.

### **Argentina Macroeconomic Information**

This offering memorandum includes information derived from publications of, information supplied by, and presentations made by governmental agencies of Argentina and its political subdivisions, as well as independent sources that we believe are reliable, although the accuracy and completeness of such third-party information cannot be guaranteed. None of us, the Initial Purchasers, nor the other entities referred to in this offering memorandum have independently checked the statistical and other information included in this offering memorandum that has been prepared by governmental agencies of Argentina and its political subdivisions or by any other third party and therefore they cannot assure you that such information is accurate or complete. In January 2007, the INDEC, which is the only institution in Argentina with the statutory authority to produce official nationwide statistics, modified the methodology used to calculate certain of its indices. Since then, the credibility of the data published by INDEC has been called into question, particularly with respect to its CPI and GDP, foreign trade data, poverty and unemployment rates. On January 8, 2016, the administration of President Mauricio Macri declared a state of administrative emergency with respect to the national statistical system and INDEC until December 31, 2016. INDEC suspended publication of certain statistical data until completion of a reorganization of its technical and administrative structure to recover its ability to produce sufficient and reliable statistical information. During this reorganization period, INDEC published official CPI figures published by the City of Buenos Aires and the Province of San Luis for reference. On June 15, 2016, INDEC resumed publishing inflation rates using a new methodology for calculating the CPI. On November 9, 2016, the executive board of the IMF lifted its censorship on Argentina. See "Risk Factors—Risks Relating to Argentina".

## TECHNICAL AND REGULATORY TERMS

In this offering memorandum,

- “AESA” means A-Evangelista S.A.
- “AFIP” means the Argentine Public Revenue Administration (*Administración Federal de Ingresos Públicos*).
- “Argentine government” means the Government of the Republic of Argentina.
- “Argentine Supreme Court” means the Argentine Supreme Court of Justice (*Corte Suprema de Justicia de la Nación*).
- “availability factor” means, with respect to a unit, the fraction, expressed in percentage, of a given period of time in which it is available without any outages.
- “BICE” means Banco de Inversión y Comercio Exterior S.A.
- “CAMMESA” means Compañía Administradora del Mercado Mayorista Eléctrico S.A., a nonprofit private stock corporation (*sociedad anónima*), owned by the Argentine government and four other associations that represent the WEM agents with a 20% ownership interest each, which is in charge of the administration of the WEM and the dispatch of electricity into the SADI.
- “CDS” means Central Dock Sud S.A.
- “Central Bank” means the Argentine Central Bank (*Banco Central de la República Argentina*).
- “Central Dock Sud” means the two power generation plants, the Central Dock Sud Combined Cycle and the Central Dock Sud Open Cycle, located in the district of Avellaneda, south of the Buenos Aires Metropolitan Area, in the Province of Buenos Aires, owned by CDS.
- “CNV” means the Argentine Securities Commission (*Comisión Nacional de Valores*).
- “COD” means, with respect to a power plant, the commercial operation date.
- “Combined Cycle” means a thermo-electrical turbine that is capable of using different fuels, including natural gas or gasoil, to drive an alternator that generates electricity, and that then uses the heat released in the process to produce steam and generate additional electricity through a steam turbine.
- “CPI” means the consumer price index.
- “El Bracho GT” means the gas turbine of the El Bracho thermal power plant owned by Y-GEN II.
- “El Bracho ST” means the steam turbine of the El Bracho thermal power plant owned by Y-GEN II.
- “Energía Base” means the regulatory framework set forth in Resolution No. 1/2019 and prior regulations. Such regulations include Resolution No. 95/13, as amended and supplemented, and Resolution No. 19/2017, as amended and supplemented. See “Argentine Electricity Industry and Regulatory Framework.”
- “Energía Plus” means the regulatory framework set forth in Resolution SE No. 1281/06, as amended and supplemented. See “Argentine Electricity Industry and Regulatory Framework.”
- “ENRE” means the Argentine Electricity Regulatory Entity (*Ente Nacional Regulador de la Electricidad*).

- “EPC” means engineering, procurement and construction.
- “EPC Agreement” means the engineering, procurement and construction contracts.
- “EPC Contractor” means the companies that are our counterparties under the EPC Agreements.
- “FODER” means the Trust Fund for Development of Renewable Energy Sources (*Fondo para el Desarrollo de Energías Renovables*), a fund whose assets are allocated to grant loans, make capital contributions and acquire any other financial instruments as required for the execution and financing of projects for the generation of electricity from renewable sources that meet the applicable eligibility requirements.
- “FONINVEMEM” means the Fund for Investments Required to Increase the Electric Power Supply. (*Fondo para Inversiones Necesarias que Permitan Incrementar la Oferta de Energía Eléctrica en el Mercado Eléctrico Mayorista*). See “The Argentine Electricity Power Sector”.
- “GE EFS” means GE EFS Power Investments B.V., an affiliate of General Electric.
- “General Electric” or “GE” means General Electric Corporation, Inc., or any of its subsidiaries and/or affiliates.
- “GUMAs” means major large users (*Grandes Usuarios Mayores*).
- “GUMEs” means minor large users (*Grandes Usuarios Menores*).
- “GUPAs” means particular large users (*Grandes Usuarios Particulares*).
- “GW” means gigawatts.
- “GWh” means gigawatts per hour.
- “HRSG” means heat recovery steam generators.
- “GT” means gas turbine.
- “IDB” means Inter-American Development Bank.
- “IEASA” means *Integración Energética Argentina S.A.* (formerly known as Energía Argentina S.A.).
- “IMF” means the International Monetary Fund.
- “INDEC” means the Argentine Institute of Statistics and Census of the Argentine Republic (*Instituto Nacional de Estadística y Censos de la República Argentina*).
- “Inversora Dock Sud” means Inversora Dock Sud S.A.
- “kV” means kilovolts.
- “KW” means kilowatts.
- “KWh” means kilowatts per hour.
- “Loma Campana Este” means the Loma Campana Este power plant located in the district of Añelo, Province of Neuquén.

- “Loma Campana I” means the Loma Campana I thermal power plant located in the district of Añelo, Province of Neuquén.
- “Loma Campana II” means the Loma Campana II thermal power plant located in the district of Añelo, Province of Neuquén.
- “LPC I” means the co-generation plant located at YPF’s La Plata refinery, which was purchased from Central Puerto S.A.
- “LPC II” means the new co-generation plant located YPF’s La Plata Refinery, which as of the date of this offering memorandum is under construction.
- “LVFVD” means sales receivables without a fixed due date (*liquidaciones de venta con fecha de vencimientos a definir*).
- “MATER” means the Renewable Energy Term Market (*Mercado a Término de Energía Renovable*).
- “MELI” means Free Foreign Exchange Market (*Mercado Libre de Cambios*).
- “Ministry of Energy” or “MEyM” means the former Argentine Ministry of Energy and Mining (*Ministerio de Energía y Minería de la República Argentina*).
- “MULC” means the Single Free Foreign Exchange Market (*Mercado Único y Libre de Cambios*) established in Argentina through Decree No. 27/2018 (replaced by, among other laws, Law No. 27,444) and Communication “A” 6936.
- “MW” means megawatts.
- “MWh” means megawatts per hour.
- “Open Cycle” means a thermo-electrical turbine that is capable of using different fuels, such as natural gas or gasoil, to operate an alternator that generates energy. Unlike Combined Cycle gas turbines, simple cycle gas turbines have only one energy cycle.
- “OPESSA” means Operadora de Estaciones de Servicios S.A.
- “PAT” means the Argentine personal asset tax.
- “PPA” means the capacity and/or power purchase agreements, as applicable, executed between us and our customers.
- “Renewable Energy Law” means the regime introduced by Law No. 26,190 and its modifications, particularly Law No. 27,191.
- “Resolution No. 1/2019” means Resolution No. 1/ 2019 of the Undersecretary of Renewable Resources and Electricity Market.
- “Resolution No. 19/2017” means Resolution No. 19/2017 of the former MEyM’s former Secretary of Electric Energy, currently replaced by Resolution No. 1/2019.
- “Resolution No. 21/2016” means Resolution No. 21/2016 of the former MEyM.
- “Resolution No. 95/2013” means Resolution No. 95/2013 of the former MEyM.

- “Resolution No. 287/2017” means Resolution No. 287/2017 of the former MEyM.
- “SADI” means the Argentine electricity grid (*Sistema Argentino de Interconexión*).
- “San Miguel de Tucumán Power Plant” means the San Miguel de Tucumán Thermal Power Plant located in the district of El Bracho, approximately 22 km south of San Miguel de Tucumán, Province of Tucumán.
- “Secretary of Electric Energy” or “SEE” means the Argentine Secretary of Electric Energy.
- “SGE” means the Government Secretariat of Energy (formerly the Ministry of Electric Energy).
- “Shareholders’ Agreement” means the Shareholders’ Agreement dated March 20, 2018, between GE EFS, YPF, OPESSA and us.
- “Spot Market” means electricity sold by generators to the WEM and remunerated by CAMMESA under the framework in place prior to Energía Base.
- “ST” means steam turbine without reheat.
- “Technical Resolutions” means the resolutions the CNV Rules refer in general as the “*Resoluciones Técnicas*” issued by the Argentine Federation of Professional Councils in Economic Sciences.
- “Thermal Power Plant” means a generation unit that uses heat power derived from fuel, such as natural gas or coal, as an energy source to drive the power generator.
- “Tucumán Complex” means the Tucumán Power Plant and the San Miguel de Tucumán Power Plant.
- “Tucumán Power Plant” means the Tucumán Thermal Power Plant located in the district of El Bracho, approximately 22 km to the south of San Miguel de Tucumán, Province of Tucumán.
- “VAT” means Value Added Tax.
- “Vestas”, as required by the context, means Vestas Wind Systems A/S and Vestas Argentina S.A. or any of their respective affiliates.
- “WEM” or “Wholesale Electricity Market” means the Argentine Wholesale Electricity Market (*Mercado Eléctrico Mayorista de Argentina*).
- “Y-GEN II” means YGEN Eléctrica II S.A.U. (formerly known as YGEN Eléctrica II S.R.L.)
- “Y-GEN” means Y-GEN Eléctrica S.A.U. (formerly known as YGEN Eléctrica II S.R.L.)
- “YPF” means YPF S.A.

Unless otherwise indicated, statistics provided throughout this offering memorandum with respect to power generation units are expressed in MW, in the case of the installed capacity of such power generation units, and in GWh, in the case of the aggregate electricity production of such power generation units. One GW is equal to 1,000 MW and one MW is equal to 1,000 KW. Statistics relating to aggregate annual electricity production are expressed in GWh and are based on a 8,760 hour year.

## SUMMARY

*The following summary highlights certain important information in this offering memorandum. However, it does not contain all of the information that may be important to you in making a decision to invest in the Notes. We urge you to read and review carefully this entire offering memorandum, in particular, the sections entitled “Risk Factors” and “Management’s Discussion and Analysis of Financial Condition and Results of Operations” and the Financial Statements included herein, in order to fully understand our business and this offering.*

### Overview

We are a leading Argentine power company, primarily engaged in the development and generation of electrical power from both conventional (thermal) and renewable (wind, solar and biomass) sources. As of the date of this offering memorandum, we have nine power plants with a total net installed capacity of 1,819 MW, including our 30.76% equity interest in the Central Dock Sud plant, which consists of Combined Cycle turbines with an installed capacity of 797.5 MW and two Open Cycle turbines with an installed capacity of 36 MW each. Since July 2017, we have added through development or acquisition 723 MW to our power plants currently under operation.

We also have multiple projects under construction totaling 634 MW of installed capacity, including wind farms and thermal power plants, that are scheduled to commence operations in 2020, and substantially all of which have signed or been awarded PPAs.

We were formed in August 2013 as a result of a spin-off from Pluspetrol Energy S.A. and contribution of two of our power plants and certain other assets by YPF as our shareholder. YPF is Argentina’s largest energy company with fully integrated oil and gas operations, maintaining leading market positions in both upstream and downstream segments, and is majority state-owned and has been listed on the Buenos Aires Stock Exchange and the New York Stock Exchange since 1993. Since our formation we have been focused on improving the operational efficiency and reliability of our power plants and developing new projects. Additionally, we strive to be a leading electricity generating company in the country and a leader in renewable energies, dedicated to maintaining high security, technology, efficiency and quality standards. As part of our strategy to continue to grow our business, in March 2018, an affiliate of General Electric subscribed for 24.99% of our capital stock, with the remaining percentage held by YPF. General Electric is a 126-year old diversified industrial company with operations in more than 180 countries and businesses spanning across the energy, aviation and healthcare sectors.

Our portfolio of operating and under-construction generation assets benefits from diversification of technology, offtakers and geographic locations within Argentina. Our thermal power plants and thermal projects include Combined Cycle turbines, Open Cycle turbines, co-generation turbines and motor-generators. Our renewable projects under construction consist of wind farms and our development pipeline includes solar photovoltaic and biomass projects. Our operating power plants and wind farms, together with our projects under construction, have as offtakers not only CAMMESA (the entity that manages the administrative and technical energy supply and demand of SADI) but also YPF and other large private users, which we expect to become an increasingly important part of our client portfolio. In 2018, Energía Base revenues represented 45.9% of our revenue, while revenue under our PPAs with CAMMESA represented 36.7% and revenue under PPAs with other large users, private clients, steam sales, and others represented 17.5%.

During the three-month period ended March 31, 2019, we had revenues of Ps. 2,691.7 million, net profit of Ps. 1,117.3 million and Adjusted EBITDA of Ps. 2,251.3 million, with an Adjusted EBITDA margin of 83.64%. During the year ended December 31, 2018, we had revenues of Ps. 7,124.9 million, net profit of Ps. 4,505.4 million and Adjusted EBITDA of Ps. 7,530.3 million, with an Adjusted EBITDA margin of 105.08%. For a reconciliation of Adjusted EBITDA to net profit see “Selected Financial Data—Non-IFRS Financial Data.”

We currently have eight thermal plants and one wind farm in operation, including our equity interest in the Central Dock Sud plant. The following table presents a brief description of our operating power plants and wind farm.



<b>Plant</b>	<b>Location</b>	<b>Installed capacity (MW)</b>	<b>Regulatory Framework / Offtaker</b>	<b>Technology</b>	<b>COD</b>	<b>Expiration date of PPA</b>
Tucumán Power Plant <sup>(1)</sup> ...	Province of Tucumán	447	Energía Base <sup>(6)</sup>	Combined Cycle	1996/1997	N/A
San Miguel de Tucumán Power Plant <sup>(1)</sup> .....	Province of Tucumán	382	Energía Base <sup>(6)</sup>	Combined Cycle	1995/2000	N/A
El Bracho GT <sup>(1)(2)</sup> .....	Province of Tucumán	267	PPA with CAMMESA <sup>(7)</sup>	Open Cycle	January 2018	January 26, 2028
Loma Campana I .....	Province of Neuquén	105	YPF <sup>(8)</sup>	Open Cycle	November 2017	November 15, 2032
Loma Campana II .....	Province of Neuquén	107	PPA with CAMMESA <sup>(7)</sup>	Open Cycle	November 2017	November 29, 2027
Loma Campana Este <sup>(3)</sup> .....	Province of Neuquén	17	YPF <sup>(8)</sup>	Motor generator	July 2017	July 11, 2020
LPC I <sup>(4)</sup> .....	Province of Buenos Aires	128	Energía Base <sup>(6)</sup>	Cogeneration	1997	N/A
Manantiales Behr .....	Province of Chubut	99	PPA with YPF and other industrial clients <sup>(9)</sup>	Wind farm	July/December 2018	Several PPAs <sup>(9)</sup>
Central Dock Sud .....	Province of Buenos Aires	267 <sup>(5)</sup>	Energía Base <sup>(6)</sup>	Combined Cycle/ Open Cycle	1989/2000	N/A
<b>Total.....</b>		<b>1,819</b>				

(1) Part of the “Tucumán Complex.”

(2) El Bracho ST Combined Cycle is under construction and is expected to start commercial operations in the fourth quarter of 2020. For reasons beyond our control, we may not commence commercial operations as required under the applicable PPA. See “Business—Our Projects—Thermal Energy—El Bracho ST”.

(3) Not connected to the SADI.

(4) Acquired from Central Puerto S.A. in February 2018, effective as of January 5, 2018. The LPC I power plant also produces between 190 and 210 tons of steam per hour, which are sold to YPF.

(5) Represents our 30.76% indirect equity interest in CDS, a power plant located in the Province of Buenos Aires and operated by Enel S.A., with an installed capacity of 797.5 MW of Combined Cycle turbines and 72 MW of installed capacity for two Open Cycle turbines (36 MW each).

(6) Resolution No. 1/2019.

(7) Resolution No. 21/2016.

(8) Self-generation.

(9) The generation under this wind farm is committed under nine PPAs with the private sector. The terms of such PPAs are from 5 to 21 years with a weighted average term of 11.5 years.

We have developed a significant pipeline of new energy projects with a team that has expertise in the entire cycle of electrical power generation, from prospecting and developing projects to constructing, operating and marketing power plants for both conventional and renewable generation. We are currently in the process of constructing three wind farms, two of which are located in the Province of Buenos Aires and one of which is located in the Province of Santa Cruz. We are also in the process of converting the El Bracho GT power plant into a Combined Cycle power plant with high power and efficiency combustion motors technology and we are constructing a cogeneration plant in the Province of Buenos Aires for industrial processes. The following table presents a brief description of our projects under construction, which requires an estimated total investment of approximately US\$915 million.

<u>Plant</u>	<u>Location</u>	<u>Additional Installed Capacity (MW)</u>	<u>Offtaker</u>	<u>Technology</u>	<u>Expected COD</u>	<u>Estimated Total Capital Expenditures</u>
Los Teros I .....	Province of Buenos Aires	123	MATER	Wind farm	1st quarter 2020	US\$165.5 million
LPC II.....	Province of Buenos Aires	85	CAMMESA	Cogeneration	2nd quarter 2020	US\$166 million
Cañadón León .....	Province of Santa Cruz	120	CAMMESA	Wind farm	3rd quarter 2020	US\$165 million
El Bracho ST .....	Province of Tucumán	198	CAMMESA	Steam Turbine	4 <sup>th</sup> quarter 2020 <sup>(1)</sup>	US\$290 million
Manantiales Behr Thermal Plant .....	Province of Chubut	58	YPF	Motor generator	4th quarter 2020	US\$63.2 million
Los Teros II .....	Province of Buenos Aires	50	MATER	Wind farm	4th quarter 2020	US\$65 million
<b>Total.....</b>		<b>634</b>				<b>US\$914.7 million</b>

(1) Closing cycle of our El Bracho GT power plant will increase its installed power capacity by 198 MW. For reasons beyond our control, we may not commence commercial operations before August, 2019 as required under the applicable PPA. See “Business–Our Projects–Thermal Energy–El Bracho ST”.

Our operating power plants, wind farm and projects under construction are located in the provinces of Tucumán, in the northern region of Argentina, Neuquén, in the southern region of Argentina, Buenos Aires, in the center of the country, and Chubut and Santa Cruz, in the southern region of Argentina, which ensures us proximity to users and access to multiple nodes of the SADI. The following map shows the location of operating power plants, farms and projects under construction.

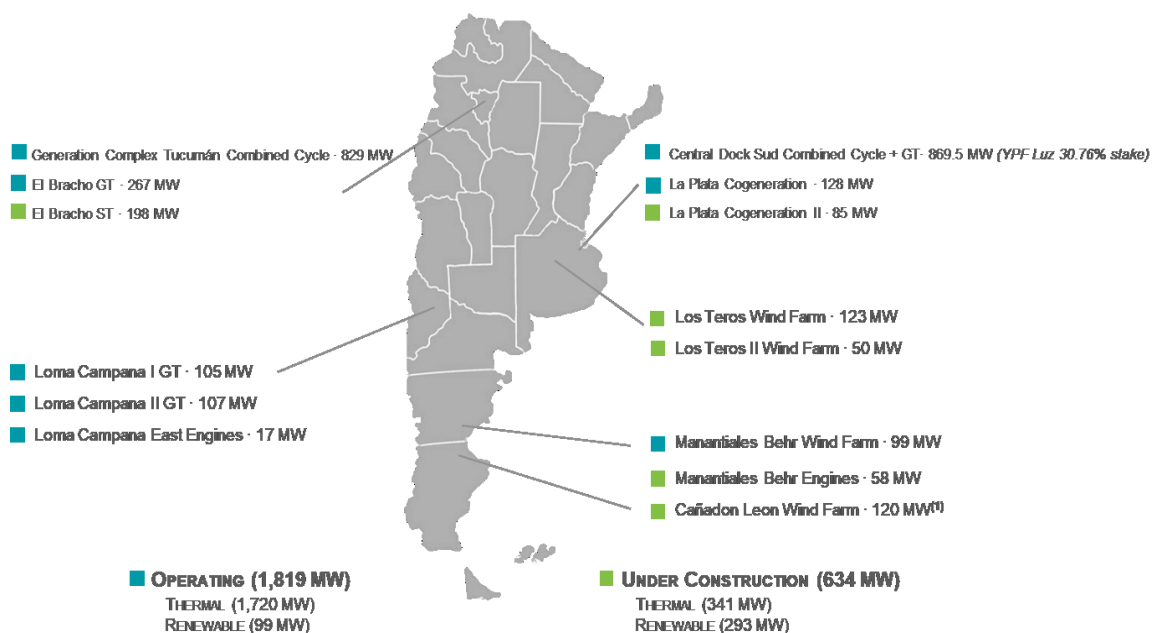

During the year ended December 31, 2018, our revenues under our PPAs and Energía Base accounted for 48.4% and 45.9% of our revenues, respectively, and during the three-month period ended March 31, 2019, our revenues under our PPAs and Energía Base accounted for 60.5% and 34.4% of our revenues, respectively, with the remaining percentage coming mainly from our steam sales and other services.

We have entered into long-term PPAs with CAMMESA for El Bracho GT and Loma Campana II power plants and with YPF for Loma Campana Este and Loma Campana I power plants. Furthermore, as of the date of this

offering memorandum, the weighted average remaining life of our PPAs for all of our operating thermal power plants is approximately 13 years. In relation to our projects under construction, we have entered into PPAs with CAMMESA for LPC II, El Bracho ST and Cañadón León and with YPF for the Manantiales Behr motor project. In addition, we have commenced entering into PPAs with other private large users in the MATER, which we believe are some of the most creditworthy groups in Argentina. The weighted average remaining life of our PPAs, including the PPAs for our projects under construction, is approximately 16 years (for our wind farms, based on the expected P50 load factor).

Our Tucumán, San Miguel de Tucumán, LPC I and Central Dock Sud power plants are dispatched under Energía Base. Energía Base applies typically to older plants in Argentina with compensation depending primarily on the availability of the plants adjusted based on the electricity dispatched. Tariffs under Energía Base are paid by CAMMESA and adjusted by resolution of the Secretary of Energy. From February 2017 to March 2019, Energía Base was regulated by Resolution No. 19/17, which significantly increased tariffs and denominated them in U.S. dollars. Resolution No. 19/17 was replaced by Resolution No. 1/2019, which maintained the tariffs denominated in U.S. dollars but adjusted the fixed remuneration of availability based on the electricity effectively dispatched by the relevant unit. Under Energía Base, the fuel required to produce the energy we generate is currently supplied by CAMMESA free of charge, and the price we receive as generators is determined without accounting for the natural gas or fuel CAMMESA supplies.

We also produce steam in our LPC I power plant, which we acquired in February 2018, effective as of January 5, 2018, and has an installed capacity of between 190 and 210 tons of steam per hour. We sell the steam to YPF under a 15-year steam supply agreement, which we entered into in January 2018. Our revenues from steam sales for the three-month period ended March 31, 2019 and the year ended December 31, 2018 were Ps. 136.3 million and Ps. 386.5 million, respectively (434,417 metric tons and 1,621,868 metric tons, respectively), which represented 5.1% and 5.4%, respectively, of our revenues for such period.

Our power generation plants are reliable and efficient for Argentina's energy sector. Our Loma Campana I, Loma Campana II and Loma Campana Este power plants, located in the area of unconventional hydrocarbons exploitation known as "Vaca Muerta" in the Province of Neuquén, began commercial operations on November 15, 2017, November 30, 2017 and July 13, 2017, respectively, and have an installed capacity of 105 MW, 107 MW and 17 MW, respectively. In Loma Campana I and Loma Campana II we operate General Electric Open Cycle aeroderivative gas turbines, model LMS-100, one of the most efficient gas technologies available in the market, that are connected to the SADI, while in Loma Campana Este, located within YPF's premises in Neuquén, we operate Jenbacher gas motor generators, model J-420, that are not connected to the SADI since we provide the energy they produce, as self-generator, directly to YPF. For the year ended December 31, 2018, the availability factor was 59%, 86% and 99.6%, respectively.

Our El Bracho GT power plant has one gas turbine provided by General Electric with an installed capacity of 267 MW. This plant reached commercial operation on January 27, 2018 and achieved an availability factor of 97% for the year ended December 31, 2018. El Bracho GT is located in the Province of Tucumán and is part of our Tucumán Complex that encompasses our Tucumán and San Miguel de Tucumán power plants. Our Tucumán Power Plant is a Combined Cycle plant with two Siemens gas turbines, a General Electric steam turbine and two Nooter Eriksen's HRSGs with a total installed capacity of 447 MW. Our San Miguel de Tucumán Power Plant is also a Combined Cycle power plant with two General Electric gas turbines, an Alstom steam turbine and two Cockerill Maintenance & Ingénierie ("CMI") HRSGs steam turbines with a combined installed capacity of 382 MW. Our Tucumán and San Miguel de Tucumán power plants had an availability factor of 99% and 97%, respectively, during the year ended December 31, 2018. In February 2018, effective as of January 5, 2018, we acquired LPC I, a power plant located in the Province of Buenos Aires and within YPF's refinery. The plant has an installed capacity of 128 MW and produces from 190 to 210 tons of steam per hour.

We own a 30.76% indirect equity interest in CDS, a power plant located in the Province of Buenos Aires with an installed capacity of 797.5 MW of Combined Cycle turbines and 72 MW of installed capacity for two Open Cycle turbines (36 MW each). The plant is operated by Enel S.A.

## Our Strengths

**Reliable high-quality generation assets which are technologically and geographically diverse.** We have eight high-quality operating thermal plants, a wind farm which ranks among the best of its type in terms of generation records, and three thermal projects under construction in which we will operate Combined Cycle turbines, co-generation turbines and motor-generators. We also have three wind farm projects under construction, Los Teros I and Los Teros II, both in the Province of Buenos Aires, and Cañadón León in the Province of Santa Cruz. Also, our development pipeline includes solar power, biomass, and thermal motor generators and Combined Cycle projects, among others. Our thermal operating plants have relatively high efficiency levels due to the use of modern technologies combined with regular maintenance conducted by our highly trained employees and prime technology and maintenance suppliers, such as General Electric. Our thermal power plants had a weighted average availability factor of 91% during the year ended December 31, 2018. Moreover, our wind farms under construction are located in areas with very favorable wind conditions and they each have an expected load factor in excess of 50%. Our operating plants and projects under construction are located in the northern, central and southern regions of Argentina, gives us flexibility to dispatch energy into SADI at different interconnection points and protects our portfolio from transmission restrictions in the SADI derived from system failures and the installation of new capacity.

**New projects to support growth and increase profitability.** Our successful track record in recent auctions held by the Argentine government, industrial clients and YPF, together with the timely construction and commencement of operations of our new operating power plants and wind farm, our operating efficiency and safety have proven our ability to source, win and develop new projects at competitive energy prices, meet construction deadlines, and operate and maintain our power plants in accordance with industry standards. Over the past three years, we have been awarded over 13% of the total MW of installed capacity awarded by CAMMESA through long-term PPAs. We currently have 634 MW of capacity under construction consisting of 341 MW of thermal power and 293 MW of renewable energy, which are expected to begin commercial operation in mid 2020. In addition, we have a pipeline of additional projects that we expect to commit in future tenders or offer to large private users that seek to supply their energy needs from renewables.

**Renowned local and international sponsors.** YPF and General Electric are, directly or indirectly, beneficial owners of 75.01% and 24.99% of our capital stock, respectively. YPF is Argentina's largest energy company operating a fully integrated oil and gas chain, with leading market positions in both upstream and downstream segments, and is majority state-owned and listed on the Buenos Aires Stock Exchange and in the New York Stock Exchange since 1993. YPF is also one of the largest users of electricity in Argentina and is the country's largest private offtaker, with PPAs for more than 180 MW of installed capacity. General Electric is a 126-year old diversified industrial company with operations in more than 180 countries and businesses spanning across the aviation, energy and healthcare sectors. Our shareholders provide significant support for our plants and expansion plans, providing technology and technical support needed to pursue our objectives.

**Strong and growing cash flow generation, supported by U.S. dollar denominated cash flows.** Our revenues mainly derive from long-term U.S. dollar-denominated PPAs and Energía Base. Revenues from our newer power plants are derived from U.S. dollar denominated PPAs with CAMMESA and YPF, with terms ranging from 10 to 20 years (except for the agreement for Loma Campana Este which has a term of three years). Our existing PPAs for our thermal power plants provide for payments for available capacity and for electricity effectively generated and dispatched. On the other hand, our Manantiales Behr wind farm has U.S. dollar denominated long-term PPAs for 100% of its generation capacity with YPF and other different industrial clients. In addition, since February 2017, the remuneration under Energía Base is denominated in U.S. dollars, which encompasses nearly 67% of our installed capacity as of March 31, 2019. We also have three thermal plants and three wind farms under construction, whose revenues will mainly derive from U.S. dollar denominated PPAs that we have signed. The revenues from the renewable energy projects' PPAs, which have an expected load factor greater than 50%, will derive from the amount of energy dispatched since such projects benefit from dispatch priority granted by CAMMESA. By the end of 2020, we expect that approximately 39% and 41% of our revenue will derive from PPAs with private offtakers (including YPF) and CAMMESA, respectively, and the remaining 20% from Energía Base.

**Strong management team and high-quality workforce.** Our management team has extensive industry and financial experience, including over 20 years of experience in the Argentine energy sector. We believe that our management team has been successful in identifying attractive investment opportunities, structuring innovative

business plans and completing complex transactions efficiently, as demonstrated by our considerable expansion since our inception in 2013 (from 829 MW of installed capacity at our inception in 2013 to 1,819 MW as of the date of this offering memorandum) as well as the amount and diversity of our projects currently under construction (634 MW of projects under construction as of the date of this offering memorandum). We also believe that our workforce has the experience, knowledge and training adequate to operate and maintain our operating assets while improving our efficiency levels. This combination of experienced management and a highly skilled technical and operative workforce contributes to our ability to efficiently operate our assets, identify and evaluate high-quality growth opportunities and integrate new businesses that are acquired or developed, and, therefore, make our company efficient and profitable.

## **Our Strategy**

Our mission is to be a profitable, efficient and sustainable power company, focused on optimizing natural resources and contributing to the development of the energy industry in Argentina and the markets in which we operate. Our vision is to be one of the major companies in the country's electricity generation sector, a leader in renewable energies with worldwide safety, technology, efficiency and quality standards.

Despite having a track record of only almost six years in the power generation market, we have generated a results-oriented culture based on the values of commitment, sustainability, passion, team work and agility, and we have managed to become one of the major players in the Argentine power generation sector. We are strongly committed to addressing Argentina's expected growth in demand in the long term and to the creation of value for our shareholders and other stakeholders. We plan to continue to invest in growing our generation asset portfolio in a balanced, diversified and integrated manner by taking advantage of available opportunities that provide competitive returns.

Our 2019-2023 strategic plan is based on significantly increasing our installed capacity of efficient thermal and renewable generation both through new developments and opportunistic acquisitions.

We have established the following strategic guidelines to carry out our plan:

- sustainable growth with profitability and financial discipline;
- seek leadership in the generation market with a focus on renewable energies;
- provide competitive energy solutions for our customers;
- operations and processes that are efficient, reliable, transparent, complete and safe;
- develop and strengthen our management and employees as a differentiating element; and
- social and environmental sustainability in our operations.

Objectives are grouped into four categories, as follows:

### *Financial:*

- grow in a sustainable way with profitability and generation of value; and
- maintain financial solvency to allow for growth opportunities.

### *Marketing:*

- increase market share with leadership in renewables;
- develop our portfolio of clients with private PPAs;

- be the sole energy supplier of YPF; and
- develop other business opportunities to ensure sustainability.

*Internal processes:*

- achieve competitive costs while seeking efficiency in operations;
- establish effective communication with all interested parties;
- manage efficiently and in compliance with applicable regulations, policies and processes; and
- achieve excellence in social and environmental sustainability of our operations.

*Human resources:*

- assemble a solid and well consolidated team;
- maintain a high level of technical knowledge and professionalism;
- strengthen leadership; and
- be proud of being part of the team.

**Corporate Structure**

The following chart summarizes our corporate structure as of the date of this offering memorandum:

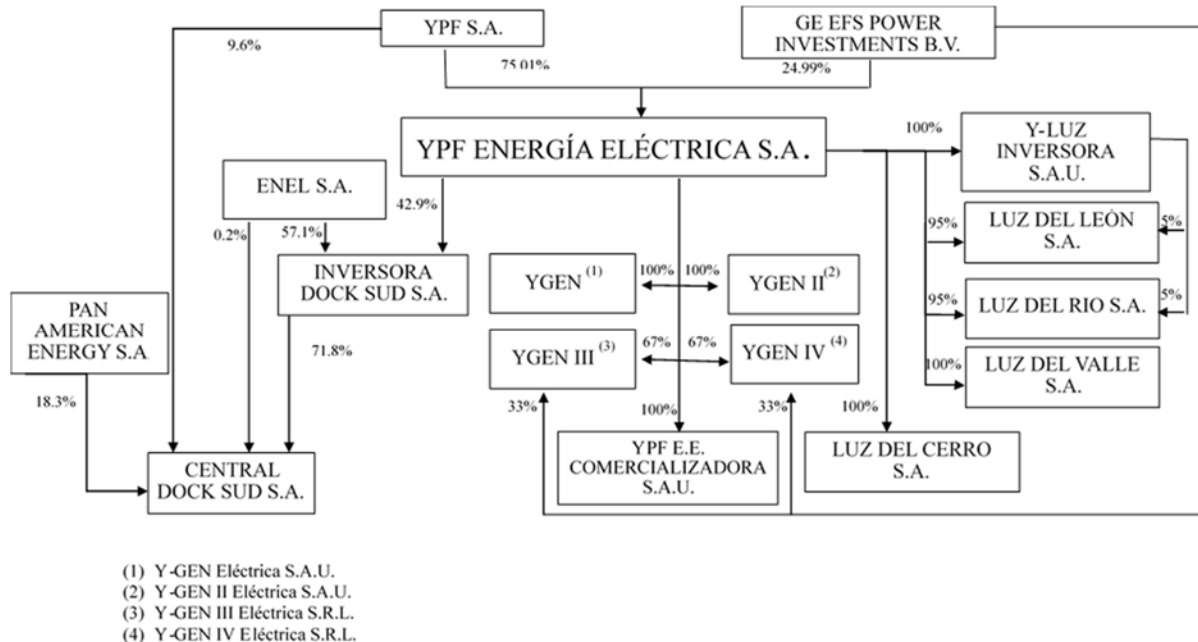

**Recent Events**

On May 10, 2019 and June 12, 2019, under the terms of the Program, we issued US\$75 million and US\$25 million, respectively, of notes due 2021 with a 10.24% coupon under Argentine law. Under the terms of such notes,

we will make quarterly interest payments in arrears on each interest payment date starting on August 10, 2019. The notes mature on May 10, 2021.

**Contact Information**

Our main administrative offices are located at Avenida Cordoba 111, (C1054AAA), Buenos Aires, Argentina; our phone number is (+5411) 5441-5400; and our e-mail address is [inversores.ypfee@ypf.com](mailto:inversores.ypfee@ypf.com). Our web site is [www.ypfluz.com](http://www.ypfluz.com). None of the information on or connected to our website is incorporated by reference into this offering memorandum.

## Summary Financial and Operating Data

The following tables present summary financial and operating data as of March 31, 2019 and for the three-month periods ended March 31, 2019 and 2018, which financial data is derived from our Unaudited Interim Financial Statements, and summary financial and operating data as of December 31, 2018, and 2017 and January 1, 2017 and for the years ended December 31, 2018 and 2017, which financial data is derived from our Audited Annual Financial Statements. The summary financial and operating data included herein is qualified in its entirety and should be read together with our Financial Statements as well as the sections entitled “Presentation of Financial and Other Information” and “Management’s Discussion and Analysis of Financial Condition and Results of Operations.”

Our Financial Statements were prepared on a consolidated basis in accordance with IFRS. We used a transition date of January 1, 2017 and, therefore, our Audited Annual Financial Statements as of December 31, 2018 and 2017 and January 1, 2017 and for the years ended December 31, 2018 and 2017 are our first audited annual consolidated financial statements to be prepared in accordance with IFRS. IFRS 1—First-time Adoption of International Financial Reporting Standards governs the adoption of IFRS and first-time preparation of consolidated financial statements and provides for certain exceptions and exemptions. See Note 2.5 to our Annual Financial Statements for a description of the effects of adopting IFRS.

We undertook certain significant transactions which may affect the comparability of our results of operations across the periods presented herein. Therefore, our results of operations for the year ended December 31, 2018 may not be comparable to our results of operations for the year ended December 31, 2017 and, our results of operations for the three-month period ended March 31, 2019 may not be comparable to our results of operations for the three-month period ended March 31, 2018. For a summary of those transactions, see “Presentation of Financial and Other Information” in this offering memorandum.

### Summary Financial Data

#### Consolidated Statements of Comprehensive Income

	For the three-month period ended March 31,		For the year ended December 31,	
	2019	2018	2018	2017
	(in thousands of Ps.)			
Revenues .....	2,691,682	644,389	7,124,905	1,470,670
Production costs .....	(892,818)	(233,720)	(2,401,625)	(443,646)
<b>Gross profit</b> .....	<b>1,798,864</b>	<b>410,669</b>	<b>4,723,280</b>	<b>1,027,024</b>
Administrative and selling expenses .....	(247,766)	(49,217)	(544,414)	(183,508)
Remeasurement of pre-existing equity interest .....	—	1,785,033	1,785,033	-
Other net operating results .....	33,838	(294)	(292)	(723)
<b>Operating profit</b> .....	<b>1,584,936</b>	<b>2,146,191</b>	<b>5,963,607</b>	<b>842,793</b>
Income from equity interest in associates .....	131,146	43,937	268,015	67,503
Finance income .....	515,756	269,750	1,285,441	208,769
Finance loss .....	(917,487)	(442,893)	(2,607,963)	(197,190)
Net financial results .....	(401,731)	(173,143)	(1,322,522)	11,579
<b>Profit before income tax from continuing operations</b> .....	<b>1,314,351</b>	<b>2,016,985</b>	<b>4,909,100</b>	<b>921,875</b>
Income tax .....	(197,080)	(113,147)	(416,984)	(269,105)
<b>Net profit for the period/year from continuing operations</b> .....	<b>1,117,271</b>	<b>1,903,838</b>	<b>4,492,116</b>	<b>652,770</b>
Profit after income tax for the period/year from discontinued operations .....	—	13,296	13,296	193,987
<b>Net profit for the period/year</b> .....	<b>1,117,271</b>	<b>1,917,134</b>	<b>4,505,412</b>	<b>846,757</b>
<b>Other comprehensive income for the period/year</b>				
Items that may be reclassified to net profit in subsequent periods				-
Fair value changes on derivative instruments, net of tax effects .....	(26,173)	24,810	26,391	-
Items that may not be reclassified to net profit in subsequent periods				
Translation differences .....	3,933,824	332,988	11,170,660	542,191



	For the three-month period ended		For the year ended	
	March 31,		December 31,	
	2019	2018	2018	2017
	(in thousands of Ps.)			
<b>Net variation of other comprehensive income for the period/year .....</b>	<b>3,907,651</b>	<b>357,798</b>	<b>11,197,051</b>	<b>542,191</b>
<b>Total comprehensive income for the period/year .....</b>	<b>5,024,922</b>	<b>2,274,932</b>	<b>15,702,463</b>	<b>1,388,948</b>
Net profit for the period attributable to shareholders	1,117,271	1,917,134	4,505,412	846,757
Continuing operations.....	1,117,271	1,903,838	4,492,116	652,770
Discontinued operations .....	—	13,296	13,296	193,987
<b>Total comprehensive income for the period/year attributable to shareholders .....</b>	<b>5,024,922</b>	<b>2,274,932</b>	<b>15,702,463</b>	<b>1,388,948</b>
Continuing operations.....	5,024,922	2,261,636	15,689,167	1,194,961
Discontinued operations .....	—	13,296	13,296	193,987

### Consolidated Balance Sheet Data

	As of March 31,	As of December 31,		As of January 1,
	2019	2018	2017	2017
	(in thousands of Ps.)			
<b>Assets</b>				
<b>Non-current Assets</b>				
Property, plant and equipment.....	48,503,937	37,650,465	5,234,723	1,941,058
Intangible assets .....	224,419	196,835	—	—
Right of use asset .....	527,130	—	—	—
Investments in associates and joint ventures .....	2,386,115	1,948,492	2,424,677	459,326
Other receivables .....	2,582,507	1,846,127	623,638	802,708
Investment in financial assets .....	41,571	69,901	—	—
Deferred income tax assets .....	36,029	54,153	—	—
<b>Total non-current assets .....</b>	<b>54,301,708</b>	<b>41,765,973</b>	<b>8,283,038</b>	<b>3,203,092</b>
<b>Current Assets</b>				
Inventories.....	—	—	585	256
Other receivables .....	1,626,910	6,234,304	255,428	212,603
Trade receivables .....	3,451,571	3,724,234	707,855	372,205
Other financial assets.....	1,750,466	1,489,031	—	—
Cash and cash equivalents .....	7,632,835	4,701,336	139,082	651,447
<b>Total current assets .....</b>	<b>14,461,782</b>	<b>16,148,905</b>	<b>1,102,950</b>	<b>1,236,511</b>
<b>Total Assets.....</b>	<b>68,763,490</b>	<b>57,914,878</b>	<b>9,385,988</b>	<b>4,439,603</b>
<b>Liabilities</b>				
<b>Non-current Liabilities</b>				
Provisions.....	38,122	35,421	91,261	63,447
Deferred income tax liability.....	2,849,236	2,430,623	347,288	157,886
Leases liabilities.....	358,553	—	—	—
Loans.....	20,943,971	18,256,570	3,088,604	1,679,560
Other liabilities .....	—	—	—	200
<b>Total Non-current liabilities .....</b>	<b>24,189,882</b>	<b>20,722,614</b>	<b>3,527,153</b>	<b>1,901,093</b>
<b>Current Liabilities</b>				
<b>Provisions</b>	—	—	14,594	12,219
<b>Income Tax Payable</b>	—	—	—	42,630
Taxes payable .....	281,960	340,436	11,839	65,002
Salaries and social security.....	136,040	151,256	47,012	22,881
Leases liabilities.....	100,748	—	—	—
Loans.....	6,809,814	6,514,408	992,375	8,985
Other liabilities .....	110,610	99,359	200	—
Accounts payable .....	6,588,238	4,565,529	879,428	639,388
<b>Total current liabilities .....</b>	<b>14,027,410</b>	<b>11,670,988</b>	<b>1,945,448</b>	<b>791,105</b>
<b>Total Liabilities .....</b>	<b>38,217,292</b>	<b>32,393,602</b>	<b>5,472,601</b>	<b>2,692,198</b>
<b>Shareholders' Equity</b>				
Shareholders' contributions.....	8,411,982	8,411,982	2,506,556	58,816
Reserves, other comprehensive income and retained earnings .....	22,134,216	17,109,294	1,406,831	1,688,589
<b>Total Shareholders' Equity .....</b>	<b>30,546,198</b>	<b>25,521,276</b>	<b>3,913,387</b>	<b>1,747,405</b>

## Non-IFRS Financial Data

	For the three-month period ended March 31,		For the year ended December 31,	
	2019	2018	2018	2017
	(in thousand of Ps, except percentages)		(in thousand of Ps., except percentages)	
Adjusted EBITDA <sup>(1)</sup> .....	2,251,299	2,274,908	7,530,273	1,289,972
Adjusted EBITDA margin <sup>(2)</sup> .....	83.64%	331.67%	105.08%	67.17%

- (1) We calculate Adjusted EBITDA by adding back to our net profit for the period/year: (i) net financial results, (ii) depreciation of property, plant and equipment, (iii) depreciation of right of use assets and (iv) income tax. Adjusted EBITDA is not a presentation made in accordance with IFRS. Adjusted EBITDA may not be comparable to other similarly titled measures of other companies and has limitations as an analytical tool and should not be considered in isolation or as a substitute for analysis of our operating results as reported under IFRS. For a reconciliation of Adjusted EBITDA to net profit see "Selected Financial Data—Non-IFRS Financial Data."
- (2) Adjusted EBITDA margin has been calculated by dividing Adjusted EBITDA by revenues for the period or year.

## Operating Data

The following table presents certain of our operating data for the periods indicated.

	For the three-month period ended March 31,		For the year ended December 31,	
	2019	2018	2018	2017
<b>Availability Factor (%)</b>				
Tucumán Power Plant .....	101%	101%	99%	87%
San Miguel de Tucumán Power Plant .....	101%	94%	97%	89%
El Bracho GT <sup>(1)</sup> .....	98%	95%	97%	-
Loma Campana I <sup>(2)</sup> .....	94%	10%	59%	32%
Loma Campana II <sup>(3)</sup> .....	100%	58%	86%	56%
Loma Campana Este <sup>(4)</sup> .....	100%	99%	100%	98%
LPC I <sup>(5)</sup> .....	95%	104%	96%	-
Manantiales Behr Wind Farm <sup>(6)</sup> .....	100%	-	96%	-
Central Dock Sud <sup>(7)</sup> .....	83%	92%	71%	87%
<b>Energy Sales (GWh)</b>				
Tucumán Power Plant .....	522	835	3,024	2,796
San Miguel de Tucumán Power Plant .....	280	591	2,208	2,501
El Bracho GT <sup>(1)</sup> .....	242	24	543	-
Loma Campana I <sup>(2)</sup> .....	183	21	432	49
Loma Campana II <sup>(3)</sup> .....	143	75	396	65
Loma Campana Este <sup>(4)</sup> .....	10	8	34	9
LPC I <sup>(5)</sup> .....	215	227	873	-
Manantiales Behr Wind Farm <sup>(6)</sup> .....	124	-	145	-
Central Dock Sud <sup>(7)</sup> .....	1,066	1,461	3,495	4,944
<b>Total energy sales</b> .....	<b>2,568</b>	<b>3,460</b>	<b>11,150</b>	<b>10,364</b>

- (1) Began commercial operation on January 27, 2018.
- (2) Began commercial operation on November 15, 2017.
- (3) Began commercial operation on November 30, 2017.
- (4) Began commercial operation on July 13, 2017.
- (5) We acquired the LPC I power plant from Central Puerto S.A. in February 2018, effective as of January 5, 2018. LPC I also sold 0.435 million tons of steam during the year ended December 31, 2018.
- (6) Began partial commercial operation on July 25, 2018 and full commercial operation on December 22, 2018.
- (7) We own a 30.76% indirect equity interest in CDS, a power plant located in the Province of Buenos Aires and operated by Enel S.A., with an installed capacity of 797.5 MW of Combined Cycle turbines and 72 MW of installed capacity for two Open Cycle turbines (36 MW each).

## The Offering

The following summary contains basic information about the Notes and is not intended to be complete. For a more complete understanding of the Notes, see “Description of the Notes” in this offering memorandum.

Issuer .....	YPF Energía Eléctrica S.A.
Notes Offered .....	US\$400,000,000 aggregate principal amount of 10.000% senior notes due July 25, 2026
Issue Date .....	July 25, 2019
Issue Price .....	98.772% of the principal amount, plus accrued interest, if any, from July 25, 2019
Maturity Date .....	July 25, 2026
Interest Rate .....	10.000% per year. Interest will be computed on a 360-day year and 30-day month basis.
Interest Payment Dates.....	Interest will accrue from the issue date and will be paid on January 25 and July 25 of each year, commencing on January 25, 2020.
Status and Ranking.....	<p>The Notes will constitute “<i>obligaciones negociables simples no convertibles en acciones</i>” under Argentine law, and will be issued pursuant to, and in compliance with, all the requirements of Argentine Negotiable Obligations Law and any other applicable Argentine laws and regulations. The Notes will be the Issuer’s direct, unconditional, unsecured and unsubordinated obligations and will:</p> <ul style="list-style-type: none"><li>• rank equal in right of payment with all of the Issuer’s existing and future unsecured and unsubordinated indebtedness (except those obligations preferred by statute operation of Argentine law, including without limitation labor and tax claims);</li><li>• rank senior in right of payment to any future subordinated indebtedness of the Issuer;</li><li>• be effectively subordinated to all of the Issuer’s existing and future secured indebtedness to the extent of the value of the assets securing such indebtedness; and</li><li>• be effectively subordinated to all existing and future indebtedness and other liabilities of the Issuer’s subsidiaries.</li></ul> <p>As of March 31, 2019, we had unsecured outstanding loans for US\$458.7 million and secured loans for US\$185 million, for an aggregate amount of US\$643.7 million. See “Management’s discussion and analysis of financial conditions and results of operations — Indebtedness”.</p>
Withholding Taxes; Additional Amounts ....	The Issuer will make payments in respect of Notes without withholding or deductions for any taxes imposed by or on behalf of Argentina or any political subdivision or taxing authority

thereof, except as required by applicable law. In the event that such withholdings or deductions are required by law, the Issuer will, subject to specified exemptions and limitations, pay such Additional Amounts (as defined under “Description of the Notes—Payments of Additional Amounts”) as are necessary to ensure that the holders receive the same amount as the holders would otherwise have received in respect of payments on the Notes in the absence of such withholdings or deductions. See “Description of the Notes—Payments of Additional Amounts.”

Optional Redemption ..... At any time prior to July 25, 2023, the Issuer may, at its option, redeem the Notes, in whole or in part, at a price equal to 100% of the principal amount and a “make-whole premium” plus accrued and unpaid interest, if any, to the date of redemption.

On and after July 25, 2023, the Issuer may, at its option, redeem the Notes, in whole or in part, at the redemption prices set forth in this offering memorandum, plus accrued and unpaid interest, if any, to the date of redemption.

At any time prior to July 25, 2023, the Issuer may, at its option, redeem up to 35% of the original principal amount of the Notes with the proceeds of certain equity offerings at a redemption price of 110% of the principal amount of the Notes, plus accrued and unpaid interest, if any, to the date of redemption.

The Issuer may, at its option, redeem the Notes, in whole but not in part, at a price equal to 100% of the principal amount, plus accrued and unpaid interest and any Additional Amounts upon the occurrence of specified tax events.

See “Description of the Notes—Redemption and Repurchase.”

Change of Control Offer ..... Upon the occurrence of a Change of Control Repurchase Event, the Issuer will make an offer to purchase all of the Notes at a purchase price in cash equal to 101% of the principal amount of the Notes, plus accrued and unpaid interest, if any, to the date of purchase. See “Description of the Notes—Redemption and Repurchase—Repurchase Offer upon a Change of Control Repurchase Event.”

Covenants..... The Indenture will, among other things, limit the Issuer’s ability and the ability of its Restricted Subsidiaries (as defined under “Description of the Notes”) to:

- incur additional indebtedness;
- pay dividends or make distributions or repurchase or redeem stock;
- make loans and investments;
- sell assets;
- incur or permit to exist certain Liens; and
- consolidate, amalgamate, merge or sell all or substantially all of our assets.

These covenants will be subject to a number of exceptions and qualifications. For more details, see “Description of the Notes—Certain Covenants.”

If, following the issue date, the Notes achieve Investment Grade ratings (as defined under “Description of the Notes”), certain covenants under the Indenture will cease to apply to the Notes. See “Description of the Notes—Certain Covenants—Suspension of Certain Covenants.”

Additional Notes ..... In the future, the Issuer may issue additional Notes, from time to time and without notice to or the consent of holders of the Notes, with the same terms and conditions in all respects as the Notes described herein (except for the issue date, the issue price and, if applicable, the first interest payment date); *provided* that, among other requirements, (i) no Default or Event of Default under the Indenture shall have occurred and then be continuing or shall occur as a result of such additional issuance, and (ii) such additional Notes rank *pari passu* and have equivalent terms and benefits as the Notes offered hereby; *provided further* that, if the additional Notes are not fungible with the Notes for U.S. federal income tax purposes, such additional Notes will have a separate CUSIP number, ISIN number or other identifying number from the Notes offered hereby. The Notes offered hereby and any additional Notes will be treated as a single class for all purposes under the Indenture and will vote together as one class on all matters with respect to the Notes.

Use of Proceeds ..... We intend to use the net proceeds from this offering in accordance with Section 36 of the Negotiable Obligations Law, (i) for working capital purposes in Argentina; (ii) to make investments in physical assets and tangible assets in Argentina; (iii) for payment of capital contributions in our subsidiaries, and for the acquisition of equity interests and/or providing financing to our subsidiaries in the ordinary course of business; and (iv) refinancing of indebtedness. Pending application, the proceeds may be invested in short-term investments. See “Use of Proceeds.”

Transfer Restrictions ..... We have not registered, and will not register, the Notes under the Securities Act, and the Notes may not be transferred except in compliance with the transfer restrictions set forth in “Transfer Restrictions.”

Form and Denomination of the Notes ..... The Notes will initially be issued in the form of one or more global notes without interest coupons, registered in the name of The Depository Trust Company (“DTC”) or its nominee. The Notes will be issued in minimum denominations of US\$1,000 and integral multiples of US\$1,000 in excess thereof. This offering will require a minimum subscription amount of US\$150,000.

Listing and Trading ..... The Notes are a new issue and there is no current trading market for the Notes. We will apply to have the Notes listed on the Luxembourg Stock Exchange and admitted for trading on the

Euro MTF of the Luxembourg Stock Exchange. We have also applied to have the Notes admitted for trading on the MAE. We cannot assure you that these applications will be accepted and that the Notes will be listed or remain so listed.

Clearance and Settlement .....	The Notes will be issued in book-entry form through the facilities of DTC for the accounts of its direct and indirect participants, including Euroclear Bank S.A. N.V., as the operator of the Euroclear System (“Euroclear”), and Clearstream Banking, société anonyme (“Clearstream”), and will trade in DTC’s same-day funds settlement system. Beneficial interests in Notes held in book-entry form will not be entitled to receive physical delivery of certificated Notes, except in certain limited circumstances. For a description of certain factors relating to clearance and settlement, see “Form of Notes, Clearing and Settlement.”
Governing Law .....	Law of the state of New York; <i>provided</i> that all matters relating to the due authorization, execution, issuance and delivery of the Notes by us, and matters relating to the legal requirements necessary in order for the Notes to qualify as <i>obligaciones negociables simples no convertibles en acciones</i> under Argentine law, will be governed by the Argentine Negotiable Obligations Law together with the Argentine Corporations Law and other applicable Argentine laws and regulations.
Jurisdiction .....	The Issuer will irrevocably submit to the non-exclusive jurisdiction of any state or federal court sitting in the Borough of Manhattan, City of New York, United States of America, and any Argentine court sitting in the City of Buenos Aires, Argentina. Notwithstanding the foregoing, in accordance with section 46 of the Argentine Capital Markets Law, holders of Notes may submit disputes regarding the Notes to the non-exclusive jurisdiction of the Arbitral Tribunal of the MAE or the ordinary courts for commercial matters.
Summary Executive Proceedings .....	Under the terms of Section 29 of the Negotiable Obligations Law, Notes constituting “ <i>obligaciones negociables simples no convertibles en acciones</i> ” grant their holders the right to institute summary executive proceedings to seek to obtain the payment of principal and interest amounts that are overdue under the Notes (including any additional amounts), which right may not be impaired or affected without such holder’s prior consent. In accordance with Section 129 of the Argentine Capital Markets Law, any beneficial owner who presents a certificate issued by the relevant depository in respect of the Notes represented by a global note may institute proceedings before any competent court in Argentina, including summary executive proceedings, to obtain any overdue amount under the Notes.
Initial Purchasers .....	Citigroup Global Markets Inc., HSBC Securities (USA) Inc. and Itau BBA USA Securities, Inc.

Trustee, Co-Registrar, Principal Paying Agent and Transfer Agent .....	The Bank of New York Mellon
Luxembourg Listing Agent .....	The Bank of New York Mellon SA/NV, Luxembourg Branch
Local Placement Agents .....	Banco Itaú Argentina S.A. and Itaú Valores S.A.
Registrar, Argentine Paying Agent, Transfer Agent and Representative of the Trustee in Argentina .....	Banco Santander Río S.A.
Risk Factors .....	Investing in the Notes involves significant risks and uncertainties. See “Risk Factors” and other information included in this offering memorandum for a discussion of factors you should carefully consider before deciding to purchase any Notes.

## RISK FACTORS

*Investing in the Notes involves significant risks. Prior to investing in the Notes, you should carefully consider the risks described below, in addition to the other information contained in this offering memorandum. We also may face additional risks and uncertainties that are not presently known to us, or that as of the date of this offering memorandum we deem immaterial, which may impair our business. If any of these events occur, the trading price of the Notes could decline, and we may not be able to pay all or part of the interest or principal on the Notes, and you may lose all or part of your investment.*

### **Risks Relating to Argentina**

#### ***Our business is largely dependent upon economic conditions in Argentina.***

All of our operations, properties and customers are located in Argentina, and, as a result, our business is to a large extent dependent upon economic conditions prevailing in Argentina. The changes in economic, political and regulatory conditions in Argentina and measures taken by the Argentine government have had and are expected to continue to have a significant impact on us. You should make your own assessment about Argentina and prevailing conditions in the country before taking an investment decision in the Notes.

The Argentine economy has experienced significant volatility in past decades, including numerous periods of low or negative growth and high and variable levels of inflation and currency devaluation. No assurances can be given that the Argentine economy will not suffer recession. If economic conditions in Argentina were to slow down, or contract, if inflation were to accelerate further, or if the Argentine government's measures to attract or retain foreign investment and international financing to incentivize domestic economic activity are unsuccessful, such developments could adversely affect Argentina's economic growth and in turn affect our financial condition and results of operations.

Argentina has confronted and continues to confront inflationary pressures. According to inflation data published by the INDEC, in 2018 the CPI and the wholesale price index increased by 47.6% and 73.5%, respectively and the three-year cumulative inflation rate has exceeded 100% causing Argentina to be now considered as a hyperinflationary economy under IFRS. See "Management's Discussion and Analysis of Financial Condition and Results of Operations—Principal Factors Affecting Our Results of Operations—Argentine Macroeconomic Conditions".

Additionally, during 2018 certain macroeconomic variables worsened and continue to face pressure during 2019, which in turn affected the economy. Among other variables, Argentina had high interest rates (the BADLAR – Buenos Aires Deposits of Large Amount Rate, published by the Central Bank, averaged 34.3% during 2018), the exchange rate between the Argentine peso and the U.S. dollar increased by 101% during the December 2017-December 2018 period, the gross domestic product ("GDP") growth rate during 2018 was negative 2.5%, and Argentina's country risk climbed to 793.90 points on December 31, 2018 from 232.50 on December 29, 2017.

Argentine economic conditions are dependent on a variety of factors, including, but not limited to, the following:

- domestic production, international demand and prices for Argentina's principal commodity exports;
- stability and competitiveness of the Argentine peso against foreign currencies;
- competitiveness and efficiency of domestic industries and services;
- level of consumption;
- foreign and domestic investment and financing;
- adverse external economic shocks;



- changes in official policies that may be adopted by the Argentine government;
- labor disputes and work stoppages, which may affect various sectors of the Argentine economy;
- public debt level and the difficulty of reducing the fiscal and trade deficits;
- the level of unemployment, which affects domestic consumption;
- political instability; and
- interest and inflation rates.

The political parties opposed to the current administration maintained the majority of seats in both chambers of the national congress in the last elections held in 2017, so the new administration needs to generate political consensus with the opposition to carry out their economic proposals. This situation generates more uncertainty regarding the ability of the Argentine government to get approval for new measures to be implemented.

The Argentine economy is also sensitive to political developments. Despite significant measures taken by the Argentine government that was elected on December 10, 2015, such as reforms to the INDEC, the elimination of exchange restrictions, the elimination or reduction of export taxes on certain products (although certain export tax restrictions were reinstated in September 2018), the adjustment of gas and electricity prices, tax reform and IMF financing, among others, Argentina's economy continues to face challenges. Inflation remains a challenge for Argentina given its high levels during 2018. If the measures adopted by the current administration are not able to resolve the structural inflationary disruptions of Argentina, the current inflationary levels could subsist and have a negative impact on the economic and financial conditions of Argentina, and as such affect our operations and financial condition.

On May 8, 2018, President Macri announced that the Argentine government would begin negotiations with the IMF with the goal of acquiring a stand-by line of credit that would grant Argentina access to IMF financing. On June 8, 2018, the key points of the agreement were made public, which consist of a three-year stand-by loan for US\$50 billion, subject to strict adjustments, mainly due to fiscal and political concerns, to which the Argentine government will be subject for the upcoming years. On June 22, 2018 the IMF made an initial disbursement of US\$15.0 billion. In addition, on September 26, 2018, Argentina published a new agreement with the IMF, which underpinned the original agreement. The revised agreement with the IMF was approved by the IMF's Executive Board on October 26, 2018. This new agreement supported the three-year stand-by agreement, approved on June 20, 2018 and includes an increase in available IMF funds of US\$19.0 billion through the end of 2019. It also raises the maximum loan amount available, to US\$57.1 billion through 2021. The funds available under the agreement will no longer be treated as preventive reserves, as the Argentine government has indicated that they intend to use IMF financing as budget support. The IMF-supported economic plan aims to strengthen the Argentine economy by focusing on four key pillars: (a) restore market confidence; (b) protect society's most vulnerable sectors; (c) strengthen the credibility of the Central Bank's inflation targeting framework; and (d) progressively lessen the strains on the balance of payments. There are no guarantees on the impact that the IMF loan will have on the Argentine economy or on the assets, economic and financial condition of Argentine companies.

Some of the commitments assumed by the Argentine government, as counterpart of the IMF loan, consist of: reduction of the primary fiscal deficit reaching a surplus in 2021, staggered reduction of inflation until 2021, greater power of the Central Bank to establish inflation targets three years in advance and a reduction of the stock of titles of the Central Bank proportionate to a level of capital that guarantees its financial autonomy, among others. The agreement includes a "social clause" according to which, in case the social situation worsens, the Argentine government can deviate from the objectives to reduce the fiscal deficit and increase social spending for the protection of the most vulnerable sectors.

On October 26, 2018, the IMF approved the extension of the stand-by agreement in an amount of approximately US\$5.6 billion. The IMF approved the first review of Argentina's performance under the new stand-by agreement and authorized a new transfer of approximately US\$5.7 billion. In turn, a new disbursement schedule

was established and the amounts to be disbursed for 2018 and 2019 were expanded. Under this new schedule, the expected disbursements through the end of 2018 were raised from US\$6 billion to US\$13.4 billion. On December 19, 2018, the IMF approved a new disbursement of US\$7.6 billion, which together with the previous two disbursements reached a total amount of US\$28.3 billion for the year 2018. In April 2019 there was a disbursement of US\$ 10.9 billion. In June 2019, the executive board of the IMF planned the following disbursements considering the fourth technical review of the Argentine economic condition. We cannot predict what measures will be adopted to comply with the agreements concluded with the IMF or their consequences on the Argentine economy, in general and if this could generate an adverse change in our financial condition and results of our operations.

On September 2018, the Central Bank established a new monetary policy with the aim of reducing the inflation rate. The Central Bank committed not to increase the monetary base (based on a monthly average) until June 2019, through its Monetary Aggregates Regime (*Agregados Monetarios*) as agreed in the 2018 IMF agreement, and defined the ranges for an intervention zone and a non-intervention zone applicable to the exchange rate through the end of 2018. In October 2018, the lower limit of the non-intervention zone was established at an exchange rate of Ps. 34 per US\$1.00 and the higher limit was set at Ps. 44 per US\$1.00, with a daily adjustment of 3% per month through the end of 2018. If the exchange rate rises above the maximum or falls below the minimum values of the area of intervention, the Central Bank will purchase or sell foreign currency in an amount of up to US\$75 to US\$150 million per day, respectively. Within the non-intervention zone, the exchange rate fluctuates freely. During the last quarter of 2018, the exchange rate has remained within the non-intervention zone, although approaching the lower limit. The Central Bank exceeded the monetary base target in all months since the launch of the new regime, while at the same time there has been sustained decline in interest rates.

On December 5, 2018, the Central Bank established that the limits of the non-intervention zone will be updated daily at a monthly rate of 2% between January 1 and March 31, 2019. On March 14, 2019, the Central Bank announced that the new limits of the non-intervention zone for the second quarter of 2019 will be updated daily at a monthly rate of 1.75%. Likewise, this new monetary policy scheme is consistent with the goals of the Ministry of Finance of achieving a primary fiscal balance in 2019, and a surplus in 2020. For its part, the Central Bank will not carry out further transfers to the Treasury, thus eliminating this source of monetary issuance and reinforcing the Central Bank's commitment to decreasing inflation over time. From January through May 2019, inflation remained at high levels, with the CPI increasing by 2.9%, 3.8%, 4.7%, 3.4% and 3.1%, respectively, on a month-to-month basis. In addition, as of July 5, 2019, the peso was valued at Ps. 41.98 per US\$1.00, an increase of approximately 11% compared to December 31, 2018.

If, despite the measures adopted by the Argentine government, these measures fail to address Argentina's structural inflationary imbalances, the current levels of inflation may continue or increase and have an adverse effect on Argentina's economy and, indirectly, on our business, financial condition and results of operations. Inflation can also lead to an increase in Argentina's debt and have an adverse effect on Argentina's ability to service its debt, mainly in the medium and long term when most inflation-indexed debt matures. In addition, weaker fiscal results could have a material adverse effect on the Argentine government's ability to access long term financing, which, in turn, could adversely affect Argentina's economy. Furthermore, considering the Argentine government's macroeconomic program, Argentina may not be able or willing to access international or domestic capital markets, and Argentina's ability to service its outstanding public debt could be adversely affected, and consequently adversely affect Argentina's economic and our financial condition and results of operations. See "Management's Discussion and Analysis of Financial Condition and Results of Operations—Principal Factors Affecting Our Results of Operations—Argentine Macroeconomic Conditions."

Argentina's economy is also vulnerable to adverse developments affecting its principal trading partners. A deterioration of economic conditions in Brazil, Argentina's main trading partner, and a deterioration of the economies of Argentina's other major trading partners, such as China or the United States, could have a material adverse impact on Argentina's balance of trade and adversely affect Argentina's economic growth and consequently, may adversely affect our financial health and results of operations. Furthermore, a significant devaluation of the currencies of our trading partners or trade competitors may adversely affect the competitiveness of Argentina and consequently adversely affect Argentina's economic and our financial health and results of operations.

A substantial increase in the value of the peso against the U.S. dollar would adversely affect Argentina's economic competitiveness. A significant real appreciation of the peso would adversely affect exports and increase the

trade deficit, which could have a negative effect on GDP growth and employments, as well as reduce the Argentine public sector's revenues by reducing tax collection in real terms, given its current heavy reliance on taxes on exports.

Additionally, as a consequence of the emergency measures which the Argentine government adopted during or after the 2001-2002 Argentine economic crisis, foreign shareholders of companies with operations in Argentina began arbitration proceedings against the Argentine government before the International Centre for Settlement of Investment Disputes ("ICSID") pursuant to the arbitration regulations of the United Nations Commission on International Trade Law ("UNCITRAL"). Outstanding claims against the Argentine government before ICSID under UNCITRAL regulations may entail new awards against the Argentine government, which in turn could have a substantially adverse effect on the Argentine government's ability to implement reforms and to foster economic growth. We cannot assure you that in the future the Argentine government will not breach its obligations. If the Argentine government were to default on its debt payment obligations, this would likely result in an impairment of economic activity, an increase in interest rates, additional pressure on the foreign exchange market and an increase in inflation rates, which in turn could adversely affect our operations and financial position. Likewise, if Argentina's access to international private financing or financing from multilateral organizations was restricted, or the inflows of foreign direct investments was limited, it is possible that Argentina will be unable to comply with its obligations and financing from multilateral financial entities may be limited or become unavailable. Additionally, a limitation on Argentina's ability to obtain financing in international markets may have, in the future, an adverse effect on our ability to access international credit markets at standard market rates in order to finance our operations.

***The result of the next presidential and provincial elections that will take place in 2019 could generate uncertainty in the Argentine economy and, consequently, in our businesses and the results of our operations.***

Argentina's national election for president and vice-president will take place in October 2019, and other relevant local and federal elections will also take place in 2019. The impact that the electoral process and its results could have on government policies and the economy of Argentina is uncertain. Additionally, we cannot predict the measures that may be adopted by the Macri administration or by any potential new administration at the national or provincial level, which could have a substantially adverse effect on the economy. In particular, we cannot assure you that current programs and policies related to the electricity sector will continue to be in place in the future.

***Certain risks are inherent in any investment in a company operating in an emerging market such as Argentina.***

According to an MSCI (Morgan Stanley Capital International) release, since May 2019 Argentina is considered an "emerging market". Investing in emerging markets generally carries risks. These risks include political, social and economic instability that may affect Argentina's economic results which can stem from many factors, including the following:

- high interest rates;
- abrupt changes in currency values;
- high levels of inflation;
- exchange and capital controls;
- wage and price controls;
- regulations to import equipment and other necessities relevant for operations;
- changes in governmental economic or tax policies; and
- political and social tensions.

In particular, we continue to actively manage our schedule of work, contracting, procurement and supply-chain activities to effectively manage costs. However, price levels for capital and operating expenses associated with

the generation of electric power can be subject to external factors beyond our control including, among other things, the general level of inflation, fuel prices and prices charged by the industry's material and service providers, which can be affected by the volatility of the industry's own supply and demand for such materials and services.

Any of these factors, as well as volatility in the capital and foreign exchange markets, may adversely affect our financial condition and results of operations or the liquidity and the trading price of the Notes.

***Failure to adequately address actual and perceived risks of institutional deterioration and corruption may adversely affect Argentina's economy and financial condition.***

A lack of a solid and transparent institutional framework for contracts with the Argentine government and its agencies and corruption allegations have affected and continue to affect Argentina. Argentina ranked 85 of 180 in Transparency International's 2018 Corruption Perceptions Index and 117 of 190 in the World Bank's Doing Business 2018 report.

As of the date of this offering memorandum, there are various ongoing investigations into allegations of money laundering and corruption being conducted by the Office of the Argentine Federal Prosecutor, including the largest such investigation known as Los Cuadernos de las Coimas (the "Notebooks Investigation"), which have negatively impacted the Argentine economy and political environment. Depending on how long it takes to conclude these investigations and their results, companies involved in the investigations may be subject to, among other consequences, a decrease in their credit ratings and claims filed by their investors, and may further experience restrictions in their access to financing through the capital markets, together with a decrease in their income. Additionally, as the criminal cases against the directors, managers and shareholders of these companies involved in the investigations move forward, these companies may be restricted from rendering services, fines, total or partial suspension of business activities, suspension from participating in public bids or tenders for the execution of public works or services, dissolution and winding up of the legal entity under certain circumstances, and loss or suspension of government benefits, among others. These adverse effects could restrict these companies' ability to conduct their operating activities and to meet their financial obligations. As a consequence of the above, the number of suppliers available for our operations may be reduced and, as such, have an adverse effect on our commercial activities and results of operations.

Recognizing that the failure to address these issues could increase the risk of political instability, distort decision-making processes and adversely affect Argentina's international reputation and ability to attract foreign investment, the Argentine government has announced several measures aimed at strengthening Argentina's institutions and reducing corruption. These measures include the reduction of criminal sentences in exchange for cooperation with the government in corruption investigations, increased access to public information, the seizing of assets from corrupt officials, increasing the powers of the Anti-corruption Office (*Oficina Anticorrupción*) submitting a project for a new public ethics law, among others. The Argentine government's ability to implement these initiatives is uncertain as it would be subject to independent review by the judicial branch, as well as legislative support from opposition parties.

As part of those initiatives, the Argentine government enacted the Corporate Criminal Liability Law. Under such law, a company may be held liable if any of its employees, directors, officers, partners, agents or other related individuals have committed or commit a corruption related offence (such as bribery of a public official, among others) either directly or indirectly, with the intervention, in the name or interest or for the benefit of the company. If any employee, director, officer, partner, agent or other related individual has committed or commits any such corruption related offenses that results in an improper benefit for us or any shareholder, we or the shareholder, as applicable, could be liable under the Corporate Criminal Liability Law for committing such crime and may be subject to various sanctions and the forfeiture of assets obtained through the relevant illegal actions.

However, we cannot give any assurance that the implementation of these measures or other new measures by the Argentine government will be successful in rejecting institutional deterioration and preventing corruption, or on the effect that the Notebooks Investigation may have on the Argentine economy.

***The Argentine economy has been adversely affected by economic developments in other markets.***

Financial and securities markets in Argentina, and also the Argentine economy, are influenced by economic and market conditions in other markets worldwide, including those relating to a potential trade war between China and the United States. Although economic conditions vary from country to country, investors' reactions to events occurring in one country sometimes demonstrate a "contagion" effect in which an entire region or class of investment is disfavored by international investors.

Consequently, there can be no assurance that the Argentine financial system and securities markets will not continue to be adversely affected by events in developed countries' economies or events in other emerging markets, which could in turn, adversely affect the Argentine economy and, indirectly, our business, financial condition and results of operations, and the market value of our Notes.

***The implementation of new export duties, other taxes and import regulations could adversely affect our results.***

Decree No. 793/2018, which became effective in September 2018, established an export duty of 12% on the export for consumption of all merchandise included in tariff positions of the Common Mercosur Nomenclature through December 31, 2020. This export duty may not exceed four pesos per U.S. dollar of the taxable value or the official free on board price, as applicable. For merchandise which does not constitute primary sector products, the duty may not exceed three pesos per U.S. dollar of the taxable value or the official free on board price, as applicable. These duties may cause Argentine exports to be less competitive, and this may have an adverse effect on the Argentine economy.

We cannot assure you that taxes and import/export regulations of this nature will not be modified in the future or that other new taxes or import/export regulations will not be imposed.

***We may be exposed to fluctuations in foreign exchange rates.***

Our results of operations are exposed to currency fluctuations, and any devaluation of the peso against the U.S. dollar and other hard currencies may adversely affect our business and results of operations. The value of the peso has fluctuated significantly in the past, such as in January 2014 when the Argentine peso declined approximately 23% against the U.S. dollar and in December 2015 when the value of Argentine peso decreased approximately 40% against the U.S. dollar. In September 2018 the value of the Argentine peso fell to Ps. 40.90 per US\$1.00, which represented an increase in the exchange rate between the Argentine peso and the U.S. dollar of 118% during the period. As of December 31, 2018, the value of the Argentine peso amounted to Ps. 37.81 per US\$1.00 which represented an increase in the exchange rate between the Argentine peso and the U.S. dollar of 101% during the period. As of July 5, 2019, the peso was valued at Ps. 41.98 per US\$1.00, a decrease of approximately 11% against the U.S. dollar, compared to December 31, 2018.

The main effects of the devaluation of the Argentine peso on our net profit are related to (i) deferred income tax related mainly to fixed assets, which we expect would have a negative effect; (ii) current income tax, (iii) increased depreciation and amortization resulting from the remeasurement in pesos of our fixed and intangible assets; and (iv) exchange rate differences as a result of our exposure to the peso, which we expect would have a positive effect due to the fact that our functional currency is the U.S. dollar. In addition, regarding our financial position, the majority of our debt is denominated in currencies other than the peso; consequently, a devaluation of the peso against such currencies will increase the amount of pesos we need to comply with in the terms of loans. For more information on the value of the Argentine peso, see "Exchange Rates and Exchange Controls".

We are unable to predict whether, and to what extent, the value of the peso may further depreciate or appreciate against the U.S. dollar and how any such fluctuations could affect our business.

***We could be subject to exchange and capital controls.***

In the past, in an attempt to prevent capital flight and depreciation of the Argentine peso, Argentina imposed exchange controls and transfer restrictions substantially limiting the ability of companies to retain foreign currency or

make payments abroad. Beginning in 2011, additional foreign exchange controls have been imposed that restrict or limit purchases of foreign currency and transfers of foreign currency abroad.

In December 2015, the Macri administration eliminated certain exchange controls imposed by the previous administration, such as (i) the requirement that foreign currency be deposited and exchanged in Argentina in respect of finance transactions outside Argentina, and (ii) the requirement that 30% of funds in U.S. dollars held in Argentina be frozen pursuant to Decree No. 616/2005. Additionally, through Central Bank Communication “A” 6244, the Central Bank derogated the regulations relating to restrictions on exchange rate transactions, settlement of foreign exchange transactions, and the provisions of Decree No. 616/2005, except for those regulations relating to information regimes, surveys or similar informational matters relating to foreign exchange transactions.

There can be no assurance that future regulatory changes related to exchange and capital controls will not adversely affect our financial condition or results of operations, our ability to meet our obligations denominated in foreign currency or our ability to execute our financing and capital expenditure plans.

***Our access to international capital markets is influenced by the perception of risk in Argentina and other emerging economies.***

Economic and market conditions in Argentina and in other emerging market countries, especially those in Latin America, influence the market for securities issued by Argentine companies. Volatility in securities markets in Latin America and in other emerging market countries may have a negative impact on the trading price of our Notes and on our ability and the terms on which we are able to access international capital markets. We cannot assure that the perception of risk in Argentina and other emerging markets may not have a material adverse effect on our ability to raise capital, including our ability to refinance our debt at maturity, which would negatively affect our investments plans and consequently our financial condition and results of operations, and also have a negatively impact on the trading price of our Notes. We can give no assurance as to potential adverse impact of the factors discussed above on our financial condition and/or results of operations.

#### **Risks Relating to the Electric Power Sector in Argentina**

***The Argentine government has intervened in the electric power sector in the past, and is likely to continue intervening.***

Historically, the Argentine government has played an active role in the electric power industry through the ownership and management of state-owned companies engaged in the generation, transmission and distribution of electric power. Since 1992 and the privatization of several state-owned companies, the Argentine government has reduced its control over the industry. However, as is the case in most other countries, the Argentine electric power industry remains subject to strict regulation and government intervention. Moreover, to address the Argentine economic crisis of 2001 and 2002, the Argentine government adopted Law No. 25,561 (the “Public Emergency Law”) and other regulations, which made a number of material changes to the regulatory framework applicable to the electric power sector. These changes have had significant adverse effects on electric power generation, distribution and transmission companies and included the freezing of distribution margins, the revocation of adjustment and inflation indexation mechanisms for tariffs, a limitation on the ability of electric power distribution companies to pass on to the consumer increases in costs due to regulatory charges and the introduction of a new price-setting mechanism in the WEM, all of which had a significant impact on electric power generators and caused substantial price differences within the market.

From 2007 to 2015, the Argentine government continued to intervene in the electric power industry by, for example, granting temporary margin increases, proposing a new tariff regime for residents of poverty-stricken areas, increasing remunerations earned by generators for capacity, operation and maintenance services, creating specific charges to raise funds that are transferred to government-managed trust funds that finance investments in generation and distribution infrastructure and mandating investments for the construction of new generation plants and the expansion of existing transmission and distribution networks.

For example, in March 2013, Resolution No. 95/2013, issued by the former Secretary of Energy, suspended the renewal of sales contracts in the term market and execution of new agreements in the WEM, and ordered that any demand not satisfied by Argentine generators must be directly supplied by CAMMESA. As a result, Argentine generators are required to supply capacity and energy to CAMMESA at prices fixed by the former Secretary of Energy.

Since December 2015, the Argentine government has initiated successive reforms to the Argentine electric power industry. On December 16, 2015, the Argentine government declared a state of emergency with respect to the national electric power system that remained in effect until December 31, 2017. The state of emergency allowed the Argentine government to take actions designed to guarantee the supply of electric power in Argentina, such as instructing the former MEyM to elaborate and implement, with the cooperation of all federal public entities, a coordinated program to guarantee the quality and security of the electric power system and rationalize public entities' consumption of energy. In addition, the Argentine government and certain provincial governments have approved significant price adjustments and tariff increases applicable to certain generation and distribution companies. Following the tariff increases, preliminary injunctions suspending such increases were requested by customer associations and non-governmental organizations that defend customer rights, which preliminary injunctions were granted by Argentine courts.

Since 2016, the Argentine government has also established public bidding processes for the development of new generation projects from both thermal and renewable sources. These measures aim not only to satisfy domestic electric power demand, but also to promote investments in the electric power sector and improve the economic situation of the WEM, which, as discussed above, has faced challenges since 2001.

In March 2016, the former Secretary of Electric Energy enacted Resolution No. 22/16, through which it adjusted the electric power prices for the sale of energy by generation companies under Energía Base. The Secretary of Electric Energy cited the fact that WEM prices have been distorted and discouraged private sector investment in power generation and that it was necessary to raise tariffs to partially compensate for increasing operation and maintenance costs and to improve the cash flow generation capacity of these companies. Additionally, on February 7, 2017 the Secretary of Electric Energy enacted Resolution No. 19/17 which amended Resolution No. 22/16 and established a new tariff scheme for the existing generators through certain incentives to increase the availability of the energy not committed to Energía Plus contracts. Prices under Energía Base were established in U.S. dollars but payable in Argentine pesos at the exchange rate published by the Central Bank "*Tipo de Cambio de Referencia Comunicación 'A' 3500 (Mayorista)*" as of the last business day of the month of the relevant Economic Operation Document (*Documento de Transacción Económica, "DTE"*), upon which the relevant commercial documentation shall be issued.

On February 28, 2019, by means of Resolution No. 1/2019, the Secretary of Renewable Resources and Electric Market further amended the remuneration under Energía Base. Such regulation adjusted the fixed payment for availability of thermal generators based on the periods of peak demand (summer and winter); and set a further adjustment based on the availability and the energy dispatched by each unit. These changes had a negative effect on the overall compensation received by our thermal generators. This regulation is transitory and will be in effect until final market regulations are established, which, as of the date of this offering memorandum, has not yet occurred. For more information on Resolution No. 1/2019, see "Business—Our Remuneration—Energía Base."

We cannot guarantee whether further changes to the electric power sector will be enacted or the impact of those changes. It is possible that certain measures may be adopted by the Argentine government that could have a material adverse effect on our business and results of operations, or that the Argentine government may adopt emergency legislation similar to the Public Emergency Law or other similar resolutions in the future that could have a direct impact on the regulatory framework of the electric power industry and indirectly adversely affect the electric power generation industry, and therefore, our business, financial condition and results of operations.

***Electricity generators, distributors and transmitters have been materially and adversely affected by emergency measures adopted in response to Argentina's economic crisis of 2001 and 2002, many of which remain in effect.***

Since the Argentine economic crisis of 2001 and 2002, Argentina's electric power sector has been characterized by government regulations and policies that have resulted in significant distortions in the electric power market and its legal framework, particularly with respect to prices, throughout the whole value chain of the sector (generation, transmission and distribution). Historically, Argentine electric power prices were calculated in U.S.

dollars and margins were adjusted periodically to reflect variations in relation to costs. In January 2002, the Public Emergency Law authorized the Argentine government to renegotiate its public utility contracts. Under this law, the Argentine government revoked provisions in the public utility contracts related to the adjustment and inflation indexation mechanism. Moreover, the tariffs on such contracts were frozen and converted from their original U.S. dollar values to Argentine pesos at a rate of Ps.1.00 per US\$1.00. For further information on the changes to the legal framework of the Argentine electric power industry caused by the Public Emergency Law, see “The Argentine Electric Power Sector.”

These measures, coupled with the effect of high inflation and the devaluation of the peso in recent years, led to a significant decline in revenues and a significant increase of costs in real terms, which could no longer be recovered through margin adjustments or market price-setting mechanisms. This situation, in turn, led many public utility companies to suspend payments on their financial debt (which continued to be denominated in U.S. dollars despite the pesification of revenues), effectively preventing these companies from obtaining further financing in the domestic or international credit markets and making additional investments.

At the end of 2015, after declaring a state of emergency with respect to the national electrical system, which lasted until December 31, 2017, the Argentine government increased electric power tariffs in the WEM under Energía Base. Subsequently, preliminary injunctions suspending such increases were requested by customer associations and non-governmental organizations that advocate for customer rights. On May 31, 2018, the Argentine Congress passed Law No. 27,443, by means of which a state of tariff emergency was declared until December 31, 2019, and the tariffs were set back to the tariff charts in force in November 2017, establishing that future increases shall not exceed the salary index variation for residential users and the wholesale price index for small and medium-sized enterprises. Immediately after its enactment, on June 1, 2018, by means of Decree No. 499/2018, President Macri exercised his constitutional veto power; therefore, such law did not come into effect.

We do not control the measures taken by the Argentine government, nor can we assure you that such measures and/or regulatory amendments, or any future measures, and/or regulatory amendments, will be sufficient to address the structural problems created by the economic crisis of 2001 and 2002 and its aftermath. We cannot assure you that such measures will be effectively implemented or that preliminary injunctions will not suspend or block their enforcement. In addition, we cannot assure you that the current Argentine government, or any future Argentine government, will not adopt emergency measures similar to the Public Emergency Law, or other similar regulations which negatively affect our business and results of operations. For further information, see “The Argentine Electric Power Sector.”

***CAMMESA, and other customers in the electric power sector, may alter and/or delay payments to electric power generators.***

CAMMESA is our main customer and we receive compensation from CAMMESA pursuant to Energía Base and our PPAs with CAMMESA. Payments by CAMMESA to us depend upon payments that CAMMESA in turn receives from other WEM agents such as electric power distributors as well as the Argentine government.

Since 2012, certain WEM agents defaulted on their payments to CAMMESA, which adversely affected CAMMESA’s ability to meet its payment obligations to electric power generators. As an example, CAMMESA is required to make payment to generators under Energía Base within 42 days as from the end of the relevant month. Notwithstanding, due to delays in payments that CAMMESA received from other WEM agents as a consequence of the freezing of the tariff, certain payments made under Energía Base were delayed, with payments from CAMMESA made within approximately 60 days of month-end, rather than the required 42 days after the date of billing.

In accordance with the applicable law, CAMMESA is required to pay interest to the generators for such payment delays. We cannot assure you that CAMMESA will be in a position to pay the generators both, for the energy dispatched and for the generation capacity made available, in a timely basis or in full. In the past, when CAMMESA lacked sufficient funds to pay the generators, a significant portion of such unpaid balances were converted into LVFVD. Such practice may be implemented in the future. The inability of CAMMESA to make payments to generators could adversely affect our business, results of operations and financial condition.



In addition, the rates under our remuneration under our PPAs with CMMESA and Energía Base are denominated in U.S. dollars and payable in Argentine pesos. Although pursuant to the PPAs and Energía Base, CMMESA covers any exchange rate fluctuation effects during the first 41 days after the billing date by making payments based on the reference exchange rate on the billing date, such exchange rate fluctuations may have a negative effect on our results to the extent there is devaluation of the peso during the period between the 42nd day after the billing date and the actual payment date, which effect may be increased if there are payment delays. Our results of operations have been affected and will continue to be affected by the fluctuation of the U.S. dollar/Argentine peso exchange rate.

We have also entered into certain PPAs with YPF and private large user clients for the sale of energy. We cannot assure you that YPF or private sector clients will comply with their payment obligations under the PPAs in a timely basis, which could adversely affect our business, results of operations and financial condition.

***Electricity demand may be affected by tariff increases, which could lead generation companies like us to record lower revenues.***

During the 2001 and 2002 economic crisis, electric power demand in Argentina decreased due to the decline in the overall level of economic activity and the deterioration in the ability of many consumers to pay their electric power bills. In the years following the 2001 and 2002 economic crisis, electric power demand experienced significant growth, increasing at an estimated average of approximately 3.1% per annum from 2002 through 2015 (despite a decline in 2009), due to its reduced cost as a result of certain energy subsidies, freezing of margins and tariffs, and elimination of inflation adjustment provisions in distribution concessions. In March 2016, the Argentine government unified and increased wholesale energy prices for all consumption in Argentina, eliminated certain energy subsidies and implemented an incentive plan (through discounts) for residential customers whose electric power consumption is at least 10% lower than their consumption for the same month of the previous year. Such tariff increase had a negative impact on the overall consumption. In addition, the current recession has also caused a decrease in demand, especially among industrial consumers.

Any significant increase in energy prices to consumers (whether through a tariff increase or through a cut in consumer subsidies) or a further decline of economic activity could result in a decline in demand for the energy that we generate. Any material adverse effect on electric power demand, in turn, could lead electric power generation companies, like us, to record lower revenues and results of operations, affecting negatively our capacity to honor our payment obligations.

***Argentina has certain energy transmission limitations that adversely affect the capacity of electric power generators to deliver all of the energy they are able to produce, which results in reduced sales.***

The energy that generators dispatch to the transmission system for delivery to the distribution system at all times depends on the capacity and effectiveness of the transmission system. At certain times of the year, or in certain operational conditions, the transmission system restricts the capacity of generators to deliver available energy. As a result, the amount of energy generated is larger than what the transmission and distribution systems are capable of transmitting or distributing. Any transmission or distribution limitation for generators could reduce the energy sold, which could adversely affect our business, results of operations and financial condition.

Additionally, due to restrictive transmission and distribution price regulation, transmission and distribution companies have not had sufficient incentive to invest in expansion of transmission and distribution infrastructure. We cannot predict whether transmission and distribution facilities will be expanded or updated in the country generally, or in the specific markets where we operate or seek to operate, to accommodate competitive access to those markets. If the demand for energy continues to increase in the future, the current levels of power transmission and distribution or the installed technology may not be sufficient to meet the demand and may cause disruptions. For example, a malfunction of certain transmission lines of the SADI recently caused a blackout throughout the country on June 16, 2019. A sustained increase in disruptions in the electrical system could generate future shortages and could prevent us from delivering the electricity we produce and sell, which, in turn, could adversely affect our business, results of operations and financial condition.

Due to such restrictions in the transmission lines, Resolution No. 281/2017 was enacted setting forth a competitive procedure between generators to determine priority in the dispatch of renewable energy projects destined for the MATER. Currently, our Manantiales Behr wind farm and our Los Teros I and Los Teros II projects have a priority of dispatch of 99 MW and 173 MW, respectively. However, we cannot assure you that our new renewable energy projects whose energy we intend to sell in the MATER will obtain this priority -in full or in part- or whether our operating renewable assets will maintain such priority. If such priority is not obtained or maintained, such lack of priority could adversely affect the operations of such projects and adversely affect our results of operations and financial condition.

***Our ability to generate electricity at our thermal generation plants partially depends on the availability of natural gas and, to a lesser extent, diesel fuel, and fluctuations in the supply or price of natural gas and diesel fuel could materially adversely affect our results of operations.***

The supply and price of natural gas and diesel fuel used in our thermal generation plants has been and may from time to time continue to be affected by, among other things, the availability of natural gas and diesel fuel in Argentina. Until recently, Argentina imported a large amount of natural gas and diesel fuel at a higher price than the price applicable to domestic supply as a result of low domestic production. In addition, many oil and gas fields in Argentina are mature and we cannot assure you that reserves will not be depleted in the medium or short terms. Moreover, investments in the gas transmission infrastructure have been limited so we cannot assure that there will be transmission capacity enough to transport natural gas to our power plants.

Under Energía Base, CAMMESA provides us with the required fuel. Under our PPAs with CAMMESA for our thermal power plants we have the option to choose CAMMESA to provide us with natural gas or diesel fuel, or to reimburse us for the cost of fuel. Under our PPAs with YPF for Loma Campana I, Loma Campana Este, and CT Manantiales Behr, YPF is obligated to provide us with the necessary natural gas or diesel fuel to operate the thermal power plants. If CAMMESA or YPF stops providing us with either natural gas or diesel fuel and we are unable to purchase natural gas and diesel fuel at prices that are favorable to us or fully reimbursable by CAMMESA or YPF, or if the supply of natural gas or diesel fuel is reduced, our costs could increase or our ability to profitably operate our thermal generation facilities could be impaired. Such a disruption to our thermal generation business would, in turn, have a material adverse effect on our activity, financial condition, results of operations, and ability to pay our debts.

***Our ability to operate our wind farms in a profitable manner depends, to a larger extent, on adequate wind and other climatic conditions.***

The amount of energy generated by, and the profitability of, wind farms are highly dependent on climate conditions, particularly wind conditions, which can vary materially across locations, seasons and years. Variations in wind conditions at wind farm sites occur because of daily, monthly and seasonal fluctuations in wind currents and, over the longer term, as a result of more general climate changes and shifts. Turbines operate when wind speeds fall within certain specific ranges that vary by turbine type and manufacturer so, if wind speeds fall outside these ranges, energy output at our wind farms would decline.

During the development phase and prior to the construction of any wind farm, a wind study to evaluate the potential wind resource of the site is typically conducted over a period of several years. These wind studies have been conducted by third parties and independent technical consultants with respect to the estimated load factor resulting from our wind studies and the model of turbines to be used. We base our core assumptions and investment decisions on the findings of these studies. We cannot assure you that observed climate conditions at a project site will conform to the assumptions that were made during the project development phase on the basis of these studies, and, therefore, we cannot assure that our wind farm or wind farm projects under construction will be able to meet their anticipated production levels. It is possible that future wind patterns and electricity production at our wind farms will not reflect the historical wind patterns at the respective sites or the projections, and wind patterns at each site will change over time.

Since our revenues under our PPAs related to renewable energy depend on the amount of energy dispatched, if wind resources in the areas where our wind farms are located are lower than expected, our electricity generation at such wind farms would be lower than expected, which would adversely affect our results of operations and financial condition and, in certain cases, expose us to potential penalties under relevant PPAs with private clients.

***We may face competition.***

The power generation markets in which we operate are characterized by numerous strong and capable participants, many of which may have extensive and diversified developmental or operating experience (including both domestic and international) and financial resources similar to or significantly greater than ours. See “Business—Competition.” In addition, our competitors may consolidate or merge their operations which could result in larger players with better financial and operational resources. An increase in competition could cause reductions in prices and increase acquisition prices for fuel, raw materials and existing assets and, therefore, adversely affect our results of operations and financial condition.

We compete with other generation companies for the capacity that are allocated through bidding processes. Because of the competition among generation companies in these auction processes, we cannot predict whether we will be awarded the projects and whether we will be able to utilize these assets as intended.

We and our competitors are connected to the same electrical grid that has limited capacity for transportation, which, under certain circumstances, may reach its capacity limits. Therefore, new generators may connect or existing generators may increase their outputs and dispatch more electric power to the same grid that would prevent us from delivering our energy to our customers. In addition, the Argentine government (or any other entity on its behalf) might not make the necessary investments to increase the system’s capacity, which, in the event there is an increase of energy output, would allow us and existing and new generators to efficiently dispatch our energy to the grid and to our customers. In addition, the regulators may establish dispatch priorities to address such limitations that may not be favorable to us. As a result, an increase in competition coupled with transmission restrictions could affect our ability to deliver our product to our customers, which would adversely affect our business, results of operations and financial condition.

***We operate in a heavily regulated sector that imposes significant costs on our business, and we could be subject to fines and liabilities that could have a material adverse effect on our results of operations.***

We are subject to a wide range of federal, provincial and municipal regulations and supervision, including laws and regulations pertaining to tariffs, labor, social security, public health, consumer protection, the environment and competition. Furthermore, Argentina has 23 provinces and one autonomous city (the City of Buenos Aires), each of which, under the Argentine National Constitution, has the power to enact legislation concerning taxes, environmental matters and the use of public space. Within each province, municipal governments can also have powers to regulate such matters. Although the generation of electric power is considered an activity of general interest (*actividad de interés general*) subject to federal legislation, due to the fact that our facilities are located throughout various provinces, we are also subject to provincial and municipal legislation. Future developments in the provinces and municipalities concerning taxes (including sales, security and health and general services taxes), environmental matters, the use of public space or other matters could have a material adverse effect on our business, results of operations and financial condition. Compliance with existing or future legislation and regulations could require us to make material expenditures and divert funds away from planned investments in a manner that could have a material adverse effect on our business, results of operations and financial condition.

In addition, our failure to comply with existing regulations and legislation, or reinterpretations of existing regulations and new legislation or regulations, such as those relating to fuel and other storage facilities, volatile materials, cyber security, emissions or air quality, hazardous and solid waste transportation and disposal and other environmental matters, or changes in the nature of the energy regulatory process may subject us to fines and penalties and have a significant adverse impact on our financial results.

***The demand for electricity is seasonal, mainly due to climatic factors.***

Energy demand fluctuates according to the season and climate conditions may materially and adversely impact energy demand. During the summer (December through March), energy demand may increase significantly due to the need for air conditioning and, during the winter (June through August), energy demand may fluctuate according to the needs for lighting and heating. Although our revenues mainly derive from fixed payments for availability, pursuant to the terms of our PPAs and Energía Base, a portion of our revenues from our thermal assets derive from the sale of energy. In addition, our sales from our wind farm and our wind projects are (or will be)

remunerated based on the energy we dispatch. As a result, seasonal changes could materially and adversely affect the demand for energy and, consequently, affect our results of operations and financial condition.

***Risks arise for our business from technological change in the energy market.***

The energy market is subject to far-reaching technological change, both on the generation side and on the demand side. For example, with respect to energy generation, these new technologies include, among others, the development of energy storage devices (battery storage in the megawatt range) or facilities for the temporary storage of power through conversion to gas (so-called “power-to-gas-technology”), the increase in energy supply due to new technological applications such as fracking or the digitalization of generation and distribution networks.

New technologies to increase energy efficiency and improve heat insulation, for the direct generation of power at the consumer level, or that improve refeeding (for example, by using power storage for renewable generation) may, on the demand side, lead to structural market changes in favor of energy sources with low or zero carbon dioxide emissions or in favor of decentralized power generation (for instance, via small-scale power plants within or close to residential areas or industrial facilities).

If we are unable to react to changes caused by new technological developments and the associated changes in market structure, our results of operations, financial position, or business, could be materially and adversely affected.

***We may be subject to expropriation, nationalization or similar risks.***

All of our assets are located in Argentina. We are engaged in the business of power generation and, as such, our business or our assets may be considered by the government to be a public service or essential for the provision of a public service. Therefore, our business is subject to political uncertainties, including expropriation or nationalization of our business or assets, loss of concessions, renegotiation or annulment of existing contracts, and other similar risks.

In such an event, we may be entitled to receive compensation for the expropriation, nationalization or regulatory taking of all or part of our assets. However, the price received may not be the market price or sufficient to repay our liabilities, or we may need to take legal actions to claim appropriate compensation or to receive such compensation. If all our assets are expropriated or nationalized, the compensation may not be sufficient to repay the Notes. If part of our assets are expropriated or nationalized, our business, as currently conducted, our financial condition or results of our operations could be adversely affected.

***Climate change regulations and restrictions on greenhouse gas emissions may negatively affect the results of our operations.***

Our business focuses on thermal power generation (in addition to renewable energy), which is largely associated with greenhouse gas emissions. In 2015, the G7 countries agreed to the goal of the substantially complete decarbonization of the world economy by the end of the 21<sup>st</sup> century. Decarbonization is the transition of energy economics towards a lower carbon uptake. According to the targets set at the World Climate Conference in Paris, France, which took place at the end of 2015, greenhouse gas emissions should be reduced globally by 40-70% by 2050, compared to 2010 levels. In particular, this requires a transition from fossil energy sources to renewable energy sources.

Should the decarbonization of the energy industry be implemented or be implemented earlier than expected, or if we fail to adapt our business activities to such new policies in time and to a sufficient degree, our business, financial condition and results of operations could be adversely affected.

## **Risks Relating to the Company**

***Our results depend to a large extent on the compensation established by the Secretary of Electric Energy and received from CAMMESA.***

Our compensation depends to a large extent on compensation determined by the availability of our power plants and the dispatch of generated electricity. For the year ended December 31, 2018, and for the three-month period ended March 31, 2019, 82.5% and 73.5% of our revenues, respectively, derived from Energía Base and our PPAs with CAMMESA, respectively. The remuneration we receive under Energía Base is determined by the Secretary of Electric Energy and such determinations are not based on objective parameters. In addition, our PPAs with CAMMESA set our remuneration but we cannot give you assurances that those PPAs will be renewed upon expiration. Since these tariffs are not tied to the generation cost or the generator's cost structure, these tariffs may not fully offset the costs or provide an adequate margin of the generators. Recently, Resolution No. 1/2019 introduced modifications to the remuneration under Energía Base, which resulted in lower tariffs paid to generations.

As a result, a substantial portion of our revenues are highly dependent on actions taken by regulatory authorities. Any further change in the current system could have a material adverse effect on our revenues, our results of operations.

***We may be subject to significant penalties or record lower revenues in case of non-compliance with our PPAs.***

In accordance with our PPAs with CAMMESA and YPF and other private clients for thermal power plants and Energía Base, we collect a fixed availability payment which derives from the actual availability of our power plants. If the availability of any or all of our thermal power plants falls below certain thresholds, we may be subject to penalties.

In addition, under our PPAs for our projects under construction, we assumed the obligation to commence commercial operations on certain dates. Recently, due to factors beyond our control, certain equipment needed for the construction of our El Bracho ST was lost in route to Argentina. As a result, the construction of such generating unit may be completed after the date set forth in the applicable PPA. Although we requested CAMMESA and the SGE to provide an extension for such term, if such extension is not granted, we may be fined pursuant to the terms of the PPA. For more information, see "Business—Our Projects—Thermal Energy—El Bracho ST." Failure to complete the El Bracho ST project or any other projects could result in the imposition of significant penalties and the execution of the performance bonds delivered to guarantee compliance with such dates. See "—We may experience difficulties obtaining the performance bonds that we require in the normal course of our operations or may face challenges in meeting potential reimbursement obligations arising therefrom." We cannot assure you that we will be able to comply in full with all our PPAs, which could result in a material adverse effect on our business and results of operations.

***Circumstances beyond our control may prevent us from achieving, or delay, the commercial operation of our projects under construction.***

We have significant expansion projects under construction, for closed cycle, cogeneration and wind farms, which, once completed, will significantly increase our installed generation capacity. In addition, we have participated and we will continue participating in bidding processes for both renewable and thermal energy sources announced by the Argentine government and the private sector. However, we cannot assure you that our bids will be successful or that we will be able to enter into new PPAs in the future.

Delays in construction or commencement of operations of our expansion projects could lead to an increase in our financial needs and also cause our financial returns on new investments to be lower than expected, which could materially and adversely affect our financial condition. Factors that may impact our ability to build, or commence operations at, our existing or new plants include: (i) the failure of contractors to complete or commission the facilities or auxiliary facilities by the agreed upon date or within budget; (ii) the unexpected delays of third parties in providing or agreeing to project milestones in the construction or development of necessary infrastructure linked to our generation business; (iii) the delays or failure by our turbine suppliers in providing fully operational turbines in a timely manner; (iv) difficulty or delays in obtaining the necessary financing in terms satisfactory to us or at all; (v)

delays in obtaining regulatory approvals, including environmental permits; (vi) court rulings against governmental approvals already granted, such as environmental permits; (vii) shortages or increases in the price of equipment reflected through change orders, materials or labor; (viii) opposition by local and/or international political, environmental and ethnic groups; (ix) strikes; (x) adverse changes in the political and regulatory environment in Argentina; (xi) unforeseen engineering, environmental and geological problems; and (xii) natural disasters and severe weather conditions (including lightning strike, blade icing, earthquakes, tornados, extreme winds, severe storms and wildfires), accidents or other unforeseen events. For example, the construction of our El Bracho ST power plant may be delayed due to the loss of certain equipment needed for project completion. For more information, see “Business – Our Projects – Thermal Energy – El Bracho ST.” We cannot assure you that construction projects will not be delayed for reasons beyond our control, that we will obtain financing at terms convenient for us, that we will obtain all the necessary approvals in time (or at all), or that cost overruns would not be material. Any such circumstances may have a material adverse effect on our business, financial condition or results of operations.

***Failure to perform under our PPAs or early termination under our PPAs and governmental authorizations, could materially and adversely affect our results of operations and our capacity of making payments on the Notes.***

If we breach our obligations under the PPAs or fail to obtain and maintain any required governmental approvals, or we do not comply with applicable rules and regulations in Argentina, we may be subject to sanctions by the SGE or other relevant governmental agencies, including warnings, fines, provisional administration, early termination of the PPAs or the relevant governmental approvals. For example, continued and material failures in availability to supply or to supply when requested by CAMMESA may be an event of default under our PPAs with CAMMESA. CAMMESA may terminate our PPAs at its option and as of a date of its choosing upon the occurrence of any of the events of default set forth therein, and for as long as the alleged event of default has not been cured. We may also terminate our PPAs with CAMMESA upon an event of default of CAMMESA. No assurance can be given that the amounts we are entitled to receive under the PPAs or applicable law in connection with any early termination of the PPAs will be received, or if received, will be sufficient to compensate us for our loss.

As a result, sanctions may have a material adverse effect on our business, results of operations and financial condition, and could impair our ability to make payments under the Notes.

***We may not be able to renew our PPAs or enter into new PPAs for the sale of firm capacity and electricity in the future, or such PPAs may be unilaterally modified or terminated.***

During the year ended December 31, 2018 and the three-month period ended March 31, 2019, our revenues derived under our PPAs were 48.4% and 60.5%, respectively. As of March 31, 2019, our PPAs for operating power plants had a weighted average remaining term of approximately 13 years and our PPAs for projects under construction had a weighted average remaining term of approximately 16 years. See “Business—Our Revenues—Our PPAs.” In connection with the existing PPAs, we may not be able to renew our PPAs or enter into new PPAs with our current clients on favorable terms or at all. Moreover, the terms and conditions of such PPAs with CAMMESA may be modified or terminated unilaterally, or even be subject to breach of contract for reasons beyond our control.

In addition, we sell and expect to sell a portion of our electricity generated by our wind farm and wind farm projects under construction under PPAs with large users in the MATER. However, following the completion of our wind farm projects, we may not be able to enter into PPAs with new or existing customers or enter into PPAs for the sale of such capacity on favorable terms.

The failure to enter into new PPAs for our new capacity, the non-renewal, termination or modification in a manner materially adverse to our interests of any of our existing PPAs could have a material adverse effect on our business and results of operations.

***The operation of power plants involves operating risks, availability risks, technology risks and other risks beyond our control.***

The operation of power plants involves risks, including, among others:

- the possibility that our power plants will perform below expected levels of output efficiency or fail to conform to their design specifications;
- the failure to meet, or the decrease of, plant capacity, due to high ambient temperatures or degradation due to age, which decrease the operable capacity and efficiency;
- interruptions or prolonged shutdowns of operations due to wear and tear, defects, design errors or the breakdown, malfunction or failure of equipment or processes, unexpected maintenance or future construction requirements, or shortages of replacement equipment;
- unanticipated costs of operations and maintenance, including in the case of thermal plants, the cost of fuel in excess of the guaranteed heat rate of the generating units installed in each power plant (the “Guaranteed Heat Rate”) or due to excessive dispatch;
- labor disputes or labor shortages, including our inability to hire and retain personnel with the necessary expertise to operate the plants;
- our failure to obtain or renew required governmental permits;
- our inability to comply with the operating standards and limits established by our governmental permits, or with current or future environmental, health and or regulations;
- operator errors that could result in loss of life, bodily injury or destruction of property, and/or the decrease of availability of the plant and/or production;
- disruption or failure of our information and processing systems;
- the effects of actions by third parties, such as generation companies and other transmission companies and users;
- force majeure events, such as catastrophic events including fires, earthquakes, lightning, explosions, droughts, floods, terrorist acts, sabotage, acts of war or other occurrences that could result in personal injury, loss of life, environmental damage or severe damage to, or destruction of, the power plants, and suspension of its operations;
- government exercise of eminent domain power or similar events of expropriation, the compensation for which may be insufficient to compensate us for our losses;
- changes in law or governmental permit requirements, including, but not limited to, required changes in the fees we receive for our generating capacity and output, other terms and conditions of our agreements with governmental suppliers and offtakers, the imposition or modification of our obligations with respect to third parties, the modification of the terms on which CAMMESA supplies fuel and/or compensates fuel costs, and the imposition of obligations to increase the generating capacity of our power plants;
- existence of liens, encumbrances, and other imperfections in title affecting our real estate interests;
- inflation and cost increases in excess of our expectations; and
- litigation or claims against us.

The occurrence of any of the foregoing or other events could temporarily or permanently disrupt our operations, significantly reduce or eliminate our revenues or significantly increase the costs of operating the power plants, including maintenance and repair costs, or require us to make substantial capital expenditures, thereby impairing our ability to make payments on the Notes. The proceeds of any available insurance and limited warranties may not be adequate to cover our lost revenues or increased costs.

***Our power plants are subject to the risk of mechanical or electrical failures and any resulting unavailability may affect our ability to fulfill our contractual and other commitments and thus adversely affect our business and financial performance.***

Our power generation units are at risk of mechanical or electrical failure and may experience periods of unavailability affecting our ability to generate electric power. Under the majority of our PPAs and under Energía Base we are mainly compensated for the availability of our thermal power plants and, to a lesser extent, for the energy we dispatch. In turn, under our PPAs related to our renewable energy plants we are compensated for the energy we dispatch to the SADI. Therefore, any unplanned unavailability of our generation facilities may adversely affect our ability to perform under our PPAs or Energía Base, which may adversely impact our financial condition or results of operations.

***We depend to a large extent on third parties to maintain our power plants and wind farms and will rely on third parties to complete the procurement, engineering, construction, testing and commissioning of our expansion projects.***

We depend to a large extent on third parties, including our shareholder General Electric, to perform certain maintenance services related to our power plants. Additionally, we will rely on third parties to complete the procurement, engineering, construction, testing and commissioning of our expansion projects. If any power plant fails to have the capacity and performance capabilities that we intend, or if any entity upon which we depend to meet our obligations under our PPAs breaches its obligations to us, or if a counterparty to any of our material contracts is declared bankrupt or insolvent, our ability to complete the expansion of our generation capacity, and consequently our ability to meet our obligations under the PPAs would be impaired. Shortages of critical spare parts, maintenance service and new equipment and machinery required for the operation, expansion and conversion of our power plants could also adversely affect our business, results of operations and financial condition. Unless we are able to enter into replacement contracts to obtain the needed services and equipment from alternative sources (and on reasonable terms), any such event could materially adversely affect our ability to make payments on the Notes.

***The EPC Agreements to which we are or may become a party contain limitations on liability and damages that could prevent us from being fully compensated for defects, delays, and other adverse outcomes attributable to EPC Contractors.***

We have entered into certain EPC Agreements with affiliates of General Electric, Vestas, Wartsila and AESA, and we are currently negotiating new EPC Agreements to complete the procurement, engineering, construction, testing and commissioning of certain of our expansion projects.

Under the EPC Agreements executed with our EPC Contractors, their liability is limited, and excludes consequential and other indirect damages. We expect that the EPC Agreements under negotiation will include similar limitations. In the event that for reasons attributable to our EPC Contractors or other providers for the construction of our power plants suffer from delays, defects, damage, or failure to conform to designs or performance standards, we may incur significant costs of completion or repair, in addition to significant penalties under, or termination of, certain of our PPAs. Because of the liability limits contained in these EPC Agreements, damages available from our EPC Contractors could, in many cases, be insufficient to compensate us for our losses.

Further, certain causes of delays and/or damages are completely excluded from our EPC Contractors' liability, such as actions of governmental authorities which may include equipment delays in clearing Argentine customs.



As a result, damages under our EPC Agreements or other EPC Agreements that we expect to enter into are unlikely to be sufficient to compensate us for any losses, which may materially and adversely affect our ability to make payment on the Notes.

***Our activities will require significant capital expenditures to satisfy ongoing maintenance requirements and the expansion of our installed capacity.***

We will need to make capital expenditures to finance ongoing maintenance requirements that will allow us to continue generating energy and carry out our operations, as well as to improve our plants' ability to generate electricity. Moreover, investments in capital goods will also be required to finance the cost of the present and future expansion of our generation capacity. If we are not able to finance such investments or fail to do so on satisfactory terms, our activities, financial condition, and the results of our operations may be adversely affected. The financial ability of the Company could be adversely affected by market restrictions in terms of availability of financing for Argentine companies.

***Our insurance policies may not fully cover damage, and we may not be able to obtain insurance against certain risks.***

We maintain insurance coverage to mitigate the principal risks inherent in the industry in which we operate. Insurance policies to cover some risks, such as environmental risks, are not currently available in Argentina. We cannot assure you of the availability or adequacy of the risk coverage in relation to any particular risk or loss. If an accident or other event occurs that is not covered by our current insurance policies, if the losses exceed the amount for which we are insured, or if insurance companies fail to compensate us for losses that are covered under our insurance policies, we may experience significant losses or be required to disburse significant amounts of our own funds, all of which could adversely affect our business, results of operations and financial condition. We cannot assure you that we will not be adversely affected by insufficiency in our insurance policies.

***We may experience difficulties obtaining the performance bonds that we require in the normal course of our operations or may face challenges in meeting potential reimbursement obligations arising therefrom.***

We are required to obtain and maintain performance bonds to secure compliance with our obligations under our PPAs with CAMMESA either until reaching commercial operation or throughout their term, and to secure our bids in bidding processes for new generation capacity or for dispatch priority granted in the MATER and we may experience difficulties obtaining or maintaining them. In addition, we may be subject to obligations to reimburse amounts drawn with respect to any such instruments in the event there is a drawdown on any such instrument due to our failure to satisfactorily perform our obligations under the agreements to which such instruments may be issued.

Failure to maintain or provide performance bonds or other forms of guarantees, or any failure to reimburse potential obligations arising from a drawdown thereunder, could have a material adverse effect on our business and results of operations.

***Our equipment, facilities and operations are subject to environmental, health and safety regulations, and those might have an impact on the business.***

Our generation business is subject to federal and provincial laws, as well as to the supervision of governmental agencies and regulatory authorities in charge of enforcing environmental laws and policies. We operate in compliance with applicable laws and in accordance with directives issued by the relevant authorities and CAMMESA; however, it is possible that we could be subject to regulations, which could result in penalties being imposed on us. In addition, future environmental regulations could require us to make investments in order to comply with the requirements set by the authorities, instead of making other scheduled investments and, as a result, could have a material adverse effect on our financial condition and our results of operations.

***Our generation operations require us to handle hazardous elements such as fuels, which could potentially result in damage to our facilities or injuries to our personnel.***

As part of our business, we handle, store and manage in our facilities the fuels that are used in our thermal power plants. Any accident involving fuels could have adverse environmental consequences, cause bodily injuries to our personnel, and could damage our industrial facilities and our reputation. Any such consequences could cause significant damage to our facilities, interrupt the generation of energy in such facilities for an extended period of time, cause investigations by regulatory authorities that could derive in closures or other measures which, in each case, could adversely affect our business, results of operations and financial condition.

***We may be exposed to lawsuits and administrative proceedings that could adversely affect our financial condition and results of operations.***

Our business may expose us to litigation relating to labor, regulatory, environmental, tax and administrative proceedings, governmental investigations, tort claims, contract disputes and criminal prosecution, among other matters. In the ordinary course of our business we enter into agreements with customers, offtakers, contractors, providers and other parties that could derive in disputes. Even though we do not currently have any material litigation or administrative proceeding, litigation and/or regulatory proceedings are inherently unpredictable, and excessive verdicts do occur. Adverse outcomes in lawsuits and investigations could result in significant monetary damages, including indemnification payments, or injunctive relief that could adversely affect our ability to conduct our business and may have a material adverse effect on our financial condition and results of operations.

***We may undertake acquisitions and investments to expand or complement our operations that could result in operating difficulties or otherwise adversely affect our financial conditions and results of operations.***

In order to expand our business, from time to time, we may carry out acquisitions and investments which offer added value and are consistent with or complementary to our business strategy. For example, in February 2018, effective as of January 5, 2018, we acquired the LPC I power plant from Central Puerto S.A. LPC I has an installed capacity of 128 MW and the electrical power it generates is delivered to the WEM and remunerated by means of Resolution No. 1/2019 or Energía Base, whereas the generated steam is sold to YPF. In addition, we recently acquired the Los Teros I and Los Teros II projects and participated in an auction process to supply energy in the MATER. We are currently constructing these wind farms.

In connection with potential acquisition and investment transactions, we may be exposed to various risks, including those arising from: (i) not having accurately assessed the value, future growth potential, strengths, weaknesses and potential profitability of potential acquisition targets; (ii) difficulties in successfully integrating, operating, maintaining or managing newly-acquired operations, including personnel; (iii) unexpected costs of such transactions; (iv) lack of financing to fund such acquisition, or (v) unexpected contingent or other liabilities or claims that may arise from such transactions. If any of these risks were to materialize, it could adversely affect our business, results of operations and financial condition.

***If we were to acquire another energy company in the future, such acquisition could be subject to the Argentine Antitrust Authority's approval.***

The Argentine Antitrust Law provides that any transactions involving the acquisition, transfer or control of another company's assets will be subject to the Argentine Antitrust Authority consent and approval in the event that (i) the total revenues of the companies involved for the last fiscal year exceeds the sum of 100 million adjustable units (equal to Ps. 2,640 million) in Argentina; and (ii) the transaction amount or the value of the transferred assets located in Argentina exceeds 20 million adjustable units (equal to Ps. 528 million). All the amounts set out by the Argentine Antitrust Law are fixed in adjustable units, which will be adjusted on an annual basis. As of the date of this offering memorandum the value of one adjustable unit is equivalent to Ps. 26.40.

The Argentine Antitrust Authority will determine whether any acquisition subject to its approval negatively impacts competitive conditions in the markets in which we compete or adversely affects consumers in these markets. A business combination executed by us could be rejected by the Argentine Antitrust Authority, or the later could take

actions to impose conditions or performance commitments on us as part of the approval process. If so, it could adversely affect our business, results of operations and financial condition and prevent us from achieving the anticipated benefits of such acquisition.

***We depend on senior management and other key personnel for our current and future performance.***

Our current and future performance depends to a significant degree on our qualified senior management team, and on our ability to attract and retain qualified management. Our future operations could be adversely affected if any of our senior executives or other key personnel ceased working for us. Competition for senior management personnel is intense, and we may not be able to retain our personnel or attract additional qualified personnel. The loss of a member of senior management may require the remaining executive officers to divert immediate and substantial attention to fulfilling his or her duties and to seeking a replacement. Any inability to fill vacancies in our senior executive positions on a timely basis could harm our ability to implement our business strategy, which would harm our business and results of operations.

***We could be affected by material actions taken by labor unions.***

Labor claims are common in the Argentina energy sector, and in the past, unionized employees have blocked access and caused damages to the facilities of various companies in the industry. Moreover, we have no insurance coverage for business interruptions caused by workers' actions or in the event such interruptions materially damage our facilities, which could have an adverse effect on our results of operations. We may face significant pressures from labor unions to increase salaries and other benefits, particularly in the event of inflation. An increase of salaries or other employee benefits may have a material adverse effect on our results of operations. In addition, strikes, stoppages and other labor actions may have a material adverse effect on our business and results of operations.

***We are subject to anti-corruption, anti-bribery, anti-money laundering, tax, antitrust and other laws and regulations.***

We are subject to anti-corruption, anti-bribery, anti-money laundering, tax, antitrust and other laws and regulations. We may be subject to investigations and proceedings by authorities for alleged violations of these laws. These proceedings may result in fines or other liabilities and could have a material adverse effect on our reputation, business, financial conditions and result of operations. In addition, since the Corporate Criminal Liability Law entered into effect, we may be responsible for the commission of certain criminal offenses committed by officers, employees or shareholders including bribery and other corruption offenders. If any officers, employees or other persons engage in fraudulent, corrupt or other unfair business practices or otherwise violate applicable laws, regulations or internal controls, we could become subject to one or more enforcement actions or otherwise be found to be in violation of such laws, which may result in penalties, fines and sanctions and in turn adversely affect our reputation, business, financial condition and result of operations.

***Our operations can have a negative impact on local communities and may encounter significant opposition from different groups.***

Our operations can have a negative impact on local communities. Failure to manage relationships with local communities, governments and non-governmental organizations may harm our reputation as well as our ability to bring development projects into production. In addition, the costs and management time required to comply with standards of social responsibility, community relations and sustainability may increase substantially over time.

The development of new and existing power plants may face opposition from several stakeholders, such as, environmental groups, land owners, farmers, local communities and political parties, among others, all of which may impact our reputation and goodwill. The operation of our current thermal power plants may also affect our goodwill with stakeholders, due to the emissions of effluent liquids, sounds, water steam, natural gas, particulate matter and gas emissions, such as sulfur dioxide, carbon dioxide and nitrogen oxides. Damage to our relationship with stakeholders could prevent us from continuing to operate our current assets or prevent us from winning and developing new projects, which, in turn, could adversely affect our business, results of operations and financial condition.

***Our business is subject to risks arising from natural disasters, catastrophic accidents and terrorist attacks.***

Our generation facilities, or the third-party fuel transportation or electric power transmission infrastructure that we rely on, may be damaged by flooding, fires, earthquakes and other catastrophic disasters arising from natural or accidental or intentional human causes. We could experience severe business disruptions, significant decreases in revenues based on lower demand arising from catastrophic events, or significant additional costs to us not otherwise covered by business interruption insurance clauses. There may be a significant time lag between a major accident, catastrophic event or terrorist attack and our definitive recovery from our insurance policies, which typically carry non-recoverable deductible amounts, and in any event are subject to caps per event. In addition, any of these events could cause adverse effects on the energy demand of some of our customers and of consumers generally in the affected market. Some of these considerations could have a material adverse effect on our business, financial condition and our result of operations.

***We could be harmed by a failure or interruption of our information technology systems or automated machinery.***

We rely on our information technology systems and automated machinery to effectively manage our generating processes. Even advanced technology systems and machinery, however, are subject to defects, interruptions and breakdowns. In addition, our information technology systems and automated machinery may be vulnerable to damage or interruption from circumstances beyond our control, including fire, natural disasters, system failures, viruses and security breaches, including breaches of our production processing systems. Any failure of our information technology systems and automated machinery to perform as we anticipate could disrupt our operations, reduce our efficiency, or result in damage to our equipment. As a result, we may not be able to generate electrical power as and when required by our PPAs, or we may fail to meet the fuel efficiency standards which determine the amount CAMMESA will compensate us for our fuel costs. We may incur significant penalties and lost revenues under our PPAs, and may incur significant costs to repair or upgrade our information technology systems and automated machinery. As a result, any such interruption or damage could have a material adverse effect on our business results and could impair our ability to make payments under the Notes.

In addition, information security risks have generally increased in recent years as a result of the proliferation of new technologies and the increased sophistication and activities of cyber-attacks. We have increasingly connected our equipment and systems to the internet. Because of the critical nature of our infrastructure and the increased accessibility enabled through connection to the internet, we may face a heightened risk of cyber-attack. In the event of such an attack, we could have our business operations disrupted, property damaged and customer information stolen; experience substantial loss of revenues, response costs and other finance loss; and be subject to increased litigation and damage to our reputation. A cyber-attack could adversely affect our business, results of operations and financial condition.

**Risks Relating to the Notes**

***This offering memorandum contains only limited financial and operating information on which you can make an investment decision with respect to the Notes.***

This offering memorandum contains only limited financial and operating information on which you can make an investment decision with respect to the Notes. The year ended December 31, 2018 is the first time we have prepared our financial statements in accordance with IFRS. Our Financial Statements included in this offering memorandum, only include financial information for the years ended December 31, 2018 and 2017 and for the three-month period ended March 31, 2019 and 2018. However, we have undertaken multiple significant transactions in 2017 and 2018 to date which make our results of operations across periods not comparable. See “Presentation of Financial and Other Information – Comparability of Historical Financial Information.” For more information, see “Management’s Discussion and Analysis of Financial Condition and Results of Operations—Financial Presentation.” In addition, our functional currency, as defined by our board of directors, is the U.S. dollar while our financial statements are presented in pesos. Therefore, pronounced variations of the peso with respect to the U.S. dollar may affect our results of operations as measured in U.S. dollars.

***The Notes may not be a suitable investment for all investors.***

Each potential investor in the Notes must determine the suitability of that investment in light of its own circumstances. In particular, each potential investor should:

- have sufficient knowledge and experience to make a meaningful evaluation of the Notes, the merits and risks of investing in the Notes and the information contained in this offering memorandum or any applicable supplement;
- have access to, and knowledge of, appropriate analytical tools to evaluate, in the context of its particular financial situation, an investment in the Notes and the impact the Notes will have on its overall investment portfolio;
- have sufficient financial resources and liquidity to bear all of the risks of an investment in the Notes; understand thoroughly the terms of the Notes and be familiar with the behavior of any relevant indices and financial markets; and
- be able to evaluate (either alone or with the help of a financial adviser) possible scenarios for economic, interest rate and other factors that may affect its investment and its ability to bear the applicable risks.

***Our indebtedness could adversely affect our financial condition and prevent us from fulfilling our obligations, including our obligations under the Notes.***

As of March 31, 2019, our total debt was US\$ 643.7 million. Moreover, we intend to incur a significant amount of additional debt to finance our expansion strategy.

The level of our indebtedness could have important consequences to you, including the following:

- it may limit our ability to borrow money to fund our working capital needs and capital expenditures;
- it may limit our flexibility in planning for, or reacting to, changes in our business and industry sector, in particular our ability to take advantage of future business opportunities;
- it may make us more vulnerable to a downturn in our business or industry sector, as well as in the Argentine or international economy, including increases in interest rates, foreign currency exchange rate fluctuations and market volatility;
- it may place us at a competitive disadvantage compared to our competitors with lower levels of indebtedness;
- it may make more difficult for us to generate sufficient cash flow to satisfy our obligations with respect to the Notes;
- a material portion of our cash flow from operations will be dedicated to the repayment of our indebtedness, and will not be available for other purposes; and
- there would be a material adverse effect on our business and financial condition if we were unable to service our indebtedness or obtain additional financing as needed.

Although the Indenture will restrict our ability to incur additional indebtedness, these restrictions are subject to a number of qualifications and exceptions, and the indebtedness we may incur in compliance with these restrictions could be significant. For more information about the restrictive covenant related to limitation on debt, see “Description of the Notes—Certain Covenants—Limitation on Indebtedness”.

We may not be able to generate the significant amount of cash flow needed to pay interest and principal amounts on all of our debts as they become due, including principal and interest on the Notes and any future indebtedness, which could result in our inability to fulfill our obligations under the Notes. In addition, we may be required to refinance our indebtedness as it becomes due, including the Notes, and we cannot assure you that we will be able to do so.

***The Indenture will impose significant operating and financial restrictions on us which may prevent us from capitalizing on business opportunities.***

The Indenture will contain covenants that will, among other things, limit our ability to:

- incur additional indebtedness;
- pay dividends or make distributions or repurchase or redeem stock;
- prepay, redeem or repurchase certain indebtedness;
- make loans and investments;
- sell assets;
- incur liens; and
- consolidate, merge or sell all or substantially all of our assets.

These covenants will be subject to a number of exceptions and qualifications. For more details, see “Description of the Notes—Certain Covenants.” Notwithstanding, these restrictions could limit our ability to seize attractive growth opportunities for our businesses that are currently unforeseeable, particularly if we are unable to incur financing or make investments to take advantage of these opportunities. In addition, the breach of any of these covenants or the failure to meet any of such conditions could result in a default under the Notes. Our ability to comply with these covenants may be affected by events beyond our control, including prevailing economic, financial and industry conditions and the authorizations used in our business.

***The Issuer has, and is permitted to create unrestricted subsidiaries, which will not be subject to certain of the covenants in the Indenture, and we may not be able to rely on the cash flow or assets of unrestricted subsidiaries to pay our indebtedness.***

The Indenture permits the Issuer to designate certain of its subsidiaries as unrestricted subsidiaries, which subsidiaries would not be subject to the restrictive covenants in the Indenture. On the issue date, the Issuer will not have any unrestricted subsidiaries. However, it may designate unrestricted subsidiaries in the future. Any unrestricted subsidiaries would be able to engage in many of the activities the Indenture would otherwise prohibit, such as incurring substantial additional debt (secured or unsecured), making investments, selling, encumbering or disposing of substantial assets, entering into transactions with affiliates and entering into mergers or other business combinations. These actions could be detrimental to our ability to make payments when due and to comply with our other obligations under the terms of our outstanding indebtedness.

In addition, the initiation of bankruptcy or insolvency proceedings or the entering of a judgment against an unrestricted subsidiary, or an unrestricted subsidiary’s default under its other credit arrangements will not result in an event of default under the Indenture.

***We may incur additional obligations ranking equal to the Notes or senior to the Notes as a result of flexibility provided to us in the Description of Notes.***

The Indenture will permit the Issuer and any of its restricted subsidiaries to incur additional obligations, including borrowed money, bonds, debentures, notes or other similar instruments and certain other obligations. In

order to incur additional indebtedness, we will be subject to certain customary permitted indebtedness items. Within our debt incurrence capacity, we are permitted to incur certain customary permitted liens.

If we incur additional obligations that rank on an equal and ratable basis with the Notes, the beneficiaries of those obligations would be entitled to share ratably with the holders of the Notes in any proceeds that may be distributed upon our insolvency, liquidation, reorganization, dissolution or other winding up. This would reduce the amount of any liquidation proceeds that would be available to be paid to the holders of the Notes. Furthermore, if we incur secured obligations that rank senior to the Notes, the secured creditors would be entitled to the proceeds upon an insolvency before the holders of the Notes to the extent of the value of the assets securing such secured obligations and would significantly reduce the amount of any liquidation proceeds that would be available to the holders of the Notes.

***We may be unable to service our indebtedness, including the Notes.***

Our ability to make scheduled payments on and to refinance our indebtedness, including the Notes, depends on and is subject to our financial and operating performance, which in turn is affected by general and regional economic, financial, competitive, business and other factors, including the availability of financing in the banking and capital markets as well as the other risks described herein. We cannot assure you that our business will generate sufficient cash flow from operations or that future borrowings will be available to us in an amount sufficient to enable us to service our debt, including the Notes, to refinance our debt or to fund our other liquidity needs. If we are unable to meet our debt obligations or to fund our other liquidity needs, we will need to restructure or refinance all or a portion of our debt, including the Notes, which could cause us to default on our debt obligations and impair our liquidity. Any refinancing of our indebtedness could be at higher interest rates and may require us to comply with more onerous covenants which could further restrict our business operations.

***Developments in other emerging markets may adversely affect the market value of the Notes.***

The market price of the Notes may be adversely affected by developments in the international financial markets and world economic conditions. Argentine securities markets are influenced, to varying degrees, by economic and market conditions in other countries, especially those in Latin America and other emerging markets. Although economic conditions are different in each country, investor reaction to the developments in one country may affect the securities of issuers in other countries, including Argentina. We cannot assure you that the market for the securities of Argentine issuers will not be affected negatively by events elsewhere or that such developments will not have a negative impact on the market value of the Notes. For example, an increase in the interest rates in a developed country, such as the United States, or a negative event in an emerging market, may induce a significant capital outflow from Argentina and depress the trading price of the Notes.

***There is no established trading market for the Notes and the market value of the Notes is uncertain.***

Although we will apply to list the Notes for trading on the MAE and to have the Notes listed on the Official List of the Luxembourg Stock Exchange for trading on its Euro MTF Market, the Notes will be new issues of securities with no established trading market or prior trading history. We cannot assure you that any such applications would be approved. In addition, we cannot assure you that a market for the Notes will develop or, if one does develop, that it will be maintained. If a trading market does not develop or is not maintained, you may experience difficulty in reselling the Notes or may be unable to sell them at an attractive price or at all. Further, even if a market develops, the liquidity of any market for the Notes will depend on the number of holders of the Notes, the interest of securities dealers in making a market in the Notes and other factors. Furthermore, the market value and liquidity of, and trading markets for, the Notes may be materially and adversely affected by changes in interest rates and declines and volatility in the markets for similar securities and in the overall economy, as well as by any changes in our financial condition or results of operations. We cannot assure you that the Notes will not trade at a discount from their initial trading price, whether for reasons related or unrelated to us. The initial purchasers are not under any obligation to make a market with respect to the Notes. Accordingly, no assurance can be given as to the development or liquidity of any trading market for the Notes. If an active market for the Notes does not develop or is interrupted, the market price and liquidity of the Notes may be adversely affected.

***The Notes are not registered securities in the United States, and they will be subject to transfer restrictions that may adversely affect the value of the Notes and limit your ability to resell the Notes.***

The Notes have not been registered under the Securities Act or any state securities laws, and we are not required to and currently do not plan on making any such registration in the immediate future. The Notes may not be offered or sold except pursuant to an exemption from, or in a transaction not subject to, the registration requirements of the Securities Act and applicable state securities laws. Such exemptions include offers and sales that occur outside the United States for non-U.S. persons in compliance with Regulation S and in accordance with any applicable securities laws of any other jurisdiction, and sales to U.S. qualified institutional buyers as defined under Rule 144A. You should be aware that investors may be required to bear the financial risks of this investment for an indefinite period of time. See “Transfer Restrictions” for a more detailed explanation of such restrictions.

***The ratings of the Notes may be downgraded or withdrawn depending on various factors, including the rating agency’s assessments of our financial strength and Argentina’s sovereign risk.***

We have been assigned credit ratings from certain rating agencies for the Notes. Ratings address the timely payment of interest on each interest payment date and principal at maturity. Such ratings are limited in scope, and do not address all material risks relating to an investment in the Notes, but rather reflect only the views of the rating agencies at the time the ratings are issued. The ratings of the Notes are not a recommendation to purchase, hold or sell the Notes, may be changed, suspended or withdrawn by the rating agency at any time and do not comment on market price or suitability of the Notes as an investment for a particular investor. Our current ratings and the rating outlooks currently assigned to us are, and any ratings attributed to the Notes will be, dependent upon economic conditions and other factors affecting credit risk that are outside our control. Each rating should be evaluated independently of the others. Detailed explanations of the ratings may be obtained from the rating agencies. We cannot assure you that such credit ratings will remain in effect for any given period of time or that such ratings will not be lowered, suspended or withdrawn entirely by the rating agencies, if, in the judgment of such rating agencies, circumstances so warrant. Negative developments in our business, financial condition and results of operations or other factors could cause the ratings agencies to lower the credit ratings, or ratings outlook, of our short- and long term debt, which may impair our ability to raise new financing or refinance our current borrowings and increase our costs of issuing any new debt instruments. A rating’s downgrade or the removal of ratings could have an adverse effect on the price and marketability of the Notes.

***The Notes will be effectively subordinated to our existing and future secured indebtedness and certain claims preferred by law and other liabilities of our subsidiaries.***

The Notes will be unsecured obligations and will be effectively subordinated to existing and future secured indebtedness. For more information on our secured debt, see “Management’s Discussion and Analysis of Financial Condition and Results of Operations—Liquidity and Capital Resources—Indebtedness.” Moreover, under Argentine bankruptcy law, the Notes are subordinated to certain statutory preferences, including claims for salaries, wages, social security, taxes and court fees and expenses.

To finance our expansion strategy, we intend to incur additional indebtedness, some of which will be secured by certain of our assets and those of our subsidiaries. Although the Indenture contains restrictions on our ability to incur secured debt, these restrictions are subject to significant exceptions. For more information, see “Description of the Notes—Certain Defined Terms—Permitted Liens.”

If we become insolvent or are liquidated, or if payment under any secured debt is accelerated, the lenders thereunder would be entitled to exercise the remedies available to a secured lender. Accordingly, the lender would have priority over any claim for payment under the Notes to the extent of the value of the assets that constitute its collateral. If this were to occur, it is possible that there would be no assets remaining from which claims of the holders of the Notes could be satisfied. Further, if any assets did remain after payment of these lenders, the remaining assets might be insufficient to satisfy the claims of the holders of the Notes and holders of other unsecured debt that is deemed the same class as the Notes, and potentially all other general creditors who would participate ratably with holders of the Notes.



The Notes will be structurally subordinated to all existing and future debt and other liabilities of our subsidiaries. In the event of a bankruptcy, liquidation or reorganization of any of our subsidiaries, holders of their indebtedness and their creditors will generally be entitled to payment of their claims from the assets of those subsidiaries before any assets are made available for distribution to us and, in turn, to our creditors, including holders of the Notes.

***We may not be able to repurchase the Notes upon a change of control.***

Upon the occurrence of a Change of Control Repurchase Event as described in “Description of the Notes—Repurchase of Notes upon a Change of Control Repurchase Event” we will be required to offer to repurchase all outstanding Notes at 101% of their principal amount plus accrued and unpaid interest, if any, to the repurchase date. The source of funds for any such purchase of the Notes will be our available cash or cash generated from our subsidiaries’ operations or other sources, including borrowings, sales of assets or sales of equity. We may not be able to repurchase the Notes upon a Change of Control Repurchase Event because we may not have sufficient financial resources to purchase all of the Notes that are tendered upon a Change of Control Offer. Our failure to repurchase the Notes upon a Change of Control Repurchase Event would cause a default under the Indenture. We cannot assure you that our future indebtedness will not prohibit us from purchasing Notes in the event of a change of control, provide that a change of control is a default or require repurchase upon a change of control. Moreover, the exercise by the holders of Notes of their right to require us to purchase the Notes offered hereby under the Indenture could cause a default under other debt, even if the change of control itself does not, due to the financial effect of the purchase on us.

***We may make investments and make other restricted payments even when highly leveraged.***

The Indenture will restrict our ability and that of our restricted subsidiaries to make certain restricted payments, including paying dividends, making distributions or redemptions with respect to our capital stock or making payments on debt that is subordinated to the Notes. However, these restrictions are subject to significant exceptions. Moreover, the Indenture does not fully restrict our ability and that of our restricted subsidiaries to make investments, including investments in unrestricted project finance subsidiaries. See “Description of Notes—Certain Covenants—Limitation on Restricted Payments” and “Description of Notes—Certain Definitions—Permitted Investments.”

***We may redeem the Notes prior to maturity.***

The Notes are redeemable at our option under certain circumstances specified in “Description of the Notes—Redemption and Repurchase.” We may choose to redeem the Notes at times when prevailing interest rates may be relatively low. Accordingly, an investor may not be able to reinvest the redemption proceeds in a comparable security at an effective interest rate as high as that of the Notes.

***Holders of the Notes may find it difficult to enforce judgments against us, our directors, officers, controlling persons and certain experts.***

We are organized under the laws of Argentina. Substantially all of our directors and all of our officers, as well as many of the experts named in this offering memorandum, reside in Argentina. In addition, all or a substantial portion of our assets and the assets of our directors and officers are located outside of the United States. As a result, it may be difficult or impossible for holders of the Notes to effect service of process within the United States on us or on such persons. Based on the opinion of our Argentine counsel, there is doubt as to the enforceability against us and such persons in Argentina, whether in original actions or in actions to enforce judgments of U.S. courts or other non-Argentine courts. See “Enforcement of Judgments Against Foreign Persons.”

In addition, Argentine courts will not order the attachment prior to execution and attachment in aid of execution on any property located in Argentina and determined by such courts to be essential for the provision of public services. The assets related to our power generation business are considered part of an activity of general interest (*actividad de interés general*) and attachment thereon is not restricted as a matter of law. If an Argentine court were to make such a determination with respect to any of our assets, unless the Argentine government expressly grants a waiver to the extent permitted under applicable law, such assets would not be subject to attachment, execution or other

legal processes as long as the determination stands, and, as a result, the ability of our creditors to enforce a judgment against such assets may be adversely affected. See “Enforcement of Judgments against Foreign Persons.”

***In the event of reorganization proceedings or an out-of-court reorganization agreement, noteholders might vote differently from other creditors.***

In the event we are subject to judicial reorganization proceedings, out-of-court reorganization agreements (*acuerdos preventivos extrajudiciales*) and/or similar proceedings, current Argentine law applicable to the Notes (including, without limitation, the provisions of the Argentine Negotiable Obligations Law) will be subject to the provisions of Argentine Law No. 24,522 (the “Argentine Bankruptcy Law”), as amended, and other regulations applicable to business restructuring proceedings and, consequently, certain terms and conditions of the Notes may not be enforced. Argentine bankruptcy procedures pursuant to the Argentine Bankruptcy Law differ from those applied in the United States.

The Argentine Bankruptcy Law establishes a different voting procedure for noteholders from that used by other unsecured creditors for purposes of calculating the majorities required by the Argentine Bankruptcy Law (which requires the absolute majority of creditors representing two-thirds of the unsecured debt). Under this system, noteholders may have significantly less bargaining power than our other financial creditors in the event of reorganization.

Moreover, Argentine case law has provided that those noteholders who fail to attend a meeting at which a vote is held in order to vote or who abstain from voting are not to be counted for purposes of calculating such majorities. As a result of these reorganization proceedings, the bargaining power of noteholders may be lessened vis-à-vis our other financial and trade creditors.

***In the event we become subject to a bankruptcy or liquidation reorganization proceeding or if we enter into an out-of-court reorganization agreement and/or similar proceedings, certain terms and conditions of the Notes may not apply under Argentine law.***

In the event we are subject to judicial reorganization proceedings, out-of-court reorganization agreements and/or similar proceedings related to us, current Argentine regulations applicable to the Notes (including, without limitation, the provisions of the Argentine Negotiable Obligations Law) will be subject to the provisions of the Argentine Bankruptcy Law as amended, and other laws and regulations applicable to business reorganization proceedings and, consequently certain terms and conditions of the Notes may not apply (*e.g.*, unanimous approval of holders to amend certain provisions of the Notes). Argentine bankruptcy procedures pursuant to the Argentine Bankruptcy Law differ from those applied in the United States.

Specifically, the Argentine Bankruptcy Law establishes that, in the case of securities issued in series, such as the Notes, the holders thereof will participate in the voting to obtain the necessary consent to approve an agreement with creditors and/or the restructuring of our debts subject to a procedure for the calculation of majorities different from those required with respect to other unsecured creditors. Under this procedure: (i) a meeting of holders will be called by the trustee or the competent judge, as applicable; (ii) the holders present in such meeting will vote in favor or against the proposed restructure plan indicating the selected option, in case the plan is approved; (iii) the plan will be considered approved or rejected considering the aggregate principal amount voting in favor and the aggregate principal amount voting against the proposal plus the agreement of the other creditors; (iv) the decision will be stated for the record by the trustee or the person appointed to such end by the meeting and evidenced by the meeting minutes; (v) a meeting of holders may not be called if the applicable laws or regulations permit a different method for obtaining the consent of creditors satisfactory to the judge; (vi) in the event the trustee were considered the creditor pursuant to the relevant proof of claims, as established in Section 32 of the Bankruptcy Law, it may divide its vote, voting in favor of the proposed plan with respect to the principal amount held by the beneficiary holders, who are also entitled to participate in the meeting, instructing it to accept the same as established in the Indenture or the applicable law and against it with respect to those instructing it to reject it. The proposal will be considered accepted or rejected based on the majority vote; (vii) the preceding provisions will also apply in case of proxies representing several holders duly admitted under Section 32 of the Bankruptcy Law and the provisions set forth in point (vi) will be applicable to the voting regime; (viii) in all cases, the judge may order specific measures to ensure the participation of the creditors and the legality of the voting procedure; and (ix) when calculating the votes related to the proposal in the meeting of

holders all the positive votes are deemed to be in favor of the proposal and all the negative votes are deemed to be against the proposal.

In addition, noteholders not present at the meeting in person or by proxy or abstaining from voting will not be considered when calculating the required majority. As a consequence of the mechanism by which the majority is calculated, in the event of a restructuring of our indebtedness, the negotiation power of the noteholders may be reduced as compared to other creditors.

***Judgments of Argentine courts enforcing obligations denominated in foreign currency may order payment in Argentine pesos.***

If proceedings were brought in the courts of Argentina seeking to enforce our obligations under the Notes, these obligations may be payable in Argentine pesos in an amount equal to the amount of Argentine pesos required to settle the obligation denominated in foreign currency under the agreed terms and subject to applicable law or, alternatively, according to the exchange rate between the Argentine peso and the U.S. dollar in force at the time of payment. We cannot assure you that such rates of exchange will afford investors full compensation of the amount invested in the Notes plus accrued interest.

***Variations in interest rates and exchange rate on our current and/or future financing arrangements may result in significant increases in our borrowing costs.***

Under our financing arrangements, we are permitted to borrow funds to finance the purchase of assets, incur capital expenditures, repay other obligations and finance working capital. As of March 31, 2019, a significant part of our financial debt is sensitive to changes in local interest rates. Consequently, substantial variations in interest rates could result in significant changes in the amount required to cover our debt service obligations and in our interest expense, thus affecting our results and financial condition. In addition, interest and principal amounts payable pursuant to debt obligations denominated in currencies other than Argentine pesos are subject to variations in the Argentine peso/U.S. dollar exchange rate that could result in a significant increase in the amount of the interest and principal payments in respect of such debt obligations that the Company must pay.

***Future exchange controls and restrictions on transfers abroad may impair your ability to receive payments on the Notes or repatriate your investment in the Notes.***

In 2001 and 2002 Argentina imposed exchange controls and transfer restrictions, substantially limiting the ability of companies to retain foreign currency or make payments abroad. In addition, new regulations were issued in the last quarter of 2011, which significantly curtailed access to the foreign exchange market by individuals and private sector entities. More recently, since December 2015 the new administration has lifted many of the foreign exchange restrictions imposed in 2011. In August 2016, the Central Bank issued new regulations which repealed most of the restrictions for the purchase of foreign currency and the inflow and outflow of funds from Argentina. As a consequence, non-resident investors that acquire the Notes in the Argentine markets with dollars exchanged for pesos at the official foreign exchange market have access to the MELI for transferring the proceeds resulting from the sale of the Notes abroad irrespective of the amount involved and without the prior approval of the Central Bank, provided that (i) such investment has been settled through the MELI and has remained in Argentina for a minimum term of 120 calendar days and (ii) the foreign beneficiary is either a natural or legal person residing in or incorporated and established in a jurisdiction, territory or associated state that is considered a “cooperator for the purposes of fiscal transparency.”

Argentina may impose new stricter exchange controls and transfer restrictions in the future, among other things, in response to capital flight or a significant depreciation of the peso. In such event, our ability to make payments abroad may be affected and therefore your ability to receive payments on the Notes may be impaired.

***Publicly available information about public companies in Argentina is generally less detailed and not as frequently updated as the information that is regularly published by or about listed companies in the United States.***

Publicly available information on the issuers of securities registered with the CNV, such as us, provides less detail in certain respects than the information that is regularly published by or about listed companies in the United States and certain other countries. In addition, regulations governing the Argentine securities market are not as extensive as those in effect in the United States and other major world markets. As a result, there may be less publicly available information about Argentine companies than is regularly published by or about companies in the United States and certain other countries.

***There is uncertainty in respect of the tax treatment of the Notes for holders in certain jurisdictions.***

Argentina has recently introduced a comprehensive tax reform that tax payments to certain “non-cooperative” jurisdictions under financial instruments such as the Notes. There is uncertainty as to the scope of these changes and as to which jurisdictions are considered “non-cooperative” by the Argentine tax authorities. Payments of interest to holders of the Notes resident in those jurisdictions will be subject to a 35% withholding tax, and we will not gross those holders up in such circumstances. For more information, please see “See “Taxation—Certain Argentine Tax Considerations—Income Tax” and “Description of the Notes—Payments of Additional Amounts.” As a result of this uncertainty, the Notes could face reduced liquidity, which could adversely affect the market price and marketability of the Notes.

## EXCHANGE RATES AND EXCHANGE CONTROLS

### Exchange Rates

From April 1, 1991 until the end of 2001, the Convertibility Law (*Ley de Convertibilidad*) (Law No. 23,928) established a fixed exchange rate under which the Central Bank was obligated to sell U.S. dollars at one peso per U.S. dollar. On January 6, 2002, the Argentine Congress enacted Law No. 25,561, the Public Emergency Law and Reform of the Exchange Rate Regime (referred hereinafter as the “Public Emergency Law”), formally putting an end to the Convertibility Law regime and abandoning over 10 years of U.S. dollar-peso parity. The Public Emergency Law, which was extended until December 31, 2017 by Law No. 27,200, granted the executive branch of the Argentine government the power to set the exchange rate between the peso and foreign currencies and to issue regulations related to the Argentine foreign exchange market. Following a brief period during which the Argentine government established a temporary dual exchange rate system pursuant to the Public Emergency Law, the peso has been allowed to float freely against other currencies since February 2002, although the government has the power to intervene by buying and selling foreign currency for its own account, a practice in which it engages on a regular basis.

The following table sets forth the annual high, low, average and period-end exchange rates for U.S. dollars for the periods indicated, expressed in nominal pesos per U.S. dollar, based on rates quoted by the Central Bank. The Federal Reserve Bank of New York does not report a noon buying rate for Argentine pesos.

<b>Year ended December 31,</b>	<b>Low</b>	<b>High</b>	<b>Average<sup>(1)</sup></b>	<b>Period End</b>
	<b>(pesos per U.S. dollar)</b>			
2012.....	4.30	4.92	4.58	4.92
2013 <sup>(2)</sup> .....	4.92	6.52	5.54	6.52
2014 <sup>(2)</sup> .....	6.54	8.56	8.23	8.55
2015 <sup>(2)</sup> .....	8.73	13.76	9.39	13.01
2016.....	13.07	16.04	14.78	15.85
2017.....	15.17	18.83	16.76	18.77
2018.....	18.42	40.90	28.09	37.81
<b>Month</b>				
January 2019 .....	37.04	37.93	37.41	37.04
February 2019 .....	37.20	40.04	38.41	39.00
March 2019 .....	39.45	43.70	41.36	43.35
April 2019 .....	41.56	45.63	43.23	44.01
May 2019 .....	44.42	45.57	44.93	44.87
June 2019 .....	42.31	44.98	43.79	42.45
July 2019 (through July 16).....	41.66	42.63	42.02	42.63

(1) Represents the average of the exchange rates on the last day of each month during the period.

(2) Foreign exchange controls existed during the 2013-2015 period.

Source: Reference exchange rate of the Central Bank as shown in Communication “A” 3500 (Tipo de Cambio de Referencia Comunicación “A” 3500 (Mayorista)).

No representation is made that peso amounts have been, could have been or could be converted into U.S. dollars at the foregoing rates on any of the dates indicated.

### Foreign Exchange Regulations

In January 2002, upon enactment of Law No. 25,561, the state of public emergency was declared in terms of social, economic, administrative, financial and exchange conditions, and the Argentine executive branch was vested with the power to establish a system to determine the exchange rate between the peso and foreign currencies, and to enact foreign exchange regulations. In such context, on February 8, 2002, the Argentine executive branch passed Decree 260/2002 which established (i) the MULC where all foreign exchange transactions were to be settled, and (ii)

that foreign exchange transactions are to be consummated at an exchange rate that is agreed freely, subject to the requirements and regulations imposed by the Argentine Central Bank (below is a detail of their main aspects).

On June 9, 2005, by means of Decree No. 616/2005, the Argentine government established that (a) all inflows of funds into the domestic foreign exchange market arising from foreign debts incurred by individuals or entities of the private sector, excluding foreign trade financing and primary issuances of debt securities admitted to public offering and authorized to be listed and/or traded on self-regulatory markets; and (b) all inflows of funds of non-residents channeled through the local foreign exchange market to be applied to: holdings of local currency, acquisition of all types of financial assets or liabilities in the financial or non-financial private sector, to the exclusion of direct foreign investment and primary issuances of debt securities and shares admitted to public offering and authorized to be listed and/or traded in self-regulatory markets, and investments in government securities acquired in secondary markets must meet the following requirements: (i) the funds entering the country may only be transferred out of the local foreign exchange market at the expiration of a term of 365 calendar days counted as from the date the funds were received in Argentina; (ii) the proceeds of the foreign exchange settlement of the funds received in Argentina must be credited to an account in the local banking system; (iii) a registered, non-transferable and non-interest bearing deposit equivalent to 30% of the amount involved in the relevant transaction is to be maintained for a term of 365 calendar days in the conditions prescribed by the regulations (the “Mandatory Deposit”); and (iv) the Mandatory Deposit is to be made in U.S. dollars and held in a financial institution in Argentina. It shall not accrue interest nor any other type of benefits and it shall not be used to secure credit facilities of any type.

On December 18, 2015, Resolution No. 3/2015 issued by the Ministry of Economy and Public Finances reduced the Mandatory Deposit percentage created by Decree No. 616/2005 from 30% to 0% and changed the mandatory minimum stay period of funds in the country to 120 calendar days as of the inflow date of such amount (the “Mandatory Minimum Stay Period”). On January 5, 2017, Resolution No. 1-E/2017 of the Ministry of Treasury further reduced the Mandatory Minimum Stay Period to zero days.

In accordance with Communication “A” 6436, with effect as from January 20, 2018, all of the rules previously regulating foreign exchange transactions were removed (unless otherwise indicated), and replaced by the following rules and regulations:

- Any individual or entity is able to freely trade through the MELI.
- All foreign exchange transactions must be conducted through an authorized financial entity.
- The hours of operation restrictions for the foreign exchange market were removed.
- The obligation of Argentine residents to comply with the survey of foreign assets and liabilities even if there was no inflow of funds to the MELI and/or no future access to it for transactions to be declared.
- The obligation to execute foreign exchange tickets for each foreign exchange transaction was removed; *provided, however* that registration of all transactions by the intervening financial entity remains in effect.
- Financial entities shall comply with prevention of anti-money laundering and financing of terrorism rules.
- Exchange transactions shall be made at an exchange rate freely agreed between the parties.

Failure to comply with the requirements established by the Central Bank to access the local exchange market for transactions involving the purchase and sale of securities of all types constitute an infraction subject to the criminal exchange regime.

### *Survey of foreign assets and liabilities*

On December 28, 2017, through Communication “A” 6401 as supplemented by Communication “B” 11712, the Central Bank implemented a unified reporting regime applicable as of December 31, 2017. The reporting requirements under the information regime vary depending upon the final balance or amount of foreign assets and liabilities:

- For individuals or entities for whom the balance or the acquisition or sale of external assets and liabilities at the end of a given calendar year are equal to or exceed the equivalent of US\$50,000,000, a quarterly declaration prior to the end of each quarter and an annual declaration, which permits the correction, affirmation or update of quarterly declarations, must be filed.
- For individuals or entities for whom the balance or the acquisition or sale of external assets and liabilities at the end of a given calendar year are equal to or greater than US\$10 million, but less than US\$50 million, only an annual declaration is required.
- For individuals or entities for whom the balance or the acquisition or sale of external assets and liabilities at the end of a given calendar year are equal to or greater than US\$1 million but less than US\$10 million, only a simplified annual declaration is required.

There is no reporting obligation for individuals or entities for whom the balance or the acquisition or sale of foreign assets and liabilities at the end of a given calendar year are less than US\$1 million.

For further information regarding all the current foreign exchange restrictions and control regulations, investors should seek advice from their legal advisors and read the applicable rules mentioned herein, as well as its amendments and complementary regulations, which are available at the website: <http://www.infoleg.gob.ar/>, or the Central Bank’s website: [www.bcra.gov.ar](http://www.bcra.gov.ar), as applicable. None of the information on or connected to such websites is incorporated by reference into this offering memorandum.

## USE OF PROCEEDS

We estimate that the gross proceeds from the sale of the Notes will be approximately US\$395,088,000, before deducting the initial purchasers' discount and estimated offering expenses.

We intend to use the net proceeds from the sale of the Notes in accordance with the requirements of Section 36 of the Argentine Negotiable Obligations Law and other applicable laws and regulations in effect in Argentina as follows:

- for working capital purposes in Argentina;
- investments in physical assets and tangible assets in Argentina;
- payment of capital contributions in subsidiaries of the Company, acquisition of equity interests and/or providing financing to our subsidiaries in the ordinary course of business, which proceeds are applied to the uses mentioned above; and
- refinancing of indebtedness.

Pending application, the proceeds may be invested in short-term investments.

For more information on our indebtedness, see "Management's Discussion and Analysis of Financial Condition and Results of Operations—Liquidity and Capital Resources—Indebtedness."



## CAPITALIZATION

The table below sets forth our current debt, non-current debt and capitalization as of March 31, 2019, (i) on an actual basis and (ii) as adjusted to give effect to this offering. See “Use of Proceeds” and “Management’s Discussion and Analysis of Financial Condition and Results of Operations — Liquidity and Capital Resources — Bank and Financial Debt.”

This information should be read in conjunction with our Financial Statements included elsewhere in this offering memorandum and with the information under “Presentation of Financial and Other Information.”

	As of March 31, 2019	
	Actual	As adjusted
	(In thousand of Ps.)	
<b>Current debt</b>		
Financial loans .....	6,809,814	6,809,814
Leases liabilities .....	100,748	100,748
<b>Total current debt .....</b>	<b>6,910,562</b>	<b>6,910,562</b>
<b>Non-current debt .....</b>		
Leases liabilities .....	358,553	358,553
Financial loans .....	20,943,971	20,943,971
Notes offered hereby(*) .....	-	17,127,065
<b>Total non-current debt .....</b>	<b>21,302,524</b>	<b>38,429,589</b>
<b>Total current and non-current debt .....</b>	<b>28,213,086</b>	<b>45,340,151</b>
<b>Total shareholders’ equity .....</b>	<b>30,546,198</b>	<b>30,546,198</b>
<b>Total capitalization .....</b>	<b>58,759,284</b>	<b>75,886,349</b>

(\*) the US\$395,088,000 of gross proceeds for the issuance of the Notes have been translated into pesos using the exchange rate of Ps. 43.35 as of March 31, 2019 reference exchange rate of the Central Bank as shown in Communication “A” 3500 (*Tipo de Cambio de Referencia Comunicación “A” 3500 (Mayorista)*)

On May 10, 2019 and June 12, 2019, under the terms of the Program, we issued the “2021 Notes”. Under the terms of the 2021 Notes, we will make quarterly interest payments in arrears on each interest payment date starting on August 10, 2019. The notes mature on May 10, 2021.

Except as described above, there have been no material changes to our capitalization since March 31, 2019.

## SELECTED FINANCIAL DATA

The following tables present selected financial data as of March 31, 2019 and for the three-month periods ended March 31, 2019 and 2018, which is derived from our Unaudited Interim Financial Statements, and selected financial data as of December 31, 2018 and 2017 and January 1, 2017 and for the years ended December 31, 2018 and 2017, which financial data is derived from our Audited Annual Financial Statements. The selected financial data included herein is qualified in its entirety and should be read together with our Financial Statements as well as the sections entitled “Presentation of Financial and Other Information” and “Management’s Discussion and Analysis of Financial Condition and Results of Operations.”

Our Financial Statements were prepared on a consolidated basis in accordance with IFRS. We used a transition date of January 1, 2017 and, therefore, our Audited Annual Financial Statements as of December 31, 2018 and 2017 and January 1, 2017 and for the years ended December 31, 2018 and 2017 are our first audited annual consolidated financial statements to be prepared in accordance with IFRS. IFRS 1—First-time Adoption of International Financial Reporting Standards governs the adoption of IFRS and first-time preparation of consolidated financial statements and provides for certain exceptions and exemptions. See Note 2.5 to our Annual Financial Statements for a description of the effects of adopting IFRS. Our Unaudited Interim Financial Statements have been prepared in accordance with IAS 34.

We undertook certain significant transactions which may affect the comparability of our results of operations across the periods presented herein. Therefore, our results of operations for the year ended December 31, 2018 may not be comparable to our results of operations for the year ended December 31, 2017 and, our results of operations for the three-month period ended March 31, 2019 may not be comparable to our results of operations for the three-month period ended March 31, 2018. For a summary of those transactions, see “Presentation of Financial and Other Information” in this offering memorandum.

### Selected Financial Data

#### *Consolidated Statements of Comprehensive Income*

	For the three-month period ended March 31,		For the year ended December 31,	
	2019	2018	2018	2017
	(in thousand of Ps.)			
Revenues .....	2,691,682	644,389	7,124,905	1,470,670
Production costs .....	(892,818)	(233,720)	(2,401,625)	(443,646)
<b>Gross profit</b> .....	<b>1,798,864</b>	<b>410,669</b>	<b>4,723,280</b>	<b>1,027,024</b>
Administrative and selling expenses .....	(247,766)	(49,217)	(544,414)	(183,508)
Remeasurement of pre-existing equity interest .....	—	1,785,033	1,785,033	—
Other net operating results .....	33,838	(294)	(292)	(723)
<b>Operating profit</b> .....	<b>1,584,936</b>	<b>2,146,191</b>	<b>5,963,607</b>	<b>842,793</b>
Income from equity interest in associates .....	131,146	43,937	268,015	67,503
Finance income .....	515,756	269,750	1,285,441	208,769
Finance loss .....	(917,487)	(442,893)	(2,607,963)	(197,190)
Net financial results .....	(401,731)	(173,143)	(1,322,522)	11,579
<b>Profit before income tax from continuing operations</b> .....	<b>1,314,351</b>	<b>2,016,985</b>	<b>4,909,100</b>	<b>921,875</b>
Income tax .....	(197,080)	(113,147)	(416,984)	(269,105)
<b>Net profit for the period/year from continuing operations</b> .....	<b>1,117,271</b>	<b>1,903,838</b>	<b>4,492,116</b>	<b>652,770</b>
Profit after income tax for the period/year from discontinued operations .....	—	13,296	13,296	193,987
<b>Net profit for the period/year</b> .....	<b>1,117,271</b>	<b>1,917,134</b>	<b>4,505,412</b>	<b>846,757</b>
<b>Other comprehensive income for the period/year</b>				
Items that may be reclassified to net profit in subsequent periods				
Fair value changes on derivative instruments .....	(26,173)	24,810	26,391	-
Items that may not be reclassified to net profit in subsequent periods				
Translation differences .....	3,933,824	332,988	11,170,660	542,191

	For the three-month period ended March 31,		For the year ended December 31,	
	2019	2018	2018	2017
	(in thousand of Ps.)			
Net variation of other comprehensive income for the period/year .....	3,907,651	357,798	11,197,051	542,191
<b>Total Comprehensive income for the period/year..</b>	<b>5,024,922</b>	<b>2,274,932</b>	<b>15,702,463</b>	<b>1,388,948</b>
<b>Net profit for the period/year attributable to shareholders</b>				
Continuing operations.....	1,117,271	1,917,134	4,505,412	846,757
Discontinued operations .....	—	13,296	13,296	193,987
<b>Total comprehensive income for the period/year attributable to shareholders.....</b>	<b>5,024,922</b>	<b>2,274,932</b>	<b>15,702,463</b>	<b>1,388,948</b>
Continuing operations.....	5,024,922	2,261,636	15,689,167	1,194,961
Discontinued operations .....	—	13,296	13,296	193,987

### Consolidated Balance Sheet Data

	As of March 31,	As of December 31,		As of January 1,
	2019	2018	2017	2017
	(in thousand of Ps.)			
<b>Assets</b>				
<b>Non-current Assets</b>				
Property, plant and equipment.....	48,503,937	37,650,465	5,234,723	1,941,058
Intangible assets .....	224,419	196,835	—	—
Right of use asset.....	527,130	—	—	—
Investments in associates and joint ventures .....	2,386,115	1,948,492	2,424,677	459,326
Other receivables .....	2,582,507	1,846,127	623,638	802,708
Investment in financial assets .....	41,571	69,901	—	—
Deferred income tax assets .....	36,029	54,153	—	—
<b>Total non-current assets .....</b>	<b>54,301,708</b>	<b>41,765,973</b>	<b>8,283,038</b>	<b>3,203,092</b>
<b>Current Assets</b>				
<b>Inventories</b>		—	585	256
Other receivables .....	1,626,910	6,234,304	255,428	212,603
Trade receivables .....	3,451,571	3,724,234	707,855	372,205
Other financials assets.....	1,750,466	1,489,031	—	—
Cash and cash equivalents .....	7,632,835	4,701,336	139,082	651,447
<b>Total current assets .....</b>	<b>14,461,782</b>	<b>16,148,905</b>	<b>1,102,950</b>	<b>1,236,511</b>
<b>Total Assets.....</b>	<b>68,763,490</b>	<b>57,914,878</b>	<b>9,385,988</b>	<b>4,439,603</b>
<b>Liabilities</b>				
<b>Non-current Liabilities</b>				
Provisions.....	38,122	35,421	91,261	63,447
Deferred income tax liability.....	2,849,236	2,430,623	347,288	157,886
Leases liabilities .....	358,553	—	—	—
Loans.....	20,943,971	18,256,570	3,088,604	1,679,560
Other liabilities .....	—	—	—	200
<b>Total non-current liabilities .....</b>	<b>24,189,882</b>	<b>20,722,614</b>	<b>3,527,153</b>	<b>1,901,093</b>
<b>Current Liabilities</b>				
Provisions	—	—	14,594	12,219
Income Tax Payable	—	—	—	42,630
Taxes payable .....	281,960	340,436	11,839	65,002
Salaries and social security.....	136,040	151,256	47,012	22,881
Leases liabilities .....	100,748	—	—	—
Loans.....	6,809,814	6,514,408	992,375	8,985
Other liabilities .....	110,610	99,359	200	—
Accounts payable .....	6,588,238	4,565,529	879,428	639,388
<b>Total current liabilities.....</b>	<b>14,027,410</b>	<b>11,670,988</b>	<b>1,945,448</b>	<b>791,105</b>
<b>Total Liabilities.....</b>	<b>38,217,292</b>	<b>32,393,602</b>	<b>5,472,601</b>	<b>2,692,198</b>
<b>Shareholders' Equity</b>				
Shareholders' contributions.....	8,411,982	8,411,982	2,506,556	58,816
Reserves, other comprehensive income and retained earnings .....	22,134,216	17,109,294	1,406,831	1,688,589
<b>Total Shareholders' Equity .....</b>	<b>30,546,198</b>	<b>25,521,276</b>	<b>3,913,387</b>	<b>1,747,405</b>

## Non-IFRS Financial Data

The following table reconciles our net profit to Adjusted EBITDA and Adjusted EBITDA margin for the periods shown:

	For the three-month period ended March 31,		For the year ended December 31,	
	2019	2018	2018	2017
	(in thousands of Ps, except percentages)		(in thousands of Ps., except percentages)	
Net profit for the period/year.....	1,117,271	1,917,134	4,505,412	846,757
Plus:				
<i>Continuing operations</i>				
Net financial results.....	401,731	173,143	1,322,522	(11,579)
Depreciation of property, plant and equipment .....	503,964	65,996	1,279,867	76,840
Depreciation of right of use of assets	31,253	-	-	-
Income tax.....	197,080	113,147	416,984	269,105
<i>Discontinued operations</i>				
Depreciation of property, plant and equipment .....	-	3,407	3,407	11,975
Income tax.....	-	2,081	2,081	96,874
<b>Adjusted EBITDA.....</b>	<b>2,251,299</b>	<b>2,274,908</b>	<b>7,530,273</b>	<b>1,289,972</b>
Continuing operations revenues .....	2,691,682	644,389	7,124,905	1,470,670
Discontinuing operations revenues	-	41,502	41,502	449,901
<b>Continuing and discontinuing operations revenues</b>	<b>2,691,682</b>	<b>685,891</b>	<b>7,166,407</b>	<b>1,920,571</b>
<b>Adjusted EBITDA margin.....</b>	<b>83.64%</b>	<b>331.67%</b>	<b>105.08%</b>	<b>67.17%</b>

Adjusted EBITDA and Adjusted EBITDA margin are not presentations made in accordance with IFRS. Adjusted EBITDA and Adjusted EBITDA margin may not be comparable to other similarly titled measures of other companies and have limitations as an analytical tool and should not be considered in isolation or as a substitute for analysis of our operating results as reported under IFRS.

## MANAGEMENT'S DISCUSSION AND ANALYSIS OF FINANCIAL CONDITION AND RESULTS OF OPERATIONS

The following discussion is based on, and should be read together with, our Financial Statements included elsewhere in this offering memorandum, as well as the information set forth in "Presentation of Financial and Other Information". This discussion includes forward-looking statements which involve risks and uncertainties, as described in "Forward-Looking Statements." You should review the Risk Factors set forth elsewhere in this offering memorandum for a discussion of important factors that could cause actual results to differ materially from the results described in or implied by the forward-looking statements contained herein.

### Overview

We are a leading Argentine power company, primarily engaged in the development and generation of electrical power from both conventional (thermal) and renewable (wind, solar and biomass) sources. As of the date of this offering memorandum, we have a total net installed capacity of 1,819 MW, including our 30.76% equity interest in the Central Dock Sud plant, which consists of a Combined Cycle turbine with an installed capacity of 797.5 MW and two Open Cycle turbines with an installed capacity of 36 MW each.

We currently have eight thermal plants and one wind farm in operation, including our equity interest in Central Dock Sud. The following table presents a brief description of our operating power plants and wind farm.

Plant	Location	Installed capacity (MW)	Regulatory Framework / Offtaker	Technology	COD	Expiration date of PPA
Tucumán Power Plant <sup>(1)</sup> .....	Province of Tucumán	447	Energía Base <sup>(6)</sup>	Combined Cycle	1996/1997	N/A
San Miguel de Tucumán Power Plant <sup>(1)</sup> .....	Province of Tucumán	382	Energía Base <sup>(6)</sup>	Combined Cycle	1995/2000	N/A
El Bracho GT <sup>(1)(2)</sup> ...	Province of Tucumán	267	PPA with CAMMESA <sup>(7)</sup>	Open Cycle	January 2018	January 26, 2028
Loma Campana I...	Province of Neuquén	105	YPF <sup>(8)</sup>	Open Cycle	November 2017	November 15, 2032
Loma Campana II..	Province of Neuquén	107	PPA with CAMMESA <sup>(7)</sup>	Open Cycle	November 2017	November 29, 2027
Loma Campana Este <sup>(3)</sup> .....	Province of Neuquén	17	YPF <sup>(8)</sup>	Motor generator	July 2017	July 11, 2020
LPC I <sup>(4)</sup> .....	Province of Buenos Aires	128	Energía Base <sup>(6)</sup>	Cogeneration	1997	N/A
Manantiales Behr...	Province of Chubut	99	PPA with YPF and other industrial clients <sup>(9)</sup>	Wind farm	July/December 2018	Several PPAs <sup>(9)</sup>
Central Dock Sud ..	Province of Buenos Aires	267 <sup>(5)</sup>	Energía Base <sup>(6)</sup>	Combined Cycle/ Open Cycle	1989/2000	N/A
<b>Total.....</b>		<b>1,819</b>				

(1) Part of the "Tucumán Complex."

(2) El Bracho ST Combined Cycle is under construction and is expected to start commercial operations in the fourth quarter of 2020. For reasons beyond our control, we may not commence commercial operations as required under the applicable PPA. See "Business—Our Projects—Thermal Energy—El Bracho ST".

(3) Not connected to the SADI.

(4) Acquired from Central Puerto S.A. in February 2018, effective as of January 5, 2018. The LPC I power plant also produces between 190 and 210 tons of steam per hour, which are sold to YPF.

- (5) *Represents our 30.76% indirect equity interest in CDS, a power plant located in the Province of Buenos Aires and operated by Enel S.A., with an installed capacity of 797.5 MW of Combined Cycle turbines and 72 MW of installed capacity for two Open Cycle turbines (36 MW each).*
- (6) *Resolution No. 1/2019.*
- (7) *Resolution No. 21/2016.*
- (8) *Self-generation.*
- (9) *The generation under this wind farm is committed under nine PPAs with the private sector. The terms of such PPAs are from 5 to 21 years with a weighted average term of 11.5 years.*

## **Presentation of Financial Information**

We prepare our Consolidated Financial Statements in accordance with IFRS, as issued by the IASB. For more information, see Note 2.a to our Unaudited Interim Financial Statements and Note 2.2.1. to our Audited Annual Financial Statements.

## **Comparability of Historical Financial Information**

During 2017 and 2018, we undertook significant transactions that are described below. Consequently, due to such transactions, our results of operations and financial condition as of and for the year ended December 31, 2018 may not be comparable to our results of operations and financial conditions as of and for the year ended December 31, 2017, and our results of operations for the three-month period ended March 31, 2019 may not be comparable to our results of operations for the three-month period ended March 31, 2018.

The significant transactions that affect the comparability across those periods are the following:

- acquisition of a 42.86% equity interest in Inversora Dock Sud, which holds a 71.78% equity interest in CDS and a 9.64% equity interest in CDS from YPF on May 26, 2017;
- acquisition of certain assets related to LPC I from Central Puerto S.A. in February 2018, effective as of January 5, 2018, which we use to sell electricity to CAMMESA under Energía Base and steam to YPF under a 15 year PPA;
- sale of our 27.00% interest in the Ramos Area to YPF effective as of February 2, 2018, which has been reflected as a discontinued operation in our Financial Statements;
- sale of our 9.64% equity interest in CDS to YPF, effective as of March 1, 2018;
- acquisition of the remaining 33.33% interest in Y-GEN and Y-GEN II from General Electric in connection with General Electric's acquisition of 24.99% of our equity effective as of March 20, 2018, which we consolidate on a line by line basis in our balance sheet since March 31, 2018 and in our income statements and cash flow beginning April 2018, in each case, together with the 66.67% of Y-GEN and Y-GEN II that we owned prior to such acquisition;
- changes in the remuneration paid by CAMMESA to us under Energía Base, effective in February 2017 and March 2019, in relation to our Tucumán Power Plant, San Miguel de Tucumán Power Plant, LPC I (which we acquired in February 2018, effective as of January 5, 2018) and Central Dock Sud power plants, which collectively represent 67.3% of our installed capacity; and
- our Loma Campana Este, Loma Campana I, Loma Campana II, El Bracho GT, Manantiales Behr (phase I and phase II) power plants entered into commercial operation in July 2017, November 2017, November 2017, January 2018 and July 2018 (phase I) and December 2018 (phase II), respectively, which collectively represent 32.7% of our installed capacity.

## Factors Affecting our Operations

Our results of operations have been affected and will continue to be affected by numerous factors, including the factors described in this section. Our business is inherently volatile due to the influence of external factors, such as domestic demand, market prices, available financing for our projects and its associated costs, and governmental regulations. Therefore, our past financial position, results of operations and their respective trends may not be indicative of our current financial position, results of operations or trends in future years. See also, “Argentine Electricity Industry and Regulatory Framework.”

According to our business plan, we will remain focused on increasing our generation capacity through investments in new generation projects that are under construction and on the enhanced efficiency of our existing assets in 2019. The demand for power is expected to continue to rise in the Argentine market, and is expected to increase when economic activity grows. In turn, we need to increase our capital expenditures in order to be more efficient, as the power supply in Argentina is expected to be increasingly competitive in terms of prices and availability in the coming years.

Notwithstanding the foregoing, there can be no assurances that our production costs, prices or our estimates of cash flows from operating activities, among other factors, could not be affected by factors beyond our control. See “Risk Factors” in this offering memorandum.

### *Argentine Macroeconomic Conditions*

As substantially all of our operations, facilities and customers are located in Argentina, we are affected by macroeconomic conditions in the country, including changes in economic, political and regulatory conditions, such as inflation and fluctuations in foreign exchange rates. The volatility in the Argentine economy and the measures taken by the Argentine government have had, and are expected to continue to have, a significant impact on our business. See “Risk Factors—Risks Relating to Argentina—Our business is largely dependent upon economic conditions in Argentina.”

Mauricio Macri was elected president as a result of the presidential and legislative elections, and took office on December 10, 2015. The Macri administration has faced, and continues to face, remarkable macroeconomic challenges, including, without limitation, improving the local industry competitiveness through the several variables that affect it, and the adjustment of prices for certain goods and services (such as electricity and natural gas for certain residential sectors of Argentina). Some of the measures required to achieve the aforementioned goals were, and still are, unpopular and have caused, and could continue to cause, political and social opposition. Against this backdrop, we cannot predict the impact that the measures that the Macri administration has adopted so far, such as the elimination of exchange restrictions, the partial adjustments to gas and electricity tariffs, and the liberalization of oil and fuel prices, or the additional measures it may adopt in the future, may have on the Argentine economy as a whole and the energy sector, in particular, including, for instance, the effects of such measures on inflation and the exchange rate. The existing uncertainty as to the economic measures the Macri administration will have to adopt may also result in volatility in the market prices for Argentine companies’ securities, including, in particular, energy companies, such as us, due to the high level of regulation and government intervention inherent to the sector.

In addition, Argentina’s national elections for president and vice-president and other governmental offices will take place in October 2019. The impact that such electoral process may have, including with respect to the energy industry, is uncertain. We cannot predict the measures that may be adopted by a new Macri administration or a new administration at the federal or local level, or the impact that such measures may have on the energy industry, including us.

The following table sets forth key economic indicators in Argentina during the periods indicated:

	<u>2018</u>	<u>2017</u>	<u>2016</u>	<u>2015</u>	<u>2014</u>	<u>2013</u>	<u>2012</u>
<b>Economic Activity</b>							

	2018	2017	2016	2015	2014	2013	2012
Real GDP (pesos of 2004) (% change) as % of GDP <sup>(1)</sup>	(2.5)%	2.7%	(2.1)%	2.7%	(2.5)%	2.4%	(1.0)%
Real GDP (in billions of pesos of 2004) <sup>(1)</sup>	707,092	725,331	706,478	721,487	702,306	720,407	703,486
Real gross domestic investment (pesos of 2004) (% change) as % of GDP <sup>(1)</sup>	N/A	13.9%	(5.1)%	(3.8)%	(6.8)%	2.3%	(7.1)%
<b>Price indexes and exchange rate information</b>							
Consumer Price Index (INDEC CPI) (% change)	47.6%	24.8%	-% <sup>(2)</sup>	28.5% <sup>(2)</sup>	24.0%	10.9%	10.8%
Inflation (as measured by the City of Buenos Aires CPI) (% change) <sup>(3)</sup>	45.5%	26.1%	41.0%	26.9%	38.0%	26.6%	N/A
Inflation (as measured by the Province of San Luis CPI) (% change) <sup>(4)</sup>	50.0%	24.3%	31.4%	31.6%	39.0%	31.9%	23.0%
Wholesale Price Index (WPI) (% change)	73.5%	18.8%	34.5% <sup>(3)</sup>	10.6% <sup>(3)</sup>	28.3%	14.7%	13.1%
Nominal Exchange Rate <sup>(5)</sup> (in Ps./US\$ at fiscal year-end)	37.808	18.774	15.310	13.005	8.552	6.518	4.917

Sources: Argentine Ministry of Economy, Central Bank and INDEC.

(1) Information provided by INDEC.

(2) On January 8, 2016, based on its determination that the INDEC had failed to produce reliable statistical information, including with respect to CPI, the Macri administration declared the INDEC in a state of administrative emergency until December 31, 2016. The INDEC implemented certain methodological reforms and adjusted certain macroeconomic statistics on the basis of these reforms. During the first six months of this reorganization period, the INDEC published official CPI figures published by the City of Buenos Aires and the province of San Luis for reference, which we include herein. In June 2016, the INDEC resumed publishing CPI beginning with the months of May 2016.

(3) Information provided by the General Office of Statistics and Census (Dirección General de Estadística y Censos) of the City of Buenos Aires.

(4) Information provided by the General Office of Statistics and Census of the Province of San Luis.

(5) Wholesale reference exchange rates quoted by the Central Bank (Communication "A" 3500 of Central Bank).

## Inflation

Argentina has confronted and continues to confront inflationary pressures. According to inflation data published by INDEC, from 2008 to 2013, the Argentine CPI increased 7.2%, 7.7%, 10.9%, 9.5%, 10.8% and 10.9%, respectively, and the wholesale price index increased 8.8%, 10.3%, 14.5%, 12.7%, 13.1% and 14.7%, respectively. In 2014, the INDEC established a new consumer price index known as the IPCNU that more broadly reflects consumer prices by considering price information from the 24 provinces of the country, divided into six regions. According to INDEC, the IPCNU increased 23.9% in 2014. In 2015, the Macri administration of INDEC published an alternative CPI that showed an increase of 26.9%. In 2016, the alternative CPI, from January to April, increased 4.1%, 4.0%, 3.3% and 6.5%, respectively, and from May to December, a new CPI was published that showed increases of 4.2%, 3.1%, 2.0%, 0.2%, 1.1%, 2.4%, 1.6% and 1.2% respectively. In 2017, the CPI increased 24.8%. In 2018, the CPI increased 47.6%. From January through May 2019, inflation remained at high levels, and the CPI increased on a monthly basis by 2.9%, 3.8%, 4.7%, 3.4% and 3.1%, respectively.

The wholesale price index increased 10.6%, 34.5%, 18.8% and 73.5% in 2015, 2016, 2017 and 2018, respectively. From January to May 2019, the wholesale price index increased by 0.6%, 3.4%, 4.1%, 4.6% and 4.9%, respectively. Before the Macri administration took office, certain private sector analysts believed that inflation was significantly higher than the rate published by INDEC.



Inflation in Argentina has had a significant impact on our results of operations. In particular, inflation typically adversely impacts, unless offset by the depreciation of the Argentine peso, our construction costs and our cost of sales and administrative expenses, in particular our payroll and social security charges.

#### *Exchange Rate Fluctuation*

Substantially all of the tariffs we received under Energía Base and the rates under our PPAs are denominated in U.S. dollars and payable in pesos primarily at the wholesale reference exchange rate (*tipo de cambio de referencia mayorista*) quoted by the Central Bank, corresponding to the day immediately before the payment date.

Under the PPAs with CAMMESA, the U.S. dollar denominated rates are converted into pesos on the billing date rather than the date of actual payment. If there is a devaluation of the peso during the period between the 42<sup>nd</sup> day after the billing date and the actual payment date, a debit note is issued by CAMMESA for such difference.

Our results of operations have been affected and will continue to be affected by the fluctuation of the Argentine peso/U.S. dollar exchange rate. The devaluation of the peso typically results in lower costs in U.S. dollars; however, the effect may be offset by increased inflation in Argentina. In addition, our functional currency is the U.S. dollar, as defined by our board of directors, but our financial statements are presented in pesos as required by the CNV Rules. Therefore, a variation of the peso with respect to the U.S. dollar may affect our results of operations as measured in pesos.

#### *Electricity Demand and Supply*

According to Bloomberg, projected global demand is expected to increase 40% between 2016 and 2040. Specifically, demand in non-OECD (Organisation for Economic Co-operation and Development) countries is expected to almost double by 2050 due to strong consumption growth and increased electrification fueled by more than US\$10 trillion of expected power generation investments between 2016 and 2040.

Demand for electricity depends in Argentina, to a large extent, on the prevailing macroeconomic conditions and on seasonal factors. In general terms, demand for prevailing electricity varies depending on developments in the Argentine economy, as individuals and businesses generally consume more electricity in times of economic stability or growth. Therefore, demand for electricity is affected by the economic measures adopted by the Argentine government, including, without limitation, those concerning exchange rates, inflation, interest rates, prices controls, taxes, and utility tariffs.

Since the 2001-2002 economic crisis, the demand for electricity in Argentina experienced sustained growth year after year, driven by the economic upturn and tariff freezing. In 2018, demand for electricity increased by 0.3% compared to 2017, from 132,530 GWh to 132,925 GWh. However, due to the increases in tariffs and the economic recession of the last few months of 2018 the demand for energy in the industrial/business sector decreased by 1.3%. This decrease was offset by a 1.7% increase in demand in the same period for the residential customers.

In early 2018, Argentina beat its 2017 power capacity record, reaching 26,320 MW on February 8, 2018, without generation shortages and with a 10% back-up margin and no imports being required. In addition, the available thermal generation system had availability to supply electricity to Brazil in periods of shortages in that country, which resulted in an export of 267 GWh during the months of September and October 2018. In 2018, Argentine generation facilities increased their installed capacity from 36.2 GW to 38.5 GW. During 2018, thermal power generation contributed 87,725 GWh, accounting for 64% of total supply. Hydroelectric power supply contributed 39,953 GWh, accounting for 29% of the total electricity supply, followed by nuclear generation, which accounted for 4.7%. In addition, there were some minor electricity imports from Brazil, Chile, Uruguay and Paraguay. Finally, renewable energy generation accounted for 2.4% of total supply (wind, photovoltaic, and small hydroelectric generators).

During 2018, hydroelectric generation rose by 0.93%, while thermal generation declined by 0.91%, compared to 2017. Nuclear generation increased by approximately 12.9% compared to 2017. In spite of the decline, thermal generation remained the major source of electricity generation, fueled mainly by natural gas and, to a lesser extent, liquid fuels (diesel and fuel oil), and also by mineral coal during winter months.

According to CAMMESA, the average electricity generation cost in 2018 was Ps. 2,117.5/MWh, an increase of 80% compared to 2017 mainly as a consequence of the depreciation of the peso during the year. In addition, the average marginal cost of operations was Ps. 2,196/MWh, accounting for a 35% increase compared to 2017. The seasonal monomial price rose from Ps. 810.1/MWh in December 2017 to Ps. 1,346.5/MWh with the last increase registered in December 2018, accounting for a 66% increase year to year.

Since the end of 2015, the former MEyM has taken measures to boost generation capacity in order to ensure the supply of electricity and reduce the need for imports from neighboring countries. Investments in generation during the last years through the different programs implemented by the former MEyM caused an increase in the installed capacity necessary to cover the demand requirements without having to resort to electricity imports from neighboring countries and, at the same time, strengthened the reserves to guarantee the reliability and security of the Argentine electrical system.

Within this context, the Argentine government ran a bidding process for new generation projects, both from conventional and renewable sources. The SEN called for bids under the Thermal Energy Program to install new thermal generation units that became operational between summer 2016/2017 and summer 2017/2018, offering generators long-term PPAs with CAMMESA denominated in U.S. dollars. In addition, in October 2015, the Argentine Congress amended the Renewable Energy Program, establishing that renewable energies should account for 8% and 20% of total demand by 2017 and 2025, respectively; ordering that certain industrial and commercial users cover a larger portion of their consumption through renewable energy sources, and granting tax and other benefits to our renewable energy projects.

### Our Revenues

Below we summarize key aspects of our most significant sources of revenue, which include our revenues derived from: (i) our PPAs, (ii) Energía Base, and (iii) steam sales. During the year ended December 31, 2018, our revenues under our PPAs, Energía Base and the sale of steam accounted for 48.4%, 45.9% and 5.4% of our revenues, respectively, and during the three-month period ended March 31, 2019, our revenues under our PPAs, Energía Base and the sale of steam accounted for 60.5%, 34.4% and 5.1% of our revenues, respectively.

Charts below show allocation of income and installed capacity by power off taker and, assuming the completion of our projects under construction by the expected COD, projections on revenue allocation by power off taker by the end of 2020.

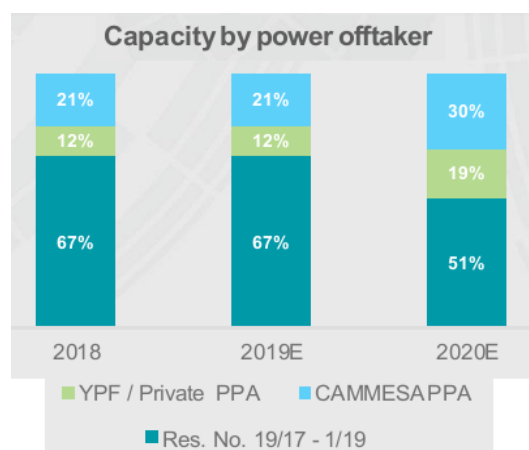

### Revenue by offtaker for the year 2018

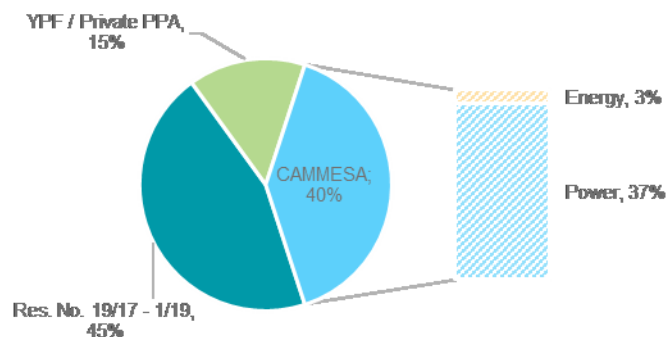

### Expected revenue by offtaker for the year 2020

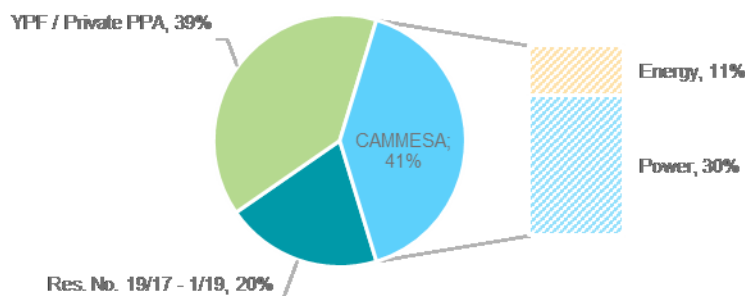

#### Our PPAs

Revenues from our four newer thermal power plants derive from U.S. dollar-denominated PPAs with CAMMESA and YPF with terms ranging from 10 to 20 years (except for the agreement for Loma Campana Este which has a term of three years). Our existing PPAs for our thermal power plants provide for payments for firm capacity based on the availability of our plants as well as electricity effectively delivered. We also have three thermal plants under construction and three wind farms under construction which revenues will derive from PPAs that we have either executed, or that we expect to enter into with large private users. The fuel needed to produce power under our PPAs is either supplied by CAMMESA or purchased from third parties subject to reimbursement but limited by the specific guaranteed consumption of the generator units installed in each plant (the “Specific Guaranteed Consumption”) as follows:

- Pursuant to the PPA related to LPC II, the Specific Guaranteed Consumption of each machine is 1,680 kcal / kWh in the case of natural gas and 1,820 kcal / kWh in the case of gas oil.
- In accordance with the PPA related to El Bracho ST, the Guaranteed Specific Consumption of each machine is 1,530 kcal / kWh in the case of natural gas (functioning as a Combined Cycle).

The fuel consumed by the generating units that exceeds the Specific Guaranteed Consumption is deducted monthly from the payments made by CAMMESA at the purchase prices established by CAMMESA.

Revenues from our Manantiales Behr wind farm derive from nine PPAs with private companies, including YPF, Profertil S.A., Coca-Cola FEMSA de Buenos Aires S.A., Toyota Argentina S.A., Nestle Argentina S.A. and Roca Argentina S.A. In addition, we have entered into PPAs with private affiliates in connection with our Los Teros I and Los Teros II wind farms, and we entered into a PPA with CAMMESA in connection with our Cañadón León wind farm. Although under PPAs for renewable energy we are compensated based on the amount of energy dispatched,

our wind farms benefit or will benefit from dispatch priority granted by CAMMESA and benefit from very favorable wind conditions and they each have an expected P50 load factor in excess of 50%. Our PPAs related to renewable energy are typically denominated in U.S. dollars.

Below are details regarding the installed capacity of each of our thermal power plants committed under long-term sale agreements:

Plant	Counterparty	Contracted Capacity	Average Price for Capacity <sup>(3)</sup>	Average Price for Electricity <sup>(3)</sup>	Type of fuel	Term (in years)	Commencement Date	Expiration Date
El Bracho GT	CAMMESA	267 MW	18,600 US\$/MW/Month	11,32 US\$/MWh	Natural gas supplied by CAMMESA <sup>(1)</sup>	10	January 27, 2018	January 26, 2028
El Bracho ST (Closing Cycle) <sup>(4)</sup>	CAMMESA	198 MW	22,200 US\$/MW/Month	5 US\$/MWh	N/A	15	Committed COD: 3 <sup>rd</sup> quarter 2020	August 23, 2035
Loma Campana I	YPF	105 MW	27 US\$/MW/Month	N/A	Natural gas supplied by YPF under a power availability and operation and maintenance agreement <sup>(2)</sup>	15	November 15, 2017	November 14, 2032
Loma Campana II	CAMMESA	107 MW	20.272 US\$/MW/Month	8,95 US\$/MWh	Natural gas supplied by CAMMESA <sup>(1)</sup>	10	November 30, 2017	November 29, 2027
Loma Campana Este	YPF	17 MW	16.51 US\$/MW-h	22.51 US\$/MWh	Natural gas supplied by YPF under a power availability and operation and maintenance agreement <sup>(2)</sup>	3	July 13, 2017	July 11, 2020
LPC II	CAMMESA	85 MW	18,600 US\$/MW/Month	8 US\$/MWh	Natural gas and gasoil to be supplied by YPF <sup>(2)</sup>	15	Committed COD: April 15, 2020	April 14, 2035
Manantiales Behr Thermal Plant	YPF	58 MW	23.33 US\$/MW-h	6.56 US\$/MWh	Natural gas provided by YPF <sup>(2)</sup>	20	Committed COD: November 26, 2020	November 25, 2040

(1) Pursuant to the terms of the PPAs, fuel is supplied by CAMMESA free of charge.

(2) Fuel is supplied by YPF free of charge.

(3) Energy average price for 2018.

(4) For circumstances beyond our control, the COD may occur after the outside date required under the applicable PPA. See “Business—El Bracho ST”.

Below are details regarding our renewable energy generation assets committed under long-term sale agreements. Our PPAs related to the Los Teros I, Los Teros II and Manantiales Behr (Phase 2) projects (except for the PPA with YPF) are not described in the table since the terms and conditions of the PPAs we entered into with private large users may vary significantly. As of the date of this offering memorandum, we had 342 MW under PPAs with private large users, including YPF.

Plant	Counterparty	Contracted Capacity	Average Price for Capacity	Average Price for Power	Load Factor	Term (in years)	Commencement Date	Expiration Date
Manantiales Behr Phase 1	YPF	49.5 MW <sup>(1)</sup>	N/A	N/A	Load Factor P50	15	August 2018	July 2033
Manantiales Behr Phase 2	YPF	29.3 MW	N/A	N/A	Load Factor P50	7	December 2018	December 2025
Cañadón León Wind Farm	CAMMESA	99 MW	N/A	41.50 US\$/MWh <sup>(1)</sup>	Load Factor P50	20	Estimated COD: 1st quarter 2020	4 <sup>th</sup> quarter 2039

(1) Awarded Price. The price payable is broken down into an Awarded Price times the Annual Adjustment Factor and the Incentive Factor as specified in the Bidding Terms and Conditions of the RenovAr2 Program.

## *Energía Base*

Energía Base accounted for 34.4%, 45.9% and 92.7% of our revenue for the three-month period ended March 31, 2019 and the years ended on December 2018 and 2017, respectively. Resolution SE No. 95/13, which was enacted in February 2013, changed the manner in which electric power was remunerated in the Spot Market and established Energía Base. Under this resolution, the applicable regulatory entity (as of the date of this offering memorandum, the Secretary of Electric Energy and in prior years the former Secretary of Electric Energy) set electric power prices that were updated annually. Under this framework, generators received remuneration consisting of (i) fixed payments based on availability and calculated based on a pre-established fixed rate per MW, (ii) variable payments based on generation of each unit calculated based on a fixed rate per MWh that varied according to the type and size of technology and the fuel used to generate energy, and (iii) remuneration for non-recurring maintenance, which was paid in the form of LVFVD. These prices were set and paid in pesos. Between 2014 and 2016, Argentine government approved certain increases to the tariff. These increases were intended to allow generators to cover, at least in part, increases in business costs resulting from inflation and the currency devaluation. However, in light of the fact that the resolutions failed to provide a pricing mechanism with a pre-established frequency, the adjustments were discretionary.

On January 27, 2017, the Secretary of Electric Energy issued Resolution No. 19/17 (published in the Official Gazette on February 2, 2017), which replaced Resolution SE No. 95/13. Pursuant to this resolution, the Secretary of Electric Energy established that electricity power generators, co-generators and self-generators acting as agents in the WEM and which operate conventional thermal power plants, may submit guaranteed availability offers (*ofertas de disponibilidad garantizada*) in the WEM. Pursuant to these offers, these generation companies committed specific capacity and power output of the generation, provided that such capacity and energy had not been otherwise committed under a PPA entered into in accordance with other remuneration schemes approved by the Argentine government. The offers had to be accepted by CAMMESA (acting on behalf of the WEM agents demanding electric power), which was the purchaser of the power under the guaranteed availability agreements (*compromisos de disponibilidad garantizada*). Resolution No. 19/17 established that such agreements could be assigned to electricity distribution companies and large users of the WEM once the state of emergency of the electric power sector in Argentina had ended.

Pursuant to Resolution No. 19/17, the remuneration was calculated in U.S. dollars and consisted of (a) fixed payments based on availability and calculated based on a pre-established fixed rate per MW, (b) variable payments based on generation of each unit calculated based on a fixed rate per MWh that varied according to the type and size of technology and the fuel used to generate energy and (c) remuneration for certain maintenance costs. Under Resolution No. 19/17 prices were set in U.S. dollars and paid in pesos at the exchange rate as of the expiration date. These prices did not include the cost of fuel since the fuel was provided by CAMMESA free of charge.

In February 2019 (effective March 1, 2019), the Argentine government enacted Resolution No. 1/2019 that replaced Resolution No. 19/17 and established a new remuneration scheme for Energía Base. Under this new scheme, the power made available by a thermal qualified generator is remunerated based on (a) a monthly payment based on available power, (b) another payment for generated power and operated power, which includes a minimum price associated with the real available power of such thermal generation unit and a price per guaranteed power provided that a certain amount of guaranteed offered power is met, and (c) remuneration for certain maintenance costs. In addition, items (a) and (b) are adjusted based on periods of high and low demand for electricity: (a) summer period (December–February), (b) winter period (June–August), and (c) the remaining periods (March–May and September–November). For more information, see “The Argentine Electric Power Sector.”

These prices do not include the cost of fuel since, under Resolution No. 1/2019, each of the thermal generators may choose to receive the fuel from CAMMESA free of charge or purchase the fuel by themselves but the cost of such fuel is reimbursed by CAMMESA.

### ***Generation Capacity Expansion***

We currently have seven operating thermal power plants and a wind farm with a combined installed capacity of 1,819 MW. In addition, we have three thermal power plants with a combined installed capacity of 341 MW under construction which we expect will be commercially operational between the second and fourth quarter of 2020 and

three wind farms with a combined installed capacity of 293 MW under construction, which we expect will be commercially operational in 2020.

The following table shows key information about our projects under construction.

<b>Power Plants</b>	<b>Location</b>	<b>Installed capacity (MW)</b>	<b>Technology</b>	<b>Expected COD</b>
El Bracho ST <sup>(1)(2)</sup> .....	Province of Tucumán	198 MW	Closed cycle	4th quarter 2020
LPC II.....	Province of Buenos Aires	85 MW	Cogeneration	2nd quarter 2020
Manantiales Behr Thermal Plant.....	Province of Chubut	58 MW	Motor generator	4th quarter of 2020
Cañadón León.....	Province of Santa Cruz	120 MW	Wind	3rd quarter 2020
Los Teros I.....	Province of Buenos Aires	123 MW	Wind	1st quarter 2020
Los Teros II.....	Province of Buenos Aires	50 MW	Wind	4th quarter 2020

(1) Part of the “Tucumán Complex.”

(2) Conversion of our existing El Bracho GT power plant from an Open Cycle into a Combined Cycle plant, increasing its installed capacity by 198 MW. For circumstances beyond our control, the COD may occur after the outside date required under the applicable PPA. See “Business—El Bracho ST”.

### **Availability and Dispatch**

Substantially all of our revenues from our thermal power plants are derived from selling firm capacity and electricity effectively delivered. However, the compensation we receive from electricity effectively delivered from our thermal power plants is principally to cover operating costs. As a result, in our power generation from conventional sources segment, our revenue is mainly driven by the availability factor of our thermal power plants.

The table below shows the availability factor for our thermal power plants and our wind farm.

	<b>Three-month period ended March 31, 2019</b>	<b>Year ended December 31,</b>	
		<b>2018</b>	<b>2017</b>
Tucumán Power Plant.....	101%	99%	87%
San Miguel de Tucumán Power Plant.....	101%	97%	89%
El Bracho GT <sup>(1)</sup> .....	98%	97%	-
Loma Campana I <sup>(2)</sup> .....	94%	59%	32%
Loma Campana II <sup>(3)</sup> .....	100%	86%	56%
Loma Campana Este <sup>(4)</sup> .....	100%	100%	98%
LPC I <sup>(5)</sup> .....	95%	96%	-
Manantiales Behr Wind Farm <sup>(6)</sup> .....	100%	96%	-
Central Dock Sud <sup>(7)</sup> .....	83%	71%	87%

(1) El Bracho GT began commercial operation in January 2018.

(2) Loma Campana I began commercial operation in November 2017.

(3) Loma Campana II began commercial operation in November 2017.

(4) Loma Campana Este began commercial operation in July 2017.

(5) We acquired the LPC I power plant from Central Puerto S.A. in February 2018, effective as of January 5, 2018.

(6) Began partial commercial operation in July 2018 and final commercial operation in December 2018.

(7) We indirectly hold a 30.76% indirect equity interest in CDS, a power plant located in the Province of Buenos Aires and operated by Enel S.A., with an installed capacity of 797.5 MW of Combined Cycle turbines and 72 MW of installed capacity for two Open Cycle turbines (36 MW each).

### **Weather Conditions Affect our Wind Farms**

Although we have an operating wind farm and three wind power projects under construction, we mainly generate electricity primarily from thermal sources. Our Manantiales Behr wind farm began partial commercial operation in July 2018 and final commercial operation in December 2018. This wind farm has a nominal capacity of 99 MW. In addition, we are constructing the Cañadón León, Los Teros I and Los Teros II wind farm projects with 120 MW, 123 MW and 50 MW, respectively, which will be connected to the SADI. Therefore, the capacity to generate

and deliver electricity from these wind farms depends and will depend on weather conditions which are beyond our control, particularly, wind speeds. For more information on the impact of wind speed and risks associated with weather conditions, see “Risk Factors – Risks related to the electricity sector – Our capacity to operate wind farms on a cost-efficient basis depends, to a large extent, on the presence of suitable winds and other weather conditions.”

### **Critical Accounting Policies**

Our Financial Statements have been prepared in accordance with IFRS. Our consolidated financial statements for the fiscal year ended December 31, 2018 are the first financial statements we prepared under IFRS. For our critical accounting policies under IFRS, see Note 2 to our Audited Annual Financial Statements.

We have determined the effects of changes in professional accounting standards (“NCP” for its acronym in Spanish) applied until the closing of the previous fiscal year ended December 31, 2017. These effects have been recorded in accordance with IFRS 1 (First time adoption of IFRS) on a retroactive basis, modifying the measurement and presentation of assets and liabilities accounted for as of January 1, 2017 (our transition date to IFRS), as well as the measurement and presentation of assets and liabilities accounted for as of December 31, 2017 and the consolidated comprehensive income for the fiscal year ended on that date. However, IFRS 1 requires, in certain cases, not to change the book balances on a retroactive basis, and allows, in other expressly mentioned cases, to opt for such treatment as an alternative criterion. The effects of these changes are presented in our Audited Annual Financial Statements.

The preparation of our consolidated financial statements requires that management make judgments, estimates and significant accounting assumptions that affect the amounts of revenues, expenses, assets and liabilities accounted for and the determination and disclosure of contingent assets and liabilities as of the end of the reporting fiscal year. In this sense, the uncertainties associated with the assumptions and estimates adopted could lead to final results in the future that may differ from such estimates and require significant adjustments to the recorded balances of affected assets and liabilities.

We have based our accounting assumptions and significant estimates considering the parameters available at the time of preparation of the consolidated financial statements. However, the current circumstances and assumptions regarding future events may vary due to changes in the market or circumstances arising beyond our control. These changes are reflected in the assumptions at the time they occur.

The accounting areas and items that require a larger number of judgments and estimates in the preparation of our consolidated financial statements are the following:

#### *Recovery of property, plant and equipment:*

As of the end of each period or year, we evaluate whether there is any indication that property, plant and equipment may be impaired. If any indication exists, we estimate the asset’s recoverable amount.

Impairment exists when the book value of assets or cash generating units exceeds their recoverable value, which is the higher between their fair value less costs of disposal of such asset and its value in use. The value of use is calculated by estimating discounted future cash flows at their present value by means of a discount rate that reflects the current evaluations of the market over the temporary value of money. Forecast calculations cover a period equal to the useful life of property, plant and equipment. The recoverable value is sensitive to the discount rate used, as well as to estimated inflows.

#### *Income tax and deferred income tax*

The valuation of the income tax expense depends on several factors, including interpretations relating to fiscal treatments of transactions and/or events not expressly contemplated by the tax law in force, as well as estimates in the opportunity and the realization of deferred taxes. Furthermore, current tax collections and payments may differ from such forward-looking estimates, all as a result, among others, of changes in tax laws and/or their interpretation, as well as unexpected future transactions that have an impact on our tax balances.

### *Business combination*

The application of the acquisition method implies the measurement at fair value of identifiable assets acquired and liabilities assumed in the business combination as of the acquisition date.

To determine the fair value of identifiable assets and liabilities, we use the valuation approach that is considered more representative for each item, namely, i) income approach, pursuant to which future amounts are converted into a sole current amount (i.e., discounted) by means of valuation techniques, ii) market approach, by means of the comparable transactions methodology and iii) cost approach by using depreciated replacement values.

In selecting the approach to be used and estimating future cash flows, management's critical judgment is required. Actual cash flows and values may significantly vary from expected future cash flows and related values obtained by means of the valuation techniques mentioned above.

### *Functional currency*

Our management applies professional judgment in determining its functional currency and that of our subsidiaries. Judgment is mainly made with respect to the currency that influences and determines the sales prices, costs of generation, materials, investments and other costs, as well as any financing and collections derived from operating activities.

### *Probability of occurrence and amount of liabilities for lawsuits and claims*

We base our estimates considering the opinions of our legal counsels available at the time of preparing the consolidated financial statements. However, the current circumstances and assumptions may vary due to changes in circumstances beyond our control.

### ***Main Items of the Statement of Comprehensive Income***

Set forth below is a brief description of the main items of our statement of comprehensive income:

#### *Revenues*

Revenues mainly correspond to our sales of energy and power (both under Energía Base and PPA revenues) and includes our steam sales and other revenues from services.

We recognize our revenues according to the availability of our plants, the dispatched energy and the delivered steam. Besides, services are billed on a monthly basis and consideration is generally received in less than 90 days (except in the case of remuneration for non-recurring maintenance and indirect additional remuneration).

Revenues from sales of energy, making available power and steam (including remuneration for non-recurring maintenance and indirect additional maintenance) are calculated at the prices set forth in the relevant agreements or at the prices set forth in the applicable regulations. These include revenues from sales of steam, energy and power, made available and/or supplied and not invoiced, as of the closing date being reported, valued at the prices defined in the agreements or in the relevant regulations.

Revenues from sales of crude oil and natural gas (discontinued operation) were recognized at the time in which ownership and risks are transferred to the customer, according to the prices of the agreements in force with the customers or based on the best price estimation to be obtained for such deliveries. For discontinued operations, see note 3.a to our Annual Audited Financial Statements.

#### *Production costs*

Our production costs include costs related to the generation of electricity and steam, such as depreciation of property, plant and equipment, salaries and social security taxes, other personnel expenses, fees and compensation for



services, transportation costs, insurance, real estate and equipment rentals, taxes, charges and other contributions, preservation, repair and maintenance, operation services and other service contracts, fuel, gas, energy and miscellaneous, consumable materials and supplies, research and development costs, and other costs. See Note 20 to our Unaudited Interim Financial Statements and Note 16 to our Audited Annual Financial Statements.

#### *Administrative and selling expenses*

Our administrative expenses include indirect expenses, such as salaries and social security taxes, other personnel expenses, fees and compensation for services, transportation expenses, real estate and equipment rentals, taxes, charges and other contributions, preservation, repair and maintenance, publicity and advertising expenses, fuel, gas, energy and miscellaneous, consumable materials and supplies. See Note 20 to our Unaudited Interim Financial Statements and Note 16 to our Annual Audited Financial Statements.

#### *Remeasurement of pre-existing equity interest*

In the three-month period ended on March 31, 2018, a Ps. 1,785 million income from the revaluation of the investment in Y-GEN and Y-GEN II was booked as a result of the acquisition of the remaining 33.33% of equity interest in such companies. For further information see Note 3.b to the Annual Audited Financial Statements.

#### *Net financial results*

Net financial results include the net value of profits or losses for interest income and expenses and exchange differences.

#### *Income from equity interests in associates*

Income from equity interests in associates include income from equity interests in companies in which we have significant influence or common control. See Note 8 to our Annual Audited Financial Statements.

#### *Income tax*

Effective tax rates for the fiscal years under analysis differ from the income tax statutory rate in Argentina (30% for the three-month period ended March 31, 2019 and 2018 and for the fiscal year ended December 31, 2018 and 35% for the fiscal year ended December 31, 2017), mainly due to the registration of the deferred tax. Deferred income tax is recognized using the liability method over the temporary differences between the tax basis of assets and liabilities and their book values as of the closing date of the reporting fiscal year/period, recognizing a deferred asset for deductible temporary differences and for the future setoff of unused tax losses (to the extent it is probable that there is future available taxable income against which such deductible temporary differences may be offset and/or such tax losses may be used) or a deferred liability for taxable temporary differences, as the case may be.

The book value of deferred tax assets is reviewed on the closing date of each reporting fiscal year and is charged to comprehensive income for the year or other comprehensive income, as applicable, to the extent it is no longer probable that there is sufficient future taxable income to allow those deferred tax assets to be used (recovered), either totally or partially. Unrecognized deferred tax assets are revaluated on the closing date of each fiscal year and recognized in net profit for the year or other comprehensive income, as applicable, to the extent the existence of future taxable income that allow to recover such unrecognized deferred tax assets is probable. See Note 2.3.6 to the Annual Audited Financial Statements.

Deferred tax assets and liabilities are measured at their face value without discount, at the tax rates that are expected to apply in the fiscal year in which the asset is realized or the liability is paid, based on the tax rates and tax regulations approved as of the closing date of the reporting fiscal year, or substantially enacted. See Note 25 to the Annual Audited Financial Statements.

## Results of Operations

### Results of operations for the three-month period ended March 31, 2019 and 2018

The following table presents our financial information as a percentage of revenues for the periods indicated:

	<b>For the three-month period ended March 31,</b>	
	<b>2019</b>	<b>2018</b>
	<b>(percentage of revenues from sales)</b>	
Revenues .....	100.0%	100.0%
Production costs .....	(33.2)%	(36.3)%
<b>Gross profit</b> .....	<b>66.8%</b>	<b>63.7%</b>
Administrative and selling expenses .....	(9.2)%	(7.6)%
Remeasurement of pre-existing equity interest .....	0.0%	277.0%
Other operating results .....	1.3%	0.0%
<b>Operating profit</b> .....	<b>58.9%</b>	<b>333.1%</b>
Income from equity interests in associates .....	4.9%	6.8%
Net financial results .....	(14.9)%	(26.9)%
<b>Net profit before income tax from continued operations</b> .....	<b>48.8%</b>	<b>313.0%</b>
Income tax .....	(7.3)%	(17.6)%
<b>Net profit for the period for continued operations</b> .....	<b>41.5%</b>	<b>295.4%</b>
Income after income tax for the period for discontinued operations .....	0.0%	2.1%
<b>Net profit for the period</b> .....	<b>41.5%</b>	<b>297.5%</b>

### Revenues

#### Type of good or service

	<b>For the three-month period ended March 31,</b>	
	<b>2019</b>	<b>2018</b>
	<b>(in thousands of Ps.)</b>	
Energía Base .....	926,128	551,522
Revenues under PPAs .....	1,629,260	11,870
Steam Sales .....	136,294	60,239
Other Services Income .....	—	20,758
<b>Total</b> .....	<b>2,691,682</b>	<b>644,389</b>

#### By Customer

	<b>For the three-month period ended March 31,</b>	
	<b>2019</b>	<b>2018</b>
	<b>(in thousands of Ps.)</b>	
CAMMESA .....	1,977,170	551,522
YPF .....	621,962	70,926
Y-GEN .....	-	10,209
Y-GEN II .....	-	10,549
UT Loma Campana .....	26,170	1,183
Profertil S.A. ....	22,152	-
Coca-Cola FEMSA de Buenos Aires S.A. ....	13,866	-
Toyota Argentina S.A. ....	12,668	-
Other .....	17,694	-
<b>Total</b> .....	<b>2,691,682</b>	<b>644,389</b>

Revenues for the three-month period ended March 31, 2019 were Ps. 2,691.7 million, representing a 317.7% increase as compared to our revenues of Ps. 644.4 million for the three-month period ended on March 31, 2018. This increase was mainly attributable to:

- Higher revenues from our PPAs. Our revenues from PPAs for the three-month period ended March 31, 2019 were Ps. 1,629.3 million, representing a 13,625.9% increase compared to Ps. 11.9 million for the three-month period ended March 31, 2018, mainly due to: (i) the consolidation since April 1, 2018 of all the revenues from our subsidiaries Y-GEN and Y-GEN II, who own our El Bracho GT and Loma Campana II thermal power plants, (ii) the commencement of commercial operation of a portion of our Manantiales Behr wind farm in July 2018 and the commencement of commercial operation of the remainder of our Manantiales Behr wind farm in December 2018 and (iii) higher operating levels of our Loma Campana I and Loma Campana Este power plants, which started to operate during the fourth quarter of fiscal year 2017. In addition, since all of our prices under our PPAs are denominated in U.S. dollars, our revenues derived from sales under our PPAs measured in pesos increased due to the depreciation of the peso with respect the U.S. dollar during 2018 and the first quarter of 2019. The depreciation affecting the exchange rates applicable for the translation (average exchange rates) to our presentation currency was of 98%.
- Higher revenue under Energía Base. Our sales under Energía Base for the three-month period ended March 31, 2019 were Ps. 926.1 million, representing a 67.9% increase compared to Ps. 551.5 million for the three-month period ended March 31, 2018, mainly due to (i) similar dispatch volumes in our thermal power plants located in the province of Tucumán, with a higher availability of those thermal power plants during such period and (ii) an increase of our volume sales of La Plata Cogeneration power plant. In addition, since all of our prices under Energía Base are denominated in U.S. dollars, our revenues derived from Energía Base measured in pesos increased due to the depreciation of the peso with respect the U.S. dollar during 2018 and the first quarter of 2019. The depreciation affecting the exchange rates applicable for the translation (average exchange rates) to our presentation currency was of 98%.
- Revenues from steam sales. Our revenues from steam sales amounted to Ps. 136.3 million for the three-month period ended March 31, 2019, representing a 126.3% increase (Ps. 76.1 million) compared to Ps. 60.2 million for the three-month period ended on March 31, 2018, mainly due to the sale of steam to YPF from our La Plata Cogeneration Plant, which was acquired in January 2018. Since prices in the agreement under which we sell the steam to YPF are denominated in U.S. dollars, our revenues from steam sales measured in pesos increased due to the depreciation of the peso with respect the U.S. dollar during 2018 and the first quarter of 2019. The depreciation affecting the exchange rates applicable for the translation (average exchange rates) to our presentation currency was of 98%.

### ***Production Costs***

The following table presents, for each of the three-month periods indicated, a breakdown of our production costs:

	<b>For the three-month period ended</b>		<b>Change (%)</b>
	<b>March 31,</b>		
	<b>2019</b>	<b>2018</b>	
	<b>(in thousands of Ps.)</b>		
Depreciation of property, plant and equipment .....	503,964	65,996	664%
Depreciation of right of use assets.....	25,756	-	N/A
Consumable materials and supplies.....	28,772	2,114	1,261%
Rentals.....	175	54	224%
Fees and compensation for services .....	5,424	217	2,400%
Other personnel expenses.....	7,309	31,501	(77%)
Preservation, repair and maintenance .....	31,718	11,525	175%
Insurance .....	39,507	7,324	439%
Salaries and social security taxes.....	96,943	70,131	38%
Operation services and other contracts .....	102,741	15,987	543%

	For the three-month period ended March 31,		Change (%)
	2019	2018	
Transportation, products and charges .....	30,923	18,689	65%
Fuel, gas, energy and miscellaneous .....	11,849	653	1,715%
Taxes, rates and contributions .....	2,423	4,639	(48%)
Miscellaneous.....	5,314	4,890	9%
<b>Total .....</b>	<b>892,818</b>	<b>233,720</b>	<b>282%</b>

Production costs for the three-month period ended March 31, 2019 were Ps. 892.8 million, representing a 282% increase as compared to our production costs of Ps. 233.7 million for the three-month period ended on March 31, 2018. This increase was mainly due to:

- An increase of Ps. 438 million in the depreciation of property, plant and equipment resulting mainly from the consolidation of the depreciation of property, plant and equipment from the 33.33% equity interest in Y-GEN and Y-GEN II, totaling Ps. 266 million, and the completion of the Manantiales Behr wind farm during the second half of 2018, totaling Ps. 86 million, together with the effect of the appreciation of all the assets subject to depreciation, taking into account their valuation in historical dollars, according to our functional currency. The depreciation affecting the exchange rates applicable for the translation of depreciation charges (average exchange rates) to our presentation currency was of 98%.
- An increase of Ps. 26.8 million in salaries and social security taxes resulting mainly from the salary increases for the year 2018 and to the increase in payroll since March 31, 2018.
- An increase of Ps. 106.9 million in operation services and other contracts and preservation, repair and maintenance costs mainly due to higher activity levels of our thermal power plants, the start of commercial operation of our Manantiales Behr wind farm and the consolidation of Y-GEN and Y-GEN II (Ps. 21 million) together with the effect of depreciation of the peso with respect to the U.S. dollar. The depreciation affecting the exchange rates applicable for the translation of these charges (average exchange rates) to our presentation currency was of 98%.
- An increase of Ps. 26.7 million in consumable materials and supplies, due to increased activity and the consolidation of Y-GEN and Y-GEN II.
- An increase of insurance costs of Ps. 32.2 million (of which Ps. 12 million derive from the consolidation of Y-GEN and Y-GEN II's results), as a result of the higher activity levels of our thermal power plants, the start of commercial operation of our Manantiales Behr wind farm and the effects of the depreciation of the peso.

#### *Administrative and selling expenses*

The following table presents, for each of the three-month periods indicated, a breakdown of our administrative and selling expenses:

	For the three-month period ended March 31,		Change (%)
	2019	2018	
	(in thousands of Ps.)		
Depreciation of right of use assets.....	5,497	–	N/A
Consumable materials and supplies.....	2,129	216	886%
Banking expenses.....	101	198	(49%)
Rentals.....	3,094	136	2,175%
Fees and compensation for services .....	7,005	3,981	76%
Other personnel expenses.....	13,137	2,415	444%
Preservation, repair and maintenance.....	21	471	(96%)

	For the three-month period ended March 31,		Change (%)
	2019	2018	
Insurance .....	87	–	N/A
Salaries and social security taxes.....	70,961	17,533	305%
Provision for doubtful trade receivables.....	48,772	–	N/A
Taxes, rates and contributions .....	92,030	16,891	445%
Publicity and advertising expenses.....	713	24	2,871%
Miscellaneous.....	4,219	7,352	(43%)
<b>Total .....</b>	<b>247,766</b>	<b>49,217</b>	<b>403%</b>

Administration and selling expenses for the three-month period ended March 31, 2019, were Ps. 247.8 million, representing a 403.4% increase as compared to our administration and selling expenses of Ps. 49.2 million for the three-month period ended on March 31, 2018. This increase was mainly attributable to an increase of Ps. 75 million in taxes, rates and contributions due to increased activity (Ps. 38 million of which derived from the consolidation of Y-GEN and YGEN II's results), a Ps. 64 million increase in higher salaries and social security taxes and other personnel expenses due to the increase of the payroll and salaries, and a Ps. 49 million increase in provision for doubtful trade receivables.

### ***Operating profit***

Operating profit for the three-month period ended March 31, 2019, was Ps. 1,584.9 million, representing a 26.2% decrease as compared to our operating profit of Ps. 2,146 for the three-month period ended March 31, 2018, mainly attributable to the factors described above and the remeasurement of pre-existing equity interest of Ps. 1,785 million recorded during first quarter of 2018. If we exclude this last item, the operating profit for the three-month period ended March 31, 2019 was higher than the Ps.1,223.8 million operating profit for the three-month period ended March 31, 2018, representing an increase of 338.8%.

### ***Income from equity interests in associates***

Our income from equity interests in associates for the three-month period ended March 31, 2019 was Ps. 131.1 million, an increase of 198.5% compared to our income from equity interests in associates of Ps. 43.9 million for the three-month period ended March 31, 2018, mainly attributable to results from the indirect investment in the associate CDS as a result of its higher sales.

### ***Net financial results***

Our net financial result for the three-month period ended March 31, 2019, was a loss of Ps. 401.7 million, a 132% decrease as compared to a loss of Ps 173.1 million for the three-month period ended March 31, 2018, mainly attributable to an increase in interest loss and finance accretion amounting to Ps. 316.6 million, mainly due to the consolidation of the finance loss of our subsidiaries Y-GEN and Y-GEN II as of March 31, 2019 and the new loans incurred in the second half of 2018.

### ***Income Tax***

Our income tax for the three-month period ended March 31, 2019 was an expense of Ps. 197.1 million, a 74.2% increase as compared to an expense of Ps 113.1 million loss for the three-month period ended March 31, 2018, mainly attributable to an increase of deferred tax liability, which amounted to Ps. 887.4 million, generated by the consolidation of Y-GEN and Y-GEN II's results and a higher translation effect of property, plant and equipment partially offset by a tax revaluation of these assets. The devaluation of the exchange rates applicable for the translation of income tax expense (average exchange rates) to our presentation currency was of 98%. These effects were partially compensated with tax loss carryforwards recorded for the three-month period ended on March 31, 2019 which amounted to Ps. 437.6 million.

### ***Discontinued operations***

No results for discontinued operations have been recorded for the operation of the Ramos Area in the three-month period ended March 31, 2019, as compared to the Ps. 13.3 million of net profit generated during the three-month period ended March 31, 2018, due to the sale of our equity stake in the Ramos Area, which we assigned and transferred to YPF on February 2, 2018. As a result of this operation, the income generated by the Ramos Area was disclosed under “Profit after income tax for the period from discontinued operations” for the results of operations for the three-month period ended in March 31, 2018 for comparative purposes, as required under IFRS.

### ***Net profit***

For the above reasons, our net profit for the three-month period ended March 31, 2019 amounted to Ps. 1,117.3 million, a 41.7% decrease as compared to the Ps. 1,917.1 million of net profit for the three-month period ended March 31, 2018.

### ***Other comprehensive income***

Other comprehensive income for the three-month period ended on March 31, 2019 was Ps. 3,907.7 million, an increase of 992.1% compared to the Ps. 357.8 million generated in the three-month period ended March 31, 2018. This increase arises from the translation differences from the functional currency (U.S. dollar) to the presentation currency (pesos) because of the devaluation of the Argentine peso during the three-month period ended March 31, 2019, mainly affecting property, plant and equipment and loans, and the changes in the fair value of cash flow hedge instruments of our subsidiaries Y-GEN and Y-GEN II.

Based on the above reasons, total comprehensive income for the three-month period ended March 31, 2019 was Ps. 5,024.9 million, a 121% increase compared to Ps. 2,274.9 million in the three-month period ended March 31, 2018.

### ***Results of operations for the fiscal years ended December 31, 2018 and 2017***

The following table presents our financial information as a percentage of revenues for the fiscal years indicated:

	<b>For the fiscal year ended December 31,</b>	
	<b>2018</b>	<b>2017</b>
	<b>(percentage of revenues)</b>	
Revenues .....	100.0%	100.0%
Production costs .....	(33.7%)	(30.2%)
<b>Gross profit</b> .....	66.3%	69.8%
Administrative and selling expenses .....	(7.6%)	(12.5%)
Remeasurement of pre-existing equity interest .....	25.1%	0.0%
Other net operating results.....	0.0%	0.0%
<b>Operating profit</b> .....	83.7%	57.30%
Income from equity interests in associates .....	3.8%	4.6%
Net financial results.....	(18.6%)	0.8%
<b>Net profit before income tax from continued operations</b> .....	68.9%	62.7%
Income tax .....	(5.9%)	(18.3%)
<b>Net profit for the year for continued operations</b> .....	63.0%	44.4%
Income after income tax for the year from discontinued operations .....	0.2%	13.2%
<b>Net profit for the year</b> .....	<b>63.2%</b>	<b>57.6%</b>

## Revenues

The following table presents, for the fiscal years indicated, revenues per type of good or service and per customer.

<u>Type of good or service</u>	<b>For the year ended December 31,</b>	
	<b>2018</b>	<b>2017</b>
	<b>(in thousands of Ps.)</b>	
Energía Base.....	3,268,971	1,363,882
Revenues under PPAs .....	3,448,667	31,165
Steam sales .....	386,509	-
Other services income .....	20,758	75,623
<b>Total</b> .....	<b>7,124,905</b>	<b>1,470,670</b>

<u>By Customer</u>	<b>For the year ended December 31,</b>	
	<b>2018</b>	<b>2017</b>
	<b>(in thousands of Ps.)</b>	
CAMMESA.....	5,881,414	1,363,882
YPF .....	1,119,111	19,448
Y-GEN .....	10,209	37,325
Y-GEN II .....	10,549	38,298
UT Loma Campana .....	69,922	11,717
Profertil S.A. ....	8,979	-
Coca- Cola FEMSA de Buenos Aires S.A. ....	9,222	-
Toyota Argentina S.A. ....	9,114	-
Other.....	6,385	-
<b>Total</b> .....	<b>7,124,905</b>	<b>1,470,670</b>

Our revenues for the year ended December 31, 2018 were Ps. 7,124.9 million, a 384.5% increase compared to our revenues of Ps. 1,470.7 million for the year ended December 31, 2017. This increase was mainly attributable to:

- Higher revenues from our PPAs. Our revenues from PPAs for the year ended December 31, 2018 were Ps. 3,448.7 million, a 10,965.8% increase compared to Ps. 31.2 million for the year ended December 31, 2017, mainly due to (i) the consolidation of the revenues from Y-GEN and Y-GEN II, who own our El Bracho GT and Loma Campana II thermal power plants, (ii) the commencement of commercial operation of a portion of our Manantiales Behr wind farm in July 2018 and final commercial operation of the remainder of our Manantiales Behr wind farm in December 2018 and (iii) higher operating levels of our Loma Campana I and Loma Campana Este power plants, which started commercial operations during the fourth quarter of fiscal year 2017. In addition, since all of our prices under our PPAs are denominated in U.S. dollars, our revenues from sales under our PPAs measured in pesos increased due to depreciation of the peso with respect to the U.S. dollar during 2018. The depreciation affecting the exchange rates applicable for the translation (average exchange rates) to our presentation currency was of 69%.
- Higher revenues under Energía Base. Our sales under Energía Base for the year ended December 31, 2018 were Ps. 3,269 million, a 139.7% increase compared to Ps. 1,363.9 million for the year ended December 31, 2017, mainly due to (i) similar dispatch volumes in our thermal power plants located in the province of Tucumán, with an 11% increase in availability and (ii) an increase of our volume sales derived from the acquisition of La Plata Cogeneration power plant from Central Puerto S.A. in February 2018, effective as of January 5, 2018. In addition, since all of our prices under Energía Base are

denominated in U.S. dollars, our revenues derived from sales under Energía Base measured in pesos increased due to depreciation of the peso with respect the U.S. dollar during 2018. The depreciation affecting the exchange rates applicable for the translation (average exchange rates) to our presentation currency was of 69%.

- Revenues from steam sales. Our revenues from steam sales from our La Plata Cogeneration Plant, which was acquired in January 2018 amounted to Ps. 386.5 million for the year ended on December 31, 2018.

### **Production Costs**

The following table presents, for each of the fiscal years indicated, a breakdown of our production costs:

	<b>For the years ended December 31</b>		<b>Change (%)</b>
	<b>2018</b>	<b>2017</b>	
	<b>(in thousands of Ps.)</b>		
Depreciation of property, plants and equipment.....	1,279,867	76,840	1,566%
Consumable materials and supplies.....	50,153	40,950	22%
Banking expenses.....	4	-	N/A
Rentals.....	3,865	432	795%
Fees and compensation for services.....	17,539	5,259	234%
Other personnel expenses.....	26,072	17,599	48%
Preservation, repair and maintenance.....	148,733	57,777	157%
Insurance.....	89,596	17,944	399%
Salaries and social security taxes.....	422,069	125,284	237%
Operation services and other contracts.....	121,960	22,307	447%
Transportation, products and charges.....	153,312	72,417	112%
Fuel, gas, energy and miscellaneous.....	44,363	1,748	2,438%
Taxes, rates and contributions.....	6,779	-	N/A
Research and development.....	6,343	-	N/A
Miscellaneous.....	30,970	5,089	509%
<b>Total.....</b>	<b>2,401,625</b>	<b>443,646</b>	<b>441%</b>

Production costs for the year ended December 31, 2018 amounted to Ps. 2,401.6 million, an increase of 441.3% compared to the Ps. 443.6 million of production cost for the year ended December 31, 2017, mainly due to:

- An increase in depreciation of property, plant and equipment of Ps. 1,203 million as a result of the completion of our Loma Campana II power plant (owned by Y-GEN), El Bracho power plant (owned by Y-GEN II), the opened cycle of Loma Campana I power plant, the combined cycle plant in Tucumán, the Loma Campana Este power plant and our Manantiales Behr wind farm, together with the effect of the appreciation of all the assets subject to depreciation, taking into account their valuation in historical dollars, according to our functional currency. The depreciation affecting the exchange rates applicable for the translation of depreciation charges (average exchange rates) to our presentation currency was of 69%.
- An increase in salaries and social security taxes and other personnel expenses of Ps. 305 million, directly related to the increase in our activity due to the start of operations of Loma Campana II thermal power plant (owned by Y-GEN), El Bracho GT thermal power plant (owned by Y-GEN II), the opened cycle of Loma Campana I thermal power plant, the Combined Cycle Tucumán Power Plant, the Loma Campana Este power plant and our Manantiales Behr wind farm, and, to a lesser extent, to salary increases. In 2018, our average payroll increased to 242 people, representing a 113.1% increase compared to the average payroll in 2017.
- Increase in operation services and other contracts for construction of Ps. 99.7 million and preservation, repair and maintenance costs of Ps. 91 million primarily as a result of the commencement of the commercial operation of Loma Campana II thermal power plant (owned by Y-GEN), El Bracho GT



thermal power plant (owned by Y-GEN II), the opened cycle of Loma Campana I thermal power plant, the Loma Campana Este power plant and our Manantiales Behr wind farm.

- Increases in transportation, products and charges costs of Ps. 80.9 million and insurance of Ps. 71.7 million as a result of the increase in activity described above.

Our production costs represented 33.7% and 30.2% of our revenues in the years ended December 31, 2018 and 2017, respectively.

### *Administrative and selling expenses*

The following table presents, for each of the years indicated, a breakdown of our administrative and selling expenses:

	<b>For the year ended December 31,</b>		<b>Change (%)</b>
	<b>2018</b>	<b>2017</b>	
	<b>(in thousands of Ps.)</b>		
Consumable materials and supplies.....	1,564	1,242	26%
Banking expenses.....	2,742	512	436%
Rentals.....	13,433	11	122,018%
Fees and compensation for services .....	63,056	71,428	(12%)
Other personnel expenses.....	55,506	7,639	627%
Preservation, repair and maintenance.....	5,682	-	N/A
Insurance .....	305	827	(63%)
Salaries and social security taxes .....	108,151	31,321	245%
Taxes, rates and contributions .....	272,924	50,829	437%
Publicity and advertising expenses.....	1,806	8	22,475%
Miscellaneous.....	19,245	19,691	(2%)
<b>Total .....</b>	<b>544,414</b>	<b>183,508</b>	<b>197%</b>

Administrative and selling expenses for the year ended December 31, 2018 were Ps. 544.4 million, representing a 196.7% increase compared to administrative and selling expenses of Ps. 183.5 million for the year ended December 31, 2017, mainly as a result of increases in taxes, rates and contributions, salaries and social security taxes and other personnel expenses.

### *Remeasurement of pre-existing equity interest*

In the fiscal year ended December 31, 2018, Ps. 1,785 million in income from the revaluation of the investment in Y-GEN and Y-GEN II was booked as a result of the acquisition of the remaining 33.33% of equity interest in such companies. For further information see Note 3.b to the Annual Audited Consolidated Financial Statements.

### *Operating profit*

Due to the factors described above, operating profit for the year ended December 31, 2018 was Ps. 5,963.6 million a 607.6% increase compared to operating profit of Ps. 842.8 million in the year ended December 31, 2017.

### *Income from equity interests in associates*

Income from equity interests in associates for the year ended December 31, 2018 were Ps. 268 million, an increase of 297% compared to Ps. 67.5 million the year ended December 31, 2017. This increase was due to higher income from the indirect investment in our associate CDS as a result of higher sales of energy.

### ***Net financial results***

Net financial results for the year ended December 31, 2018 were a loss of Ps. 1,322.5 million, a decrease of Ps. 1,334.1 million compared to a profit of Ps. 11.6 million in the year ended December 31, 2017. Such decrease was mainly due to an increase in exchange losses on monetary assets, net of Ps. 878.2 million, derived from the depreciation of the peso during 2018 and compared to 2017. In addition, we recorded increased interest expense in the amount of Ps. 528 million (partially offset by the increase in interest income of Ps. 72 million), as a result of an increase in average financial indebtedness, including loans granted by the Inter-American Investment Corporation on behalf of the Inter-American Development Bank for an aggregate amount of up to US\$200 million for the construction of the Manantiales Behr wind farm and the loans granted by Citigroup Global Markets, Inc., Credit Suisse Securities (USA) LLC and Export Development Canada, to finance the construction in Loma Campana II thermal power plant and El Bracho GT thermal power plant for an amount of up to US\$219.5 million.

### ***Income tax***

Our income tax expense for the year ended December 31, 2018 was Ps. 419 million, which includes Ps. 131 million for the special tax revaluation under Law No. 27,430 (the “Tax Reassessment”) (See Note 25 to our Audited Annual Financial Statements) and Ps. 2 million for income tax for discontinued operations, compared to a Ps. 366 million expense in the year ended December 31, 2017, which includes Ps. 97 million for income tax for discontinued operations (See Note 18 to our Audited Annual Financial Statements). This represents a 14.5% increase primarily as a result of an increase in deferred tax liabilities, partially offset by the adjustment in results due to a reduction in tax rates as from the year ended December 31, 2018, pursuant to the changes introduced by Law No. 27,430 and the effect of the application of the Tax Reassessment. The increase in deferred tax liabilities is mainly due to the difference between the book value and the tax value of property, plant and equipment, primarily as a result of the translation of amounts of such item measured on the basis of our functional currency (U.S. dollars) to our presentation currency (Ps.), as a result of the depreciation occurred during the fiscal year. The depreciation affecting the exchange rates applicable for the translation of income tax expense to our presentation currency was of 69%.

### ***Discontinued operations***

On February 2, 2018, we assigned and transferred to YPF the 27% equity interest held in the Ramos Area in the province of Salta (See Notes 3.a and 18 to the Audited Annual Financial Statements). As a result of this transaction, the results generated by the Ramos Area until its sale have been recorded as results from discontinued operations, as well as those generated in the year ended December 31, 2017 for comparative purposes, as required by IFRS. In this sense, during the year ended December 31, 2018, net profit from the operation of the Ramos Area was Ps. 13.3 million, a 93.1% decrease compared to Ps. 194.0 million generated in the year ended December 31, 2017, mainly due to the fact that during 2018 only 33 days of operation were accounted for.

### ***Net profit***

For the above reasons, our net profit for the year ended in December 31, 2018 was Ps. 4,505.4 million, a 432% increase compared to Ps. 846.8 million of net profit in the year ended in December 31, 2017.

### ***Other comprehensive income***

Other comprehensive income for the year ended in December 31, 2018 was Ps. 11,197.1 million, a 1,965.1% increase compared to Ps. 542.2 million of other comprehensive income for the year ended in December 31, 2017, mainly due to the depreciation of the peso with respect to the U.S. dollar in 2018 that caused an increase in the translation differences given that our functional currency is U.S. dollar and our presentation currency is pesos and the variation in the fair value of cash flow hedge instruments of our controlled companies, Y-GEN and Y-GEN II.

### **Liquidity and Capital Resources**

Our capital requirements are primarily for operational and maintenance costs related to our operating assets, capital expenditures related to the construction of new power generation assets, acquisitions and debt service

payments. Our primary sources for liquidity and capital resources are funds generated by our operating businesses, primarily power generation, finance income from the investment of our cash and available funds, access to debt capital markets and the bank lending market.

### *Cash flow*

The table below presents information on our cash flows for the periods/years indicated:

	For the three months period ended March 31,		For the year ended December 31,	
	2019	2018	2018	2017
	<b>(In thousands of Ps.)</b>			
Net cash flows from operating activities .....	1,715,423	393,523	5,436,708	901,168
Net Cash flows used in investing activities .....	(4,121,527)	(2,834,987)	(10,829,186)	(3,004,469)
Net Cash flows from financing activities .....	4,633,313	3,955,697	9,292,223	1,522,203
<b>Net increase (decrease) of cash and cash equivalents .....</b>	<b>2,227,209</b>	<b>1,514,233</b>	<b>3,899,745</b>	<b>(581,098)</b>
Effect of exchange difference variations on cash and cash equivalents	704,290	34,435	662,509	68,733
Cash and cash equivalents at the beginning of the period/year .....	4,701,336	139,082	139,082	651,447
<b>Cash and cash equivalents at fiscal period/year-end....</b>	<b>7,632,835</b>	<b>1,687,750</b>	<b>4,701,336</b>	<b>139,082</b>

*Years ended December 31, 2018 and December 31, 2017*

Our cash flows generated from operating activities for the year ended December 31, 2018 amounted to Ps. 5,436.7 million, a 503.3% compared to the previous year. This Ps. 4,535.5 million increase was mainly attributable to an increase in our operating profit of continued operations, excluding depreciation and remeasurement of pre-existing equity interest of Ps. 4,538.8 million, and a result of a working capital decrease after excluding the effect of net assets acquired from Y-GEN and Y-GEN II.

Our cash flows used in investing activities in investing activities for the year ended December 31, 2018 amounted to Ps. 10,829.2 million, a 260.4% increase compared to the previous year, mainly attributable to higher disbursements to afford investments in property, plant and equipment, which reached Ps. 7,838.7 million during fiscal year 2018, accounting for a 261.1% increase compared to the previous year. Furthermore, acquisitions of equity interests in other companies were Ps. 1,524 million, mainly due to the purchase of the 33.33% remaining equity interest in Y-GEN and Y-GEN II. Finally, during the year ended December 31, 2018, there were investments in other financial assets totaling Ps. 1,290.5 million.

As a result of our financing activities, during the year ended December 31, 2018, we recorded a higher net increase in cash flows of Ps. 7,770 million. This increase was mainly due to the loans disbursed (net of repayments) totaling Ps. 5,823 million, offset by higher capital contributions of Ps. 2,720.3 million as a result of the incorporation of GE as partner.

*Three-month period ended March 31, 2019, and three-month period ended March 31, 2018*

Operating cash for the three-month period ended March 31, 2019 amounted to Ps. 1,715.4 million, a 335.9% increase compared to the three-month period ended March 31, 2018. This Ps. 1,321.9 million increase resulted from higher operating profits mainly derived from an increase in the revenue from our power plants that commenced commercial operations during 2018, without considering the result of the first quarter of 2018 for the remeasurement of pre-existing equity interest in Y-GEN and Y-GEN II, partially offset by an increase in working capital.

Cash flows used in investing activities were Ps. 4,121.5 million for the three-month period ended March 31, 2019, an increase of 45.4% compared to the three-month period ended March 31, 2018, mainly due to acquisition of property, plant and equipment totaling Ps. 3,234 million, used mainly for El Bracho ST, LPC II and Los Teros I, which was 95% higher than those from the same period of 2018.

In addition, as a result of its financing activities, net cash flows increased to Ps. 4,633.3 million. This variation was mainly generated by the collection of the second installment corresponding to the share subscription price from our shareholder GE. See “Business – History and Development”.

The resource generation explained above gives rise to a position in cash and cash equivalents of Ps. 7,632.8 million as of March 31, 2019. In addition, our financial loans were Ps. 27,753.8 million for the three-month period ended March 31, 2019, of which only 24.5% of the total amount is due and payable in the short term.

## Contractual Obligations

The following table (prepared on the basis of our internal information) contains information about our contractual obligations, stated in millions of U.S. dollars, our functional currency, under existing contracts as of March 31, 2019:

Contractual obligations <sup>(1)</sup>	Total	Less than			More than 5 years
		1 year	1-3 years	3-5 years	
		(in millions of US\$) <sup>(5)</sup>			
Loans <sup>(2)</sup> .....	755.7	208.2	347.7	169.0	30.8
O&M Services <sup>(3)</sup> .....	314.5	23.4	49.2	68.5	173.4
Other Liabilities <sup>(4)</sup> .....	176.1	166.9	4.5	1.4	3.3
Total .....	1,246.3	398.5	401.4	238.9	207.5

- (1) The expected timing for payments of the obligations in the preceding table is estimated based on current information. Timing of payments and actual amounts paid may be different, depending on the time of receipt of goods or services, or changes to agreed upon amounts for some obligations.
- (2) These projected amounts include interest due during all the periods presented. Interest on floating rate instruments is calculated using the rate as of March 31, 2019. In addition, see “Management’s Discussion and Analysis of Financial Condition and Results of Operations—Liquidity and Capital Resources—Covenants in our indebtedness.”
- (3) Includes payments under agreements for operation and maintenance services for all of our plants.
- (4) Includes accounts payable, leases liabilities, salaries and social security, taxes payable, provisions and other liabilities.
- (5) Amounts originally denominated in Argentine pesos were translated using closing exchange rate as of March 31, 2019.

## Indebtedness

	As of March 31,	As of December 31,
	2019	2018
	(In thousands of Ps.)	
<u>Current loans and leases liabilities:</u>		
Financial loans.....	6,809,814	6,463,984
Financial leases.....	-	50,424
Leases liabilities .....	100,748	-
Total current loans and leases liabilities .....	6,910,562	6,514,408
<u>Non-current loans:</u>		
Financial loans.....	20,943,971	18,096,828
Financial leases.....	-	159,742
Leases liabilities .....	358,553	-
Total non-current loans.....	21,302,524	18,256,570
<b>Total loans and leases liabilities.....</b>	<b>28,213,086</b>	<b>24,770,978</b>

Total financial loans outstanding as of March 31, 2019 was Ps. 27,753.8 million, consisting of current loans (including the current portion of non-current loans) of Ps. 6,809.8 million and non-current loans of Ps. 20,944 million. All our indebtedness was denominated in U.S. dollars. As of March 31, 2019, financial indebtedness included leases liabilities pursuant to IFRS 16 for Ps. 459.3 million (including Ps. 227.6 million with Banco Supervielle S.A., in the form of leaseings, for the purchase of twelve generators), while as of March 31, 2018, prior to the application of IFRS 16, such leases liabilities were accounted for in financial loans and financial leases. For further information about IFRS 16 application, see Note 2.6.1 to our Annual Audited Consolidated Financial Statements and Note 2.b) to our Unaudited Interim Financial Statements.

Total financial loans outstanding as of December 31, 2018 was Ps. 24,771 million, consisting of current loans (including the current portion of non-current loans) of Ps. 6,464 million and non-current loans of Ps. 18,097 million.

Furthermore, as of December 31, 2018, financial indebtedness included financial leases for Ps. 210 million with Banco Supervielle S.A. (in the form of leaseings) for the purchase of twelve generators. There are six agreements in the aggregate, three of which accrue interest at a nominal annual implied rate of 8.35% and the remaining three at 7.75%. These agreements provide for the exercise of a purchase option upon expiration of the term.

As of March 31, 2019 and December 31, 2018, all our indebtedness was denominated in U.S. dollars.

The following table summarizes the principal terms and conditions of our outstanding financial loans as of March 31, 2019.

<b>Loans and leasing</b>	<b>Outstanding principal as of March 31, 2019</b>	<b>Interest Rate</b>	<b>Date</b>	<b>Maturity</b>
Inter-American Investment Corporation and Inter-American Development Bank [Tranche 1]	US\$100,000,000	Different rates (see further details below)	December 2, 2016	November 15, 2025
Inter-American Investment Corporation and Inter-American Development Bank [Tranche 2]	US\$100,000,000	3-month Libor + 4.8%	December 2, 2016	November 15, 2022
Citigroup Global Markets Inc., Credit Suisse Securities (USA) LLC and Export Development Canada	US\$184,951,400	3-month Libor + 5.375%	June 14, 2017	June 2022
Citibank, N.A. [Loan 1]	US\$30,000,000	Quarterly; 3-month Libor + 4.875%	February 28, 2019	February 26, 2021
Citibank, N.A. [Loan 2]	US\$30,000,000	Quarterly; 3-month Libor + 1.85%	June 27, 2018	June 28, 2019
Banco de Galicia y Buenos Aires S.A. [Loan 1]	US\$20,000,000	Annually; 5.00%	August 17, 2018	August 17, 2019
Banco de Galicia y Buenos Aires S.A. [Loan 2]	US\$20,000,000	Annually; 8.40%	September 3, 2018	September 3, 2021
BBVA Banco Francés S.A.	US\$15,000,000	Biannually; 8.40%	August 17, 2017	August 17, 2021
BBVA Banco Francés S.A.	US\$15,000,000	Biannually; 8.40%	August 17, 2017	August 17, 2021
Itaú Unibanco S.A., Nassau Branch	US\$50,000,000	Quarterly; 3-month Libor + 5%	September 24, 2018	September 24, 2019
Banco Latinoamericano de Comercio Exterior, S.A. and Industrial and Commercial Bank of China (Argentina) S.A.	US\$75,000,000	Quarterly; 3-month Libor + 5.375% <sup>(1)</sup>	November 23, 2018	November 23, 2021

(1) *Libor + margin to offshore lenders, and Libor + margin + withholding taxes rate to onshore lender.*

(2) *Average rate. Interest rate is variable.*

As of March 31, 2019, we had unsecured outstanding loans for US\$458.7 million and secured loans for US\$185 million, for an aggregate amount of US\$643.7 million.

#### *Loan from Inter-American Development Bank and Inter-American Investment Corporation.*

On December 2, 2016, we received a loan from the Inter-American Development Bank and the Inter-American Investment Corporation, on its own behalf and as agent of the Inter-American Development Bank, to finance the construction of Manantiales Behr wind farm, for up to a principal amount of US\$200 million. The loan has been disbursed in two tranches of US\$100 million that accrue interest at different rates and mature in seven and nine years, respectively. The capital amortization will be performed in two quarterly payments starting in February 2020. The following table summarizes the loan structure and the applicable interest rate.

Tranche	US\$	Rate
A	31,075,076	3-month Libor + 5.125%
A	12,539,359	7.16%
A	18,000,032	7.05%
A	19,506,895	7.27%
A	18,878,638	7.87%
B	100,000,000	3-month Libor + 4.8%
Total	200,000,000	

*Loan from Citigroup Global Markets Inc., Credit Suisse Securities (USA) LLC and Export Development Canada*

On June 14, 2017, we received, through Y-GEN and Y-GEN II, a loan from Citigroup Global Markets Inc., Credit Suisse Securities (USA) LLC and Export Development Canada for a total amount of US\$219.5 million. US\$70 million was allocated to finance the construction of the Loma Campana II thermal power plant in the Province of Neuquén, and the remaining US\$149,500,000 was allocated to finance the construction of El Bracho GT power plant in the Province of Tucumán. However, as of December 31, 2018, disbursements made were US\$211,973,875 (US\$70 million for Y-GEN, owner of Loma Campana II and US\$141,973,875 for Y-GEN II, owner of El Bracho GT). As this financing requires that the flow of funds from CAMMESA, as offtaker, to Y-GEN and Y-GEN II be either (i) reinvested in the construction of the Loma Campana II thermal power plant and the construction of El Bracho GT power plant or (ii) used to repay the loan, we will not receive any funds from Y-GEN and Y-GEN II in relation to the Loma Campana II thermal power plant and the El Bracho GT power plant until such loan has been repaid or cancelled in full.

The agreed interest rate is 3-month Libor interest rate + 4.00% until the construction completion date and, thereafter, a 3-month Libor interest rate + 5.75% until maturity and the term for principal repayment is five years (includes a 15-month grace period) with repayment of approximately 44% of principal in 15 quarterly installments commencing on September 2018, and one installment for the remaining balance of approximately 56% of principal at the end of a 5-year term on June 30, 2022.

In connection with the loan, Y-GEN and Y-GEN II have agreed, among other things, to contract hedging instruments as a means of protection against Libor fluctuations. As a result, in June 2017, such companies executed an interest rate hedge agreement with Citibank, N.A., London Branch for a 5-year term, with coverage beginning as of December 31, 2017, over an initial notional amount of approximately US\$156 million (US\$50 million corresponding to Y-GEN, and the remaining US\$106 million corresponding to Y-GEN II). The interest rate hedge provides that the companies will pay fixed amounts at a set rate of 1.947% and they will receive variable amounts subject to three-month Libor.

The loan contract also includes certain restrictive covenants: Y-GEN and Y-GEN II have to maintain a 70% - 30% ratio between the amounts obtained under the loan and the capital contributions made prior to each disbursement period, both measured in U.S. dollars at the time they were made, and also, from the date of the first principal installment repayment, they must meet a principal repayment coverage ratio measured on the basis of certain cash flows generated during the year ended at each such measurement date and the principal repayments for such period, which may not be below 1.05.

This financing involves the following guarantees, which we believe are standard for this type of financing:

- Construction guarantee until the construction completion date by GE.
- Guarantee of the members' capital contributions (today, the single shareholder).
- Foreign reserve accounts after the construction completion date, which as of December 31, 2018 amounted to Ps. 1,489,031 thousand.
- Guarantee from the partners regarding the reserves until the latter reaches the minimum required.

- Pledge of equipment installed in both plants.
- Pledge of the units of the members of Y-GEN and of the members of Y-GEN II (currently on the shares of the single shareholder) and the assignment of dividend payments in favor of an onshore collateral agent for the benefit of the lenders.
- Pledge of the offshore bank accounts of Y-GEN and Y-GEN II.
- Assignment in trust as guarantee of all the rights of Y-GEN and Y-GEN II.

*Loans from Citibank N.A.*

In March 2018, we received a loan from Citibank, N.A. for a total amount of US\$30 million to finance working capital. The loan accrued quarterly at a 3-month Libor interest rate plus 1.6%, and had a principal bullet repayment on August 28, 2018, its date of maturity. After such date, we extended the maturity of the loan through February 28, 2019, at 3-month Libor interest rate plus 2.25%. After such date, we extended the maturity of the loan through February 26, 2021, at an interest rate equal to three-month Libor plus 4.875%.

On June 28, 2018, we received a second loan from Citibank, N.A. for a total amount of US\$30 million to finance working capital. The loan accrues quarterly at a 3-month Libor interest rate plus 1.85%, and has a principal bullet repayment on June 28, 2019, its date of maturity. At the maturity date, the loan was renewed until September 30, 2019 with a 3-month Libor interest rate plus 3.95%.

*Loans from Banco de Galicia y Buenos Aires S.A.*

On August 17, 2018, we received a loan from Banco de Galicia y Buenos Aires S.A. for a total amount of US\$20 million to finance certain investment projects and working capital. The loan accrues interest at an annual fixed rate of 5.00%, and has a principal bullet repayment on August 17, 2019, its maturity date.

On September 3, 2018, we received a second loan from Banco de Galicia y Buenos Aires S.A. for a total amount of US\$20 million to finance certain investment projects and working capital. The loan accrues interest quarterly at a fixed rate of 8.35% and matures on September 3, 2021. The principal amount of the loan is payable in nine quarterly installments starting on September 3, 2019.

The terms of the loans include financial covenants throughout the terms of the loans, which include leverage ratio and debt coverage ratio.

*Loans from BBVA Banco Francés S.A.*

On August 17, 2018, we received two loans from BBVA Banco Francés S.A., each for an aggregate amount of US\$15 million to finance working capital, repay indebtedness and/or for the acquisition of capital assets. The loans accrue interest semi-annually at a fixed rate of 8.40% and mature on August 17, 2021. The principal of the loans is repayable in three annual installments starting on August 19, 2019.

The terms of the loans include financial covenants, which include leverage ratio and debt coverage ratio.

*Loan from Itaú Unibanco S.A., Nassau Branch*

On September 24, 2018, we received a loan from Itaú Unibanco S.A., Nassau Branch for an aggregate amount of US\$50 million to cover general financing needs. The loan accrues interest quarterly at a 3-month Libor interest rate plus 5.00%, and has a principal bullet repayment on September 24, 2019, its maturity date.

The terms of the loan include financial covenants throughout the terms of the loans, including leverage ratio and debt coverage ratio.

*Syndicated Loan from Banco Latinoamericano de Comercio Exterior, S.A. and Industrial and Commercial Bank of China (Argentina) S.A.*

On November 29, 2018, we received a loan from Banco Latinoamericano de Comercio Exterior, S.A. and Industrial and Commercial Bank of China (Argentina) S.A. for an aggregate amount of US\$75,000,000 to finance capital investments and other general funding needs. The loan accrues interest quarterly at a 3-month Libor interest rate plus 5.75%, and matures on November 23, 2021. The principal amount of this loan is repayable in four equal monthly installments on the date that is 24, 29, 30 and 36 months after the disbursement.

The terms of the loan include financial covenants, including leverage ratio and debt coverage ratio.

### ***Guarantees Provided***

In order to guarantee certain of our obligations under the PPAs with CAMMESA (mainly the commitment of commercial operation dates), surety bonds were issued in favor of CAMMESA for the following amounts: (i) US\$8,352,144 under the PPA for LPC II, (ii) US\$26,373,600 under the PPA for El Bracho ST, (iii) US\$18,050,000 (to ensure the dispatch of energy) and US\$12,587,500 (to guarantee commercial authorization of the relevant stage on the committed date) under the PPA for Los Teros I, (iv) US\$12,500,000 under the PPA for Los Teros II, and (v) US\$3,465,000 under the PPA for Cañadón León. A penalty is applied for breach of the relevant guaranteed obligation, which, if not paid, enables CAMMESA to execute the corresponding guarantee. Each of these PPAs will be fully terminated if the commercial authorization is not obtained within a period of 180 days as of the committed date, without prejudice to the execution of the guarantee by CAMMESA. For more information about our commitments and guarantees, see note 23 to our Audited Annual Financial Statements.

### ***Capital Expenditures***

The following table shows our capital expenditures for each activity for three-month period ended on March 31, 2019 and fiscal years 2018 and 2017.

	<b>For three-month period ended March 31,</b>		<b>For the year ended December 31,</b>			
	<b>2019</b>		<b>2018</b>		<b>2017</b>	
	<b>(in thousands of Ps., except percentage)</b>					
<b>Capital Expenditures</b>						
<b>Energy</b>						
Power plants and wind farms .....	5,389,613	98.89%	9,119,227	92.32%	2,620,026	95.77%
Materials and spare parts .....	48,695	0.89%	736,145	7.45%	100,335	3.67%
Other .....	11,877	0.22%	22,638	0.23%	4,688	0.17%
<b>Ramos Area .....</b>	-	-	0	0%	10,662	0.39%
<b>Total .....</b>	<b>5,450,185</b>	<b>100%</b>	<b>9,878,010</b>	<b>100%</b>	<b>2,735,711</b>	<b>100%</b>

### ***Divestments***

On February 2, 2018, we sold and transferred to YPF our 27% equity interest held in the Ramos Area with operations in the province of Salta. In addition, on March 1, 2018, we assigned and transferred to YPF the 10% equity interest held in CDS.

### **Off-balance Sheet Agreements**

We do not have any material off-balance sheet agreements.



### ***Qualitative and Quantitative Information about Market Risk***

Below is our quantitative and qualitative information on financial instruments to which we are a party as of December 31, 2018, and from which we may derive gains or incur losses due to changes in the market, interest rates or foreign exchange rates. We do not hold any derivative or other financial instruments for speculative trading purposes.

This information contains forward-looking statements that are subject to risks and uncertainties. Actual results could significantly vary as a result of a number of factors including those set forth in “Risk Factors.” For more information, see note 4 to our Audited Annual Financial Statements.

#### *Foreign currency exposure*

The value of financial assets and liabilities denominated in a currency different from our functional currency is subject to variations resulting from fluctuations in exchange rates. We have defined the U.S. dollar as our functional currency. Since our functional currency is the U.S. dollar, the currency that generates the greatest exposure is the Argentine peso.

The effect of changes in the U.S. dollar exchange rate on U.S. dollar currency positions have no impact on the exchange difference recorded in the statements of comprehensive income included in our Financial Statements, but affect the value of our assets and liabilities remeasured in pesos as a consequence of devaluation and considering our reporting currency (pesos). This is because all of our revenues are denominated in U.S. dollars as are more than 50% of our costs.

#### *Interest rate exposure*

We are exposed to risks associated with fluctuations in interest rates on loans and investments. Changes in interest rates may affect the interest income or expenses derived from financial assets and liabilities tied to a variable interest rate. Additionally, the fair value of financial assets and liabilities that accrue interests based on fixed interest rates may also be affected.

The fixed and variable rate financial loans represent 22% and 78%, respectively, of the total loans as of March 31, 2019, and 22% and 78%, respectively, of the total loans as of December 31, 2018, and include financial loans with local and international entities. The portion of the loan subject to the variable interest rate, is mainly exposed to the fluctuations in Libor.

Our financial assets mainly include, in addition to trade receivables, which have low exposure to interest rate risk, bank deposits, fixed-interest deposits and investments in mutual funds such as “money market” or short-term fixed interest rate instruments.

Our strategy to hedge interest rate risk is based on placing funds at a variable interest rate, which partially offset financial loans at a variable interest rate, as well as using cash flow hedging.

## THE ARGENTINE ELECTRIC POWER SECTOR

*The following is a summary of certain matters relating to the electric power industry in Argentina, including provisions of Argentine laws and regulations applicable to the electric power industry and to us. This summary is not intended to constitute a complete analysis of all laws and regulations applicable to the electric power industry. Investors are advised to review the summary of such laws and regulations published by the current SGE ([www.argentina.gob.ar/Energía](http://www.argentina.gob.ar/Energía)), CAMMESA ([www.cammesa.com.ar](http://www.cammesa.com.ar)), and ENRE ([www.enre.gob.ar](http://www.enre.gob.ar)) and to consult their respective business and legal advisors for a more detailed analysis. None of the information on or connected to such websites is incorporated by reference into this offering memorandum.*

### History

During the majority of the second half of the 20th century, the assets and operations of the Argentine electric power sector were controlled by the Argentine government. In 1990, virtually all the electric power installed in Argentina was controlled by the public sector (97% of total generation). By 1992, the regulatory framework of the electric power sector was reformed, deregulated and privatized both in a federal and a provincial level. The Argentine government had assumed responsibility for the regulation of the industry at the national level and controlled all the national electric power companies. As part of the economic plan adopted by former President Carlos Menem, the Argentine government undertook an extensive privatization program of all major state-owned industries, including those in the electric power generation, transmission and distribution sectors. Argentine Law No. 23,696 passed in 1989 (the “Federal Reform Law”) declared a state of emergency for all public services and authorized the Argentine government to reorganize and privatize public companies. The privatization had two ultimate objectives: first, to reduce tariffs and improve service quality through free competition in the market, and second, to avoid the concentration of control of each of the three subsectors of the market in a small group of participants and thereby reduce their ability to fix prices. Separate limitations and restrictions for each subsector were imposed in order to reach these goals. In accordance with the Federal Reform Law, Decree No. 634/1991 established guidelines for the decentralization of the electric power industry, for the basic structure of the electric power market, and for the participation of private sector companies in the generation, transmission, distribution and administration subsectors.

### General Overview of Legal Framework

#### *Key Statutes and Complementary Regulations*

The body of rules that constitutes the basic regulatory framework of the Argentine electric power sector currently in force includes Law No. 15,336, enacted on September 20, 1960, as amended by Law No. 24,065, passed on December 19, 1991, partially promulgated by Decree No. 13/92, and regulated by Decree No. 1398/92 and Decree No. 186/95 (collectively, the “Regulatory Framework”). Law No. 24,065 implemented privatizations of government-owned companies in the electric power sector and separated the industry vertically into four categories: generation, transmission, distribution and demand, and it also provided for the organization of the WEM (described in greater detail below) based on the guidelines set forth in Decree No. 634/91. In its Article 4, Law No. 24,065 and its regulation –Decree No. 1,398/1992– recognize the electric generators as one of the actors of the WEM. Every company must obtain the corresponding authorization (in compliance with the “Procedures for the Programming of the Operation, the Dispatch of Loads and the Calculation of Prices”, approved by Resolution No. 61/92 of the former Secretariat of Electric Energy of the former Ministry of Economy, Works and Public Services, as amended and supplemented, the “Procedures”) from the Enforcement Authority (as such term is defined below) to act as a WEM agent as a generator, co-generator, self-generator, transmission company, distributor or large user). Decree No. 186/95 also created the notion of “participant,” among which it is worth mentioning the “trader,” which is defined as a company that is not a WEM agent but trades electric power in bulk.

#### *Ente Nacional Regulador de la Electricidad (ENRE)*

Law No. 24,065 also created the ENRE as a decentralized and autonomous entity within the scope of the former Secretariat of Energy), the main duties of which are as follows: (a) enforcing the Regulatory Framework and controlling the rendering of public services and the performance of the obligations set forth in the concession contracts at a national level; (b) issuing the regulations applicable to the WEM agents; (c) setting forth the basis for calculation of tariffs and approving the tariff schedules of transmission and distribution companies holding national concessions;

(d) authorizing electrical conduit easements; and (e) authorizing the construction of new facilities. Also, Law No. 24,065 has entrusted the ENRE with a jurisdictional activity so any dispute arising between WEM agents should be subject to prior compulsory jurisdiction of the ENRE (subject to further judicial review).

Pursuant to Decree No. 258/16, the executive branch appointed the new interim members of the ENRE's board of directors, ratifying the appointment of the President and appointed the Vice President, Second and Third Voting Member, and ordered the former MEyM to put in place an open call (*convocatoria abierta*) to select the members of the ENRE's board of directors.

The First Member of the Board of the ENRE was appointed by the Decree No. 433/2016. In compliance with the provisions of Decree No. 258/2016, through Resolution No. 204-E/2016 the former MEyM called for a professional antecedent contest for the election and appointment of the President, Vice President and First Member of the ENRE Board of Directors through Resolution No. 204-E/2016.

Furthermore, to determine the profiles of the candidates for the office of President of the ENRE's board of directors, in order to comply with the provisions set forth in section 58 of Law No. 24,065 and section 54 of Law No. 24,076, who shall be the same as those approved during the open call set forth by Resolution No. 204-E/2016 of such Ministry, a contest was called for the position of President of the Board through the Resolution No. 205-E/2017. Finally, the Decree No. 84/2018 designated the President, Vice President and Second and Third Voting Member of the ENRE Board.

#### ***Enforcement Authority of Law No. 15,336 and 24,065***

The Argentine President appointed the former SEE as the applicable authority for the enforcement of Laws 15,336 and 24,065. Decrees No. 801/2018 and 802/2018, appointed the SGE as the enforcement authority of Laws 15,336 and 24,065 which comprise the regulatory framework of the electric power sector (the "Enforcement Authority"). Regarding power electric dispatch, Law 24,065 and its regulatory decree, empowered the Enforcement Authority to rule the Dispatch Organization (Organismo Encargado del Despacho-OED) (article 35) and dictate the rules for the dispatch of power electricity in the market (article 36).

Since the enactment of Decree No. 13/2015, the former MEyM has absorbed the functions of the former Secretariat of Energy and the former Mining Secretariat, both dependent to the former Ministry of Federal Planning, Public Investment and Services, and of its decentralized and deconcentrated bodies. The main tasks of the Enforcement Authority are as follows:

- to participate in the drafting and implementation of national energy policies;
- to enforce the laws governing the development of the activities within its scope of competence;
- to participate in the drafting of policies and regulations governing public services within the scope of its competence;
- to oversee the entities and agencies governing works and public service concessionaries;
- to engage in drafting regulations concerning licenses issued by the federal government or the provinces for public services within the scope of its competence;
- to oversee the regulatory entities and agencies of privatized areas or areas operating under concessions within the scope of its competence; and
- to enforce the Regulatory Framework and to oversee the regulations governing tariffs, fees, duties and taxes.

Pursuant to Resolution No. 25/16, the former MEyM has delegated some of its duties to the Secretariat of Electric Energy: amending the Regulation on Access to Existing Capacity and Expansion of the Electric Power

Transportation System; regulating the International Interconnection Transmission System (the “IITS”); amending the rules governing the Procedures; defining power and energy amounts and other technical parameters that distributors and large users (users whose consumption exceeds the maximum consumption level set forth by the Regulatory Framework, “large users”) are required to meet to access the WEM and authorizing the entry of new players to the WEM; authorizing electric power imports and exports; rendering final administrative decisions with respect to appeals brought against the ENRE’s resolutions, which are the last administrative remedies that can be filed in order to review the ENRE’s resolutions (the next step is a judicial appeal); exercising the duties of the former MEyM within the Federal Electricity Council; and administering the Provinces’ Special Fund for Electricity Development created by Section 33 of Law No. 15,336.

The former MEyM delegated to the Secretariat of Electric Energy the duties of the former Secretariat of Electric Energy pursuant to Sections 35, 36 and 37 of Law No. 24,065, through Resolution No. 6/16; representing the state-owned equity interest in CAMMESA; defining the rules governing CAMMESA ensuring transparency and equity; determining the overall operating and maintenance costs that would allow fully or partially state-owned generation and transportation companies to maintain service quality, continuity and safety; and administering the Stabilization Fund.

In order to address the multiplicity of sectorial issues that led to the declaration of the state of emergency with respect to the national electrical system through the Resolution MEyM 25/16, the former MEyM empowered the SEE of the former MEyM with the following functions: a) Modify the Regulation on Access to Existing Capacity and Expansion of the Electric Power Transportation System and the Regulation for Connection and Use of the Electric Power Transportation System, in the terms of Articles 12 and 13 of Decree No. 2,743 dated December 29, 1992; b) regulate the international interconnection electric power transport in accordance with Articles 6 subsection b) and 7 of Decree No. 974 dated September 18, 1997; c) modify the regulations contained in the Procedures; d) define the power, energy and other technical parameters that must be met by the distributors and large users for the incorporation into the WEM in the terms of Article 3 of Decree No. 186/95 and of Article 10 of Decree No. 1398/92 and to authorize the incorporation of new WEM actors; e) To dictate the legal framework for operation and contracting within the WEM; f) Authorize the importation and exportation of electric energy; g) Resolve appeals filed against the acts issued by the ENRE as final recourse and exhausting the administrative procedure in terms of Article 76 of Law No. 24,065 and its regulations approved by Decree No. 1398 dated August 6, 1992; h) Exercise the functions granted by Law No. 15,336 to the former MEyM within the Federal Council of Electric Energy (CFEE); and i) Manage the Federal Special Electricity Development Fund in accordance with the guidelines established by Law No. 15,336.

Through Resolution MEyM 98/18, the former MEyM modified Resolution MEyM No. 64/18 and established that the competences delegated to the former Secretariat of Energy by Resolutions No. 6/16 and 25/2016, other than what is established in its article 1, clause f), are under the responsibility of the former Undersecretariat of Electric Energy.

Decree No. 801/2018 dissolved the Ministry of Energy and the Ministry of Economy assumed its functions, taking control of the preparation, proposal and enforcement of the federal policy regarding electric power, fuel regime, tax structure and technological research and development.

Decree No. 802/2018 created the position of Government Secretary of Energy, reporting to the Ministry of Economy.

Decree No. 174/2018, as amended by Decrees No. 958/2018 and No. 105/2019, set the purpose of the SGE, who exercises the duties of the Enforcement Authority, applies the laws that govern the energy business and acts as awarding authority in connection with the awards and authorizations set forth in such laws; exercises, as regards energy, controlling powers with respect to such controlling entities or agencies of privatized areas or areas under concession within its jurisdiction, enforces the applicable regulatory frameworks, addresses tariffs, fees, duties and taxes, monitors the performance of the ENRE, the *Ente Nacional Regulador del Gas* (Argentine National Electricity Regulator, ENARGAS), the *Unidad Especial Sistema de Transmisión Yacyretá* (Yacyretá Special Transmission System, UESTY) and the *Comisión Nacional de Energía Atómica* (Argentine National Atomic Energy Commission, CONEA), among other powers.

Decree No. 174/2018 also established the duties of the Secretariat of Renewable Resources and Electricity Market, which is involved in the preparation of sectorial proposals and the domestic policy on renewable resources and electric power, as well as in the control of the execution thereof. Moreover, the Secretariat of Renewable Resources and Electricity Market participates in the formulation of the tariff policy, the public service of transmission and distribution of electric power, the short and mid-term management of the wholesale electricity market, the incorporation of new players, and the definition of the operation and contracting patterns within the scope of said market. It also assists in the procedures for the authorization to import and export electric power, promotes the use of new energy sources, the addition of conventional hydroelectric power supply and the research applied to these fields, and it participates in the evaluation of the resources available for the use of energy and in all aspects related to the development of electric power generation, through the use of renewable energy sources in all stages, as well as in the execution of actions related to the applicable legal framework, among others.

On January 28, 2019, with the purpose of achieving celerity and efficiency in the exercise of the competencies attributed by legislation to the SGE, and taking into account the principle of specialty in administrative functions, Resolution No. 1/2019 (published in the Official Gazette on January 14, 2019) was enacted by the SGE. By means of this resolution, the following powers were delegated to the Undersecretariat of Renewable Energy and Energy Efficiency: promulgate the necessary acts and clarify the supplementary rules in connection with the Procedure to Obtain the Certificate of Inclusion in the Renewable Energy Legal Framework and the Procedure to Control Investments and the Use of Tax Benefits; add the exhibits to the FODER Agreement created by section 7 of Law No. 27,191; qualify the bids and award the agreements under the RenovAr Program; exercise the powers of the SGE, in its capacity as FODER Enforcement Authority, as set forth in laws No. 26,190 and 27,191, and Decree No. 531 dated March 30, 2016, as amended and supplemented; subdelegate upon the *Dirección Nacional de Energías Renovables* (Renewable Energy Federal Agency) the execution of the FODER Trust Adhesion Agreements to be entered into with the FODER trustee and the beneficiaries awarded in the different RenovAr Program rounds; determine the documents to be submitted as regards the filing with the *Registro Nacional de Proyectos de Generación de Energía Eléctrica de Fuente Renovable* (National Register for Renewable Energy Power Generation, or “RENPER”) created by section 9 of Resolution No. 281/2017 dated August 18, 2017 and provide for the filing of the respective projects; issue the clarifying and supplementary rules of Resolution No. 281/2017; set forth the maximum amount of tax benefits to be awarded by megawatt for each technology, in accordance with the provisions set forth in section 4 of the exhibit to such Resolution No. 281/2017; authorize changes in the strategic partner of the companies that are the owners of the projects awarded during the different RenovAr Program rounds; and approve the relocation requests regarding the renewable source electric power generation projects under the RenovAr Program; among other powers.

### ***Wholesale Electricity Market (WEM)***

Pursuant to Section 35 of Law No. 24,065 and other regulations, the *Despacho Nacional de Cargas* (National Dispatch Board, “DNCD”) must be structured as a corporation. CAMMESA was created for such purpose (Decree No. 1,192/92) and to coordinate the technical and administrative supply and demand of electric power within a real-time operation system, centralizing and processing information produced by the WEM agents. CAMMESA also acts as a collection entity for all WEM agents.

The WEM consists of:

- a term market, where contractual quantities, prices and conditions are freely agreed upon among sellers and buyers;
- a spot market, where prices are established on an hourly basis based on the economic production cost, represented by the short-term marginal cost measured at the system’s load center (market node); and
- a quarterly stabilization system of spot market prices, intended for the purchases of electric power by distributors.

### ***Procedures for the Programming of Operation, Dispatch and Price Calculation***

For the purposes of implementing the provisions set forth in the Regulatory Framework, a set of regulatory provisions were issued, through former Secretariat of Electric Energy Resolution No. 61 of April 29, 1992, which are referred to as the “Procedures for the Programming of Operation, Dispatch and Price Calculation” (the “Procedures”). The Procedures have been amended, supplemented and extended by subsequent resolutions issued by the former Secretariat of Electric Energy.

### ***Compañía Administradora del Mercado Mayorista Eléctrico S.A. (CAMMESA)***

Pursuant to Section 35 of Law No. 24,065, the technical dispatch of the SADI shall be in charge of the DNCD, entrusted with the technical and administrative coordination of the electric power supply and demand within a real-time operation system, centralizing and processing information produced by the WEM agents. Therefore, CAMMESA was created through Decree No. 1192/1992; which decree also approved its corporate bylaws.

CAMMESA is a not-for-profit corporation. Its shareholders each hold 20% stakes and are as follows: the Argentine government and the four associations representing the different segments of the electric power sector (generation, transmission, distribution and large users).

CAMMESA is in charge of:

- managing the SADI in accordance with the Regulatory Framework, which includes:
- determining the technical and economic dispatch of electric power (including determining the schedule of production of all generation plants of a power system to balance the production with the demand) at the SADI;
- maximizing system security and the quality of electric power supplied;
- minimizing wholesale prices in the spot market;
- planning energy capacity requirements and optimizing energy use in accordance with the rules set forth periodically by the SGE;
- monitoring the operation of the term market and administering the technical dispatch of electric power under the agreements entered into in that market;
- acting as agent of the various WEM participants;
- purchasing and selling electric power from or to other countries by performing the relevant import/export transactions within the framework of existing agreements between Argentina and bordering countries and/or among WEM agents and third parties from bordering countries; and
- carrying out the commercial administration and dispatch of fuels for the WEM generation plants.

In addition to the responsibilities mentioned above, under Resolution No. 95/2013 of the former SEE, CAMMESA has temporarily been tasked with the role of acquiring and supplying the fuel for the electric power sold under Energía Base free of cost to the generators. However, at present, Resolution No. 70/18 of the SGE empowers WEM generator agents to acquire their own fuel to generate electric power, while the OED remains in charge of the commercial management and dispatch in the cases in which the WEM generator agents are unable or unwilling to exercise such power.

Furthermore, Resolution No. 61/92 of the former Secretariat of Energy set forth that the expenses incurred by the OED, are to be budgeted on a semi-annual basis, broken down by month, which budget includes all the

necessary items, including both the direct expenses and the indirect expenses and investments. The reimbursement of the budgeted monthly expenses shall be borne by all the market agents.

The OED must submit said budget on or before March 1 and September 1 of each year to the companies that participate in the WEM. These companies shall then have 15 calendar days to submit objections and/or suggest amendments. By no later than April 1 and October 1, respectively, the OED shall submit the budget, together with any objections raised, to the Enforcement Authority.

The budget shall be allocated monthly among each company that participates in the WEM in proportion to the transaction volume for the relevant month (as purchaser or seller) including the transactions carried out in the Term Market.

Jointly with the quarterly reviews of the seasonal scheduling, the OED may propose budget adjustments, subject to the abovementioned procedure.

If any surplus arises after the execution of the budget in any seasonal period, such surplus shall be included in the budget for the following period.

### **Provincial Regulatory Powers**

Provinces can (and do) regulate the electrical system within their territories, and are enforcement authorities in charge of granting and controlling electric power distribution concessions within their territories. Nonetheless, if a provincial electric power market participant is connected to the SADI, it must also comply with federal regulations. In general terms, provinces have followed federal regulatory guidelines and have established similar regulatory institutions. In addition, isolated provincial electric power systems are very rare, and most provincial market participants are connected to the SADI and buy and sell electric power in the WEM, which falls within the regulatory powers of the Argentine government.

### **Structure of the Industry**

#### ***Generation and the WEM***

According to Law No. 24,065, electric power generation is classified as an activity of public interest associated with the provision of the public service of transmission and distribution of electric power, but conducted within the framework of a competitive market.

As a result of the privatization and incorporation of new market players, the generation sector, even after a consolidation process that took place over the past few years, has a competitive structure with at least four major companies of similar size: (i) Central Puerto S.A.; (ii) Enel Argentina S.A. (which includes Enel Generación Costanera, El Chocón and Central Dock Sud plants); (iii) Pampa Energía S.A. (which includes Central Térmica Güemes, Central Térmica Loma La Lata, Inversora Piedra Buena S.A., Inversora Diamante S.A., CTG and Inversora Nihuales and assets acquired from Petrobras Argentina S.A.); (iv) AES Argentina Generación S.A. (which includes Central Térmica San Nicolás S.A., Hidroeléctrica Alicurá S.A., and Central Termoeléctrica Guillermo Brown S.A.). In addition, a significant portion of the generation sector is controlled by state-owned and state-controlled companies (*e.g.*, Yacyretá, Salto Grande, IEASA, Atucha and Embalse) and other private sector generators (*e.g.*, YPF Luz, Orazul Group, Albanesi S.A., Capex S.A. and Genneia S.A.).

Thermal electric power generators (*i.e.*, generation using natural gas, liquid fuels derived from oil, such as gasoil and fuel oil or coal) do not need a concession granted by the government to operate, whereas hydroelectric power generators do need a concession granted by the government to be able to use water sources. Typical terms included in concession agreements include the right to use water resources and facilities for a fixed amount of time (*e.g.*, 30 years), in cases where the dam is owned by the Argentine government or an Argentine provincial government, and the option to extend or renew the concession period for a fixed number of years. Usually, the concessionaire must make a one-time initial payment to the Argentine government or an Argentine provincial government in exchange for the rights granted in the concession and periodically must pay a fee and/or royalty to the respective provincial

government where the river is located in exchange for the use of this water resource. Normally, these periodic fees vary according to the amount of energy generated.

Within the WEM, the performance of a Generator is: (a) physical, as responsible for the central operation; (b) commercial, as a seller in the Spot Market and in the Market Term of its power and power production capacity, having to pay the debts incurred in the WEM due to this commercialization, such as the purchases made in the Spot Market to satisfy the sales committed in the Term Market, the transmission expenses, and the OED expense charge, and receiving the profits resulting out of such commercialization.

### ***Electricity Dispatch and Spot Market Pricing***

#### ***(i) Original Design***

According to the Regulatory Framework, an electric power generators' remuneration must be a function of two components: (i) a variable component, based on quantity of energy sold in the market, and (ii) a fixed component that aims to remunerate the generator for each MW of capacity of its units available per hour in the WEM, regardless of the consumption of the electric power generated by such units. The value of the fixed component depends on, among other things, the connection node to which the unit connects to the SADI.

Based on the original design, electric power must be traded at prices reflecting supply and demand. CAMMESA must dispatch the available power units based on the variable costs of production determined by the generation agents, either based on the cost of fuel or the price of water determined, dispatching the most efficient power units first. The spot market price must be determined by CAMMESA on an hourly basis at a specific geographic location, referred to as the "market node," which is located in the system's load center in Ezeiza, Province of Buenos Aires. The energy price consists of a value referred to as the "marginal system price" or "market price," and must represent the economic cost of generating the next MWh to satisfy an increase in demand at the same value. The seasonal price fixing system must be directly related to the quarterly average prices of the spot market.

CAMMESA must keep operating costs low and optimize prices. Pursuant to the regulations and legal procedures enforced, CAMMESA must apply optimization models in accordance with applicable regulations, based on weather estimates, dam levels, rain forecasts for the following months and the availability of nuclear plants and thermal machines. These optimization models are aimed at keeping operating costs at the lowest possible level while satisfying the expected daily demand for electric power.

To meet electric power demand, CAMMESA must organize and coordinate the electric power dispatch of generators by prioritizing power units with a lower variable production cost, followed by those with a higher variable production cost, until all electric power demand has been satisfied. Generators must inform CAMMESA of the thermal generation plants' variable production costs, which depend on the availability of different types of fuels provided by CAMMESA (*e.g.*, natural gas, fuel oil and gasoil).

With respect to demand, CAMMESA must calculate the typical hourly consumption curves and take into account the limitations of the transmission grid, the needs of distributors, large users and self-generators that purchase energy in the WEM, and demand from interconnected importing countries that only receive energy if there is excess supply in Argentina.

As a result of this process, CAMMESA must define an optimal market price, which results from adding the variable cost of transmission from the generator's connection point to the market node to the accepted variable production cost.

The procedure described above must be used to project the future needs of the SADI and WEM. However, often projections and actual market conditions differ, which creates differences between purchases by distributors at seasonal prices and payments to generators for energy sales at the spot price.



***(ii) Measures adopted during the public emergency; January 2002 – December 2017***

Since the sanction of the Public Emergency Law No. 25.561 on January 6, 2002, a series of temporary provisions amended the original mechanism for the determination of prices in the WEM.

In 2002, the former Secretariat of Energy issued Resolution No. 146/2002 which set forth a procedure to advance the financing of major or extraordinary maintenance works for Generation and/or Energy Transmission Systems equipment, in order to surpass a crisis that might affect the timely maintenance as a result of a financing deficit. In this sense, the resolution enabled any generator and/or transmission company that needed to carry out major or extraordinary maintenance projects and required funds to bear such projects but had financial difficulties to obtain such funding, to request a loan for a portion of such expenses, subject to the availability of funds and to the satisfaction of the conditions set forth to such effect, both in the case of generators and transmission companies. Under this mechanism, the repayment of the amounts borrowed by the WEM agents was secured by the assignment of their receivables in the WEM Spot Market, to the extent of the aggregate repayment of the loan. The framework set forth by this resolution would be effective during the emergency declared by Law No. 25,561 or until such time as the former Secretariat of Energy considered that the causes that gave rise to such framework no longer subsisted.

In 2003, the former Secretariat of Energy issued Resolution SE 240/03 approving the “Method to fix prices in the Wholesale Electric Market and in the Patagonia System Wholesale Electric Market.” In 2006, the former Secretariat of Energy issued Resolution SE No. 1281/06 and created the Energía Plus Program, in an effort to respond to the sustained increase in energy demand and to foster new private sector interested parties to invest fresh capital into the energy sector in order to generate new energy sources. The resolution provided that: (i) The energy available in the market will be used primarily to serve residential customers, public lighting, public entities and industrial and commercial users whose energy demand is at or below 300 kW and that have not entered into term contracts; (ii) GUMAs, GUMEs and large customers of distribution companies (in all cases with consumption equal or higher than 300 kilowatts) must satisfy any consumption in excess of their base demand with energy from the Energía Plus service, consisting of the supply of additional energy generation from new generators and generation agents, co-generators or self-generators that are not WEM Agents or who, as of the date of publication of the resolution, were not interconnected to the WEM. The price payable by large users for excess demand, if not previously contracted for under the Energía Plus program, was originally set to be equal to the marginal cost of operation.

In 2007, the former Secretariat of Energy issued Resolution SE No. 220/2007 (published in the Official Gazette on January 22, 2007) which allowed the execution of supply agreements between the WEM and the *ofertas de disponibilidad garantizada* (guaranteed availability offers) offered by generators, co-generators and self-generators who as of such date were not WEM agents. This resolution was adopted to foster the investments necessary to guarantee the long-term supply of energy and was mainly intended to boost the addition of new power energy supply, by establishing economic rules and setting forth the actions to be taken by the WEM agents, or those intending to become agents, to install new generation supply.

In 2013, the former Secretariat of Energy issued Resolution No. 95/13 which set forth that own fuel costs shall be recorded based on the applicable reference price, the recorded freight, the cost associated with the Transportation and Distribution of Natural Gas, and the related taxes and duties, provided that the conditions set forth therein are satisfied. To optimize and minimize the costs of the supply of fuels to the WEM generation plants, the commercial management and dispatch of fuels shall be centralized in the Dispatch Organization (section 8).

In 2014, the former Secretariat of Energy extended the application of Section 8 of Resolution No. 95/2013, to the WEM generators, co-generators and self-generators, including the power and/or electric energy produced by the WEM generators, co-generators and self-generators and committed under agreements regulated by the former Secretariat of Energy, through resolutions SE No. 1193/ 2005, No. 220/2007 and No. 1836/2007, as well as any other kind of electric power supply agreement under a differential remuneration regime set forth by the former Secretariat of Energy reporting to the former Ministry of Federal Planning, Public Investment and Services, except for the agreements under Resolution No. 1281 dated September 4, 2006 issued by the former Secretariat of Energy. To administer the transactional conditions of these agreements, coverage thereof shall take into account machine availability regardless of fuel (Resolution No. 529/2014).

Therefore, the remuneration systems established in the WEM since 2003 involved the progressive adoption of regulatory decisions outside the criterion underlying Law No. 24,065, consisting in ensure the sufficiency and quality of supply under the defined conditions, at the lowest possible cost to the Argentine Electric System.

The abandonment of reasonableness and efficiency criteria in the definition of WEM prices has increased the cost of adequately supplying demand, distorting economic signals and thus discouraging private investment of risk in electric power generation.

In 2015, the Argentine government enacted Decree No. 134/2015, declaring a state of emergency with respect to the national electrical sector until December 31, 2017. Pursuant to this decree, the former MEyM was entrusted with the duties of developing and putting in place an action plan in connection with the electricity generation, transmission and distribution segments under national jurisdiction in order to improve the quality and security of electricity supply and guarantee the provision of this public service under suitable technical and economic conditions.

In 2016, the former SEE issued Resolution No. 21/16 calling for interested parties to submit bids of new thermal generation capacity and associated energy production. The resolution provided that any agent whose offer was accepted would enter into a wholesale demand agreement to sell the available electric power and associated energy in the WEM, to be entered into initially by CAMMESA and then assigned to the distributor agents and large users of the WEM. The guidelines of this agreement are set forth in Resolution No. 21. CAMMESA must certify in favor of the seller agent the proportional share that large users and distributors must pay in consideration for the electric power consumed, for purposes of its collection. Through Resolution No. 155/2016, the former SEE announced the awardees under this bidding process, and authorized CAMMESA to start the negotiations to enter into the wholesale demand agreements with these companies. Due to the national electrical sector emergency, in that same year, the former Secretariat of Energy issued Resolution No. 22/16 setting forth adjustments to the remuneration scheme applicable to generators, for the sole purpose of temporarily guaranteeing the supply of the electric power in Argentina until the entry into force of the regulatory measures for the normalization of the WEM.

In 2017, the former Secretariat of Electric Energy issued Resolution SEE No. 19/17 (published in the Official Gazette on February 2, 2017), empowering electric power generators, co-generators and self-generators acting as agents in the WEM and which operate conventional thermal power plants to make *ofertas de disponibilidad garantizada* (guaranteed availability offers) in the WEM. Pursuant to these offers, these generation companies may commit specific capacity and power output, provided that such capacity and energy had not been committed under PPAs entered into in accordance with Resolutions No. 1193/05, 1281/06, 220/07, 1836/07 and 200/09 of the former Secretariat of Energy, Resolution No. 21 of the former Secretariat of Electric Energy, and Resolutions No. 136/16 and 213/16 of the former MEyM, as well as PPAs subject to a differential remuneration scheme established or authorized by the former MEyM. The offers must be accepted by CAMMESA (acting on behalf of the WEM agents that demand electric power), which entity will be the purchaser of the power under the *compromisos de disponibilidad garantizada* (guaranteed availability agreements). Resolution No. 19/17 established that such agreements may be assigned to electricity distribution companies and large users of the WEM once the state of emergency of the electric power sector in Argentina has ended (according to Decree No. 134/2015, such emergency was declared until December 31, 2017). Generator Agents fully or wholly-owned by the Argentine government were excluded from the scope of Resolution No. 19/17. The term of the guaranteed availability agreements is three years, and their general terms and conditions have been established in Resolution No. 19/17 of the former Secretariat of Electric Energy. The remuneration in favor of the generator was calculated in U.S. dollars pursuant to the formulas and values set forth in the aforementioned resolution, and comprised of (i) a price for the monthly capacity availability, and (ii) a price for the power generated and operated.

In the same year, the former Secretariat of Electric Energy issued Resolution No. 287/17, whereby it made an Open Invitation to Tender Bids (*Convocatoria Abierta a Interesados* or “CAI”) for the sale of electricity produced as a result of the installation of new generation capacity that used the following technology: a) closing to combined cycle or b) cogeneration, with availability commitment to satisfy the WEM demand. The bidders whose offers are selected shall enter into Wholesale Demand Agreements with the WEM users, in accordance with the terms set forth under the regulatory framework in force.

**(iii) Current remuneration scheme of Generators.**

Resolution No. 70/18 of the SGE replaced section 8 of Resolution No. 95/13, to readjust the conditions applicable to the supply of fuel to power plants, empowering WEM generators, co-generators and self-generators to acquire their own fuel for the generation of electric power, without altering the commitments assumed by them under the supply agreements. This resolution also set forth that the OED will remain in charge of the commercial management and fuel dispatch for WEM generators that are unable or unwilling to exercise said power to acquire their own fuel.

Through Resolution No. 1/2019, the Undersecretariat of Renewable Resources and Electricity Market (published in the Official Gazette on March 1, 2019), implemented new temporary remuneration schemes for Technical Qualified Generation, and Hydraulic Qualified Generation, and designed a new remuneration methodology for the Binational Hydraulic Power Plants Yacretá and Salto Grande.

Such resolution also set forth a new guaranteed power availability schedule and provided that these new provisions were to become effective as from March 1, 2019.

Resolution No. 1/2019 was issued under the powers set forth in Resolution SGE No. 65/2019 and abrogated the regime set forth by Resolution No. 19/2017 of the former SEE.

This new resolution defines the “Qualified Generators” (*Generadores Habilitados*, or “GH”) as all the WEM generators, co-generators and self-generators, except for the generation of the binational hydroelectric power plants, nuclear generation and the generators, co-generators and self-generators with committed capacity under centralized agreements to supply the WEM demand.

Resolution No. 1/2019 also established the “Guaranteed Offered Availability” scheme (*Disponibilidad Garantizada Ofrecida*, or “DIGO”) as the power made available by a Thermal Qualified Generator (*Generador Habilitado Térmico*, or “GHT”), and committed by it with respect to each generation unit and each DIGO remuneration period. This availability shall be committed taking into account the typical temperature conditions of the place and its base dispatch fuel. According to Resolution No. 1/2019, the power and energy already committed under an agreement entered into under a differential regime cannot be committed under the DIGO scheme.

Resolution No. 1/2019 set forth the following DIGO requirement periods:

- (i) Summer period: December – January – February;
- (ii) Winter period: June – July – August;
- (iii) Remaining period: March – April – May and September – October – November.

Furthermore, GHTs may also take the DIGO commitment during the periods informed by CAMESA.

*Thermal generation*

As regards the remuneration scheme applicable to thermal qualified generation, it shall be broken down into a payment for monthly available power and another payment for generated power and operated power. The remuneration of power availability is subdivided into a minimum price associated with the real available power (*disponibilidad real de potencia*, or “DRP”) and a price per guaranteed power provided that a certain amount of guaranteed offered power (*potencia garantizada ofrecida*, or “PGO”) is met. The remuneration of the power depends on the generation equipment use factor. The energy remuneration is defined by the sum of two components: one based on the generated energy and another related to the operated energy (associated with the rotating power in each hour).

The hourly volume of operated energy must be in accordance with the optimum dispatch to satisfy the allocated energy and reserves. The energy remuneration of the generator is defined at its node.

In the event that the GHs choose to manage the fuel by themselves, they shall provide a statement of the commitment undertaken by them in such regard. Such statement should be made in accordance with the procedure in force for fortnightly statements of production variable cost (*costo variable de producción*, or “CVP”). Furthermore, the resolution also set forth that the available units that at the time of the request do not have the committed fuel shall be considered to be partially available in terms of their real availability, and the variable components thereof shall be partially remunerated. As opposed to Resolution No. 19/2017, this resolution did not establish an increase in the remuneration for compliance with thermal efficiency goals.

The power base price (“PrecBasePot”) was defined to remunerate power at different values according to each technology and scale, as shown in the following table:

Technology/Scale	Power base price [US\$/MW-month]
Large CC P > 150 MW	3,050
Small CC P ≤ 150MW	3,400
Large VT P >100 MW	4,350
Small VT P ≤ 100MW	5,200
Large GT P >50 MW	3,550
Small GT P ≤ 50MW	4,600
Internal combustion motors	5,200

The resulting remuneration shall be the base value for power availability to be applied to such generators that do not declare DIGO.

The values for the PGO remuneration for each month defined above (DIGO Requirement Periods) were also fixed; a DIGO guaranteed power price (“PrecPotDIGO”) for all the GHs shall be acknowledged for the PGO remuneration in the following manner:

Period	DIGO guaranteed power price [US\$/MW-month]
Summer: December – January – February	7,000
Winter: June – July – August	7,000
Remaining period: March – April – May and September - October – November	5,500

As regards the use factor (“FU”), for each “n” month of economic operation, the FU shall be calculated for each “g” generation unit defined as:

$$FU_{gn} = \text{GenMovYear} / (\text{DRPg.n.avg} \times \text{Hs moving year})$$

Where:

DRPg.n.avg: Is the average DRP of the “g” generation unit for the moving year prior to the “n” month of issue of the DTE.

$$DRPg.n.avg (MW) = \frac{\sum_{\text{month } n-12}^{\text{month } n-1} (\text{DRPg.month} \times \text{kFM})}{12}$$

hs moving year: aggregate hours in the moving year prior to the “n” month of issue of the DTE.

kFM = hours of the month outside agreed maintenance works divided by the hours of the month.

GenMovYear: Is the aggregate generation of the “g” generation unit during the moving year prior to the “n” month of issue of the DTE.

As concerns the remuneration applicable to power availability, the following criteria were established:

**(a)** real power remuneration (DRP); the DRP is the average monthly availability applicable to the “m” month of each “g” generating machine that is not under scheduled maintenance; and it shall be calculated for the GHTs taking into account the hourly values recorded during the month. The calculation of the “m” month is made taking into account the values recorded during the month.

**(b)** power availability remuneration: the power monthly remuneration of a thermal generator shall be in proportion to its monthly availability, the FU of the generation unit and a price that shall be seasonal. The physical value is an average monthly power deducting the hours applicable to scheduled and agreed maintenance. Power unavailabilities to be considered in the determination of the average available power shall be those attributable to the Generator Agent’s own management.

DIGO unavailability of a generation unit derived from any own failure or due to the impossibility to use the fuel allocated in the economic dispatch, resulting in unavailability for economic dispatch purposes, is the responsibility of the GH and shall be treated as a forced unavailability.

Any generation unit that has elected the own fuel option for generation but does not have the fuel required for dispatch at the time of the request, shall be deemed to have an availability of 50% of the real availability.

**(c)** the remuneration applicable to the available power of generators that do not declare DIGO is based on the DRP of the month valued at the PrecBasePot [\$/MW-month]. The availability is assessed discounting the forced unavailable power and the scheduled or agreed maintenance works.

$$\text{REM BASE [$/month]} = \text{PrecBasePot} * \text{DRP [MW]} * \text{kFM}$$

Where:

kFM = hours of the month outside the agreed upon maintenance works/hours of the month.

**(d)** remuneration applicable to the guaranteed power offered by generators that declare DIGO;

The PGO remuneration is the remuneration of the available power (limited as a physical quantity to be computed in the DIGO) valued as the price PrecPotDIGO [\$/MW-month] in accordance with the following formula:

(i) If  $\text{DRP} \geq \text{DIGO}$

$$\text{REM DIGO [$/month]} = (\text{DRP} - \text{DIGO}) [\text{MW}] * \text{kFM} * \text{PrecMinPot} + \text{DIGO} [\text{MW}] * \text{kFM} * \text{PrecPotDIGO}$$

(ii) If  $\text{DRP} < \text{DIGO}$

$$\text{REM DIGO [$/month]} = \text{MAX} \{ \text{REM BASE}; \text{DRP} [\text{MW}] * \text{kFM} * \text{PrecPotDIGO} * \text{DRP} / \text{DIGO} \}$$

Where:

kFM = hours of the month outside agreed upon maintenance works/hours of the month.

**e)** Aggregate remuneration applicable to the power availability in the case of Generators that do not declare DIGO: the aggregate remuneration applicable to the power availability shall be calculated, in the case of generators that do not declare DIGO, exclusively in accordance with the provisions set forth in paragraph (c) and its application shall depend on the FU.

FU < 30%

REM TOT (\$/month) = REM BASE \* 0.730 %<= FU < 70%

REM TOT (\$/month) = REM BASE \* (FU \* 0.75 + 0.475)FU >= 70%

REM TOT (\$/month) = REM BASE

f) Aggregate remuneration applicable to power availability in the case of Generators that declare DIGO: the aggregate remuneration applicable to the power availability in the case of generators that declare DIGO is the sum of all the remunerations arising out of paragraph, as applicable, (d). item a) or (d). item b) defined above, and its application shall depend on the FU.

FU < 30%

REM TOT (\$/month) = REM DIGO \* 0.7

30 %<= FU < 70%

REM TOT (\$/month) = REM DIGO \* (FU \* 0.75 + 0.475)

FU >= 70%

REM TOT (\$/month) = REM DIGO

*Remuneration of Generated Power*

In the case of conventional thermal power generation, the following maximum variable non-fuel costs [CostOYMxFuel] set forth in the following table shall be recognized for the power delivered at each hour, per type of fuel consumed by the “g” generation unit:

Technology/Scale	[CostOYMxFuel]			
	Natural Gas [US\$/MWh]	Fuel/Oil GasOil [US\$/MWh]	Bio Fuel [US\$/MWh]	Mineral Coal [US\$/MWh]
Large CC P > 150 MW	4	7	10	
Small CC P ≤ 150MW	4	7	10	
Large VT P >100 MW	4	7	10	12
Small VT P ≤ 100MW	4	7	10	12
Large GT P >50 MW	4	7	10	
Small GT P ≤ 50MW	4	7	10	
Internal Combustion Motors	4	7	10	

Any generation unit that has selected the own fuel option for its generation but does not have the fuel for dispatch at the time of the request, shall lose its dispatch turn until, if necessary, the OED allocates it fuel for its operation. In this case, only 50% of the applicable non-fuel variable costs shall be remunerated.

*Remuneration of Operated Power*

Generators shall receive a monthly remuneration for the operated power, represented by the sum of the hourly power during the period, valued at 1.4 US\$/MWh for any type of fuel. The hourly volume of operated energy shall match optimal dispatch for purposes of complying with the allocated power and reserves.

#### ***(iv) Seasonal Price and Stabilization Fund***

Section 36 of Law No. 24,065 provides for two different prices in the Spot Market of the WEM: (a) an “hourly” price, received by the sellers and paid by part of the demand of the users that elect to supply themselves from the WEM; and (b) a “seasonal” price, payable by distribution companies, stabilized on a semi-annual basis through quarterly adjustments based on the hourly price estimated for the next period and the resources in the Stabilization Fund, which must be sufficient to absorb the difference between both “Spot” prices in the applicable period.

In accordance with the provisions set forth in item 5.7 of Chapter 7 of the Procedures, any differences arising out of the amounts payable by the debtors, considering that a portion thereof (distribution companies) does so under a seasonal price system, and the amounts to be collected by the creditors as a result of the transactions carried out at spot prices, shall be absorbed by a price stabilization system based on the existence of a temporary deposit fund named “Stabilization Fund”.

The amounts for such months in which the results derived from the application of the seasonal price system have a positive balance as compared to the Spot Market prices shall be deposited in the Stabilization Fund. In turn, during such months in which the results have a negative balance, this fund shall provide the financial resources necessary to complete the amount payable to the sellers.

The availability of resources in the Stabilization Fund is calculated when the market price is established for the relevant quarter, in order to avoid surplus or shortages in this Fund, and that the availability of resources in the Stabilization Fund allows for the avoidance of seasonal increases. On the contrary, the smaller the funds existing in the Stabilization Fund, the lower the chances of sanctioning low prices within the resulting values for the different foreseeable events, and vice versa.

As a consequence of the measures adopted after the enactment of Law 25,561, the electricity generators could not pass onto end-users the increased prices of costs, particularly the increase of natural gas. Therefore, the amounts paid by end-users did not cover the electricity generation costs.

As a result of the deficit in funds required to pay WEM agents, the former Secretariat of Electric Energy issued Resolution No. 406/03. Section 4 of such resolution provides that if there are insufficient resources, the order of priority to settle debts owed to WEM creditors should be the following: (a) the amounts due as receivables payable to the unified fund created by Section 37 of Law No. 24,065; (b) the monthly income to be allocated to the WEM funds and accounts; (c) the amount necessary to pay for the receivables of WEM agents once the remuneration items set forth in subsections (d), (e) and (f) have been paid; (d) the items related to the payment of remuneration for the capacity and services rendered to the WEM; (e) the amounts pertaining to: (i) the energy produced and delivered in the hourly spot market valued at its operating cost based on the variable production costs declared and approved for thermal generation plus all the relevant transmission charges, (ii) the energy produced and delivered at the hourly spot market by hydroelectric plants, valued at the representative average operation and maintenance cost of a hydroelectric power plant established in Annex 26 to the Procedures plus the total amount of the relevant transmission charges (Ps. 2 per MW per hour), (iii) the remuneration payable to electric power transmission companies and (iv) the additional providers of technical transmission services that are not distributors and have receivables in the WEM in connection with the transactions of large users in the market; and (f) the commitments assumed in relation to Annexes II, III, IV of Resolution SE No. 01/03. To overcome these problems and take into account the forecasts of the future increase in demand, the Argentine executive branch has launched different programs and policies promoting the availability of new generation capacity. For example, the *Energía Plus* and *Energía Distribuida* programs were implemented to encourage private sector investments in new generation facilities, allowing owners to sell the energy produced at prices sufficient to cover the cost of the projects plus a reasonable profit. The purpose of these measures is not only to overcome the current energy shortage situation, but also to add installed capacity to satisfy the steady growth in demand that is expected in the short and medium term.

In response to the LVFVDs not paid to the power generators, the former Secretariat of Electric Energy issued Resolution No. 712/2004 and created the “*Fondo para Inversiones que Permitan Incrementar la Oferta de Energía Eléctrica en el Mercado Eléctrico Mayorista*” (hereinafter, the “FONINVEMEM”). The FONINVEMEM is administered by CAMMESA and its purpose is to raise funds to be invested in energy generation projects. To contribute capital to the FONINVEMEM, the former Secretariat of Electric Energy invited all WEM participants

holding LVFVDs that originated from January 2001 to December 2006 to contribute such credits to the FONINVEMEM.

The FONINVEMEM reimburses the private sector contributors the amount of their contributed receivables in 120 equal, consecutive monthly installments starting from the commercial launch date of the plants, converted into U.S. dollars at the rate effective as of the date of the applicable agreement, with interest at the interest rate specified in the applicable agreement for each project.

In accordance with the agreements for each project, after the first 10 years of operation, ownership of the Combined Cycle plants will be transferred from the respective trusts to the operating companies, and the operating companies will begin to receive the revenue from the sale of energy generated by the plants. At such time, the ownership interests of the private sector generators in each operating company will be restructured based on the contributions made by each party.

In the initial stages of the FONINVEMEM, generators were entitled to participate in the construction of two new 800 MV Combined Cycle thermal generation plants (*Central Termoeléctrica Manuel Belgrano and Central Termoeléctrica Timbúes*).

Subsequently, in 2010, an agreement with WEM generators was entered into to promote new electric power generation to satisfy the increase in the energy and capacity demand and also to facilitate the settlement of the generators' receivables from CAMMESA for electric power sales. Within the framework of such agreement, Central Puerto S.A. and the Endesa and Duke groups submitted a project for the construction of a Combined Cycle thermal generation plant named Central Vuelta de Obligado, in Timbúes, Province of Santa Fe, Argentina, and, in turn, The AES Group submitted a project for the construction of Central Guillermo Brown, located in Bahía Blanca, Province of Buenos Aires.

#### ***(v) Social tariff***

Through Resolution No. 1091/2017, as amended, the former Secretariat of Electric Energy regulated the mechanism of application of the social tariff and the saving incentive scheme. Through the Tax Sharing Agreement entered into on September 13, 2018, subsequently ratified by Law No. 27.469, the Provinces agreed that as from January 1, 2019 each jurisdiction shall define the differential electric tariff based on the residential users' socioeconomic conditions.

Consequently, through Resolution No. 566/18, the SGE abrogated Resolution SEE 1,091/ 2017, effective as of January 1, 2019.

#### **Renewable Energy Program: Laws No. 26,190 and No. 27,191**

In recent years, Argentina has prioritized the generation of electric power from renewable sources. In such regard, it has not only issued regulations intended to regulate and incorporate this type of energy into the WEM, but it has also promoted this type of energy by granting incentives in the form of tax benefits and preferential or subsidized tariffs.

To promote renewable energy, Law No. 26,190 was enacted in December 2006 and approved the Promotional Regime for the Use of Sources of Renewable Energy destined to Electric Production (the "Promotional Regime"). The renewable energy sources provided for in this system include wind, solar, geothermal, tidal, hydraulic (hydroelectric power plants up to 30 MW), biomass, landfill gas, sewage-treatment plant gas and biogas (except for the uses provided for in Law No. 26,093 on biofuels). The purpose of Law No. 26,190 is to increase the proportion of energy provided by renewable energy sources to 8% of the national electric power consumption within 10 years from its effective date. Law No. 26,190 also established a system of investments for the construction of new works intended to generate electric power from renewable energy sources, which will remain in force for a term of ten years. The system set forth by Law No. 26,190 has been excluded from the general remuneration scheme regulated by Resolution SE No. 95/13 (as described below).



The beneficiaries of this system are individuals and legal entities that hold investments and concessions for new renewable energy generation works in Argentina that have been approved by the Enforcement Authority. The energy must be intended for the WEM and the project must be related to the rendering of public services.

On September 23, 2015, Law No. 26,190 was amended by Law No. 27,191. The amendments seek to establish a legal framework to increase investments in renewable energies and foster the diversification of the electric power generation mix, increasing the participation of renewable sources. To such end, the law, among other things:

- sets renewable energies consumption targets for all of Argentina's electric power consumers, as minimum percentages of renewable energies electric power that they are required to consume as of December 31 of the following years: 8% for 2017, 12% for 2019, 16% for 2021, 18% for 2023, and 20% for 2025;
- amends and expands the tax benefits for eligible projects;
- establishes the FODER as a trust fund for which the Argentine government serves as the trustor, BICE serves as the trustee and the owners of the approved investment projects are the beneficiaries. The trust fund must allocate the trust assets to extend credit, make capital contributions and acquire all such other financial instruments as required for the execution and financing of eligible projects involving electric power generation from renewable sources; and
- establishes obligations for large users and large demand: clients of electric power distribution providers or distribution agents with capacity demand equal to or higher than 300 KW must meet gradual goals through self-generation or otherwise purchase such electric power from generators (directly or through electric power distributors or brokers or from the wholesale market operator CAMMESA), at a price which may not exceed an average of US\$113/MWh until March 30, 2018, and thereafter at a price determined by the Enforcement Authority; the option to satisfy the consumption targets through CAMMESA and not individually shall be available until December 31, 2017.

Pursuant to Decree No. 531/16 (modified by Decree No. 471/2017 and 962/2017), the Argentine government set forth general guidelines and principles for the development of energy projects, by delegating the procedures for compliance with energy goals, bids or auctions for the implementation of the FODER to the SGE. The most important aspects of these regulations are the following:

***(i) Scope of the Promotional Regime***

The system is applicable to projects for the construction of new facilities or for expanding or upgrading existing ones, the acquisition of new or second-hand equipment, to the extent new assets, works and other services are used for the project and are directly connected to the project. Access to the system is allowed for projects for which, after having been selected under Resolutions No. 220/2007, 712/2009 and 108/2011 set forth by the former Secretariat of Electric Energy, construction has not yet begun and that have been selected by the Enforcement Authority and the executed agreement is terminated. Projects for which construction has begun may also be eligible to the extent amendments to the executed contracts are allowed, as required by the enforcement authority. The Enforcement Authority must establish the merit order for projects that have been approved and determine the granting of the promotional benefits for each project.

The goals established by the law are audited annually. Users are allowed a 10% margin of error per year for achieving the goals related to energy consumption from renewable sources established by the law.

The Enforcement Authority must establish the terms and conditions under which it will allocate a portion of the funds of FODER's financing account to finance the development projects of the value chain of local production of power generating equipment, using renewable energy sources, parts or components.

***(ii) Tax Benefits Under Law No. 26,190***

The former regime includes the following tax benefits:

- Early refund of the VAT on the project's new depreciable assets: the VAT as invoiced to the beneficiaries on the purchase, production, manufacture or final import of capital goods or the execution of infrastructure works shall be credited against other taxes by the AFIP as soon as at least three fiscal periods have elapsed, as counted from the fiscal period in which the investments were made, or it shall be recoverable in the term provided upon approving the project, under conditions and with the guarantees set forth in that respect.
- Accelerated asset depreciation for purposes of income tax: the beneficiaries may apply depreciations on the investments associated with the projects subsequent to their approval and under the terms set forth therein. These depreciations are subject to a differential treatment depending on their timing, within the first, second or third 12-month period after project approval. This alternative is subject to the condition that the assets are to remain as property of the project holder for at least three years.
- Non-calculation of the minimum presumed income tax provided by Law No. 25,063 on the assets allocated to the projects initiated under the system created by the renewable energy law: this benefit applies to the three fiscal years preceding the completion of the relevant project. The assets must be connected to the relevant project and must be acquired by the company after the approval of the project.

The regime also provides for certain additional compensation. In that regard, the projects will be entitled to an additional compensation equivalent to US\$0.015 per KW/h payable to the generators that produce electric power from renewable sources, except in the case of solar-based electric power, for which generators will collect US\$0.9 per KW/h. Such additional compensation will be paid according to: (1) fuel substitution, (2) the involvement of Argentine industries and job creation opportunities and (3) the amount of time it takes to launch the project.

***(iii) Tax benefits under Law No. 27,191***

The Promotional Regime includes the following tax benefits:

- Early refund of VAT and accelerated depreciation of assets for income tax purposes, with beneficiaries being able to apply for both benefits simultaneously, subject to reduced benefits based on the actual commencement date of the project's execution.
- Extension to 10 years of the tax loss carryforward term. Tax loss carryforwards arising from the promoted activity may only be set off against net profit arising from the same activity.
- Exclusion of assets connected to the activity subject to the Promotional Regime from the taxable base related to the minimum presumed income tax until the eighth fiscal year following the project's commencement (including the first year). Excluded assets are those connected to the project subject to the Promotional Regime and included in the owner's net worth after the approval of such project.
- A 10% exemption on tax on the dividends distributed by the companies that own the projects subject to the Promotional Regime, which are reinvested in new infrastructure projects within Argentina.
- Tax certificate applicable to the payment of income tax, VAT, minimum presumed income tax and excise taxes for an amount equal to 20% of the value of components of electromechanical facilities made in Argentina, provided that at least 60% of the components (excluding civil works) are made in Argentina. Where there is insufficient or a lack of production in Argentina, the percentage is reduced to 30%. The assignment of the tax certificate is conditioned upon the fact that the taxpayer cannot have liquidated debts due and payable to the AFIP.

Other benefits, including the possibility of shifting increased costs arising from tax increases to the price of the renewable energy sold; exemption from import duties and the statistical rate for the import of new capital assets, special equipment and related parts and components that are necessary for, among other things, the execution of the project; and the exemption from special taxes, fees and royalties of any jurisdiction imposed on the access to and use of renewable sources of energy within participating jurisdictions until December 31, 2025, excluding potential fees payable on the use of the state-owned land where the projects are based.

Those who wish to participate in the Promotional Regime must waive the benefits afforded by previous systems under Laws No. 25,019 and 26,360, and the projects that benefitted from such systems may only have access to the Promotional Regime if the works committed under the contracts executed thereunder have not commenced as of the date of the application.

***(iv) Use of renewable sources to generate electric power: General Resolution AFIP No. 4101-E/2017***

The resolution sets forth the requirements to be satisfied by the subjects included in the Promotional Regime concerning the submission, request and effective crediting or early refund of the tax invoiced by them.

VAT registered taxpayers that invest in electric power generation projects using renewable sources of energy in all the Argentine territory may request the crediting or early refund by AFIP of the VAT levied on the purchase, manufacturing, preparation or final import of new capital assets or on the execution of infrastructure, electromechanical and assembly works in accordance with the Promotional Regime for the use of renewable sources to generate electric power (Law No. 26,190).

To have access to the crediting of the invoiced tax against other taxes levied by AFIP, taxpayers should have the Certificate of Inclusion set forth in Regulatory Decree No. 531/2016 and should fall under the scope of the provisions set forth in section 3 of Resolution No. 202/2016 - E of the former MEyM.

Furthermore, the rule establishes the fiscal requirements necessary to apply for such crediting, including having a CUIT (Tax Identification) number, being registered for tax purposes, and having an updated code of business, among others. Requesting parties may also use a service available in the AFIP webpage “Law 26,190 –Promotional Regime for the use of renewable sources of energy”. One request may be filed per each VAT fiscal year as from the 21<sup>st</sup> day of the relevant month of maturity.

The system also allows for the cancellation of tax liabilities, provided that the subject is both the passive holder of the liability and the active holder of the receivable. In this case, any requests previously submitted should be waived.

***(v) The Renewable Energy Term Market: Resolution No. 281-E/17 of the former MEyM***

On August 22, 2017, the former MEyM published Resolution No. 281-E/17 approving the “Renewable Energy Term Market Regime”

The purpose of the resolution is to encourage a dynamic participation in the term market and to foster the increase of private agreements between the WEM agents and participants. Its aim is to provide a feasible alternative for the purchase of energy to tenders by CAMMESA.

This resolution enables large users to comply with their renewable energy consumption quotas through either (i) the joint purchase system (*i.e.*, through CAMMESA), (ii) the execution of private PPAs or (iii) the development of a self-generation project or a co-generation project.

As a general principle, PPAs executed in the term market (outside the joint purchase system) may be freely negotiated between the parties with respect to term, priorities, prices and other contractual conditions.

Section 7 of Resolution No. 281 provides that, in the case of curtailment, the following power generation plants will have (i) equal dispatch priority between them; and (ii) first dispatch priority over renewable generation projects operating in the term market without an assigned dispatch priority:

- run-of-the-river hydropower plants and renewable power plants having commenced commercial operation prior to January 1, 2017;
- power plants supplying energy pursuant to PPAs executed in connection with Resolutions No. 712/2009 or No. 108/2011 having commenced commercial operation prior to January 1, 2017;
- renewable power plants supplying energy pursuant to PPAs executed with CAMMESA through the RenovAr Program;
- renewable power plants supplying energy pursuant to Resolution MEyM No. 202/2016; and
- renewable power plants operating in the term market (*e.g.*, private PPAs) which have obtained dispatch priority in accordance with the regime established pursuant to Resolution No. 281.

A request for dispatch priority with CAMMESA only needs to be filed for the expansion of the abovementioned projects. Upon such request, CAMMESA will then evaluate submissions on a quarterly basis and prepare a list of granted dispatch priorities in interconnection points or transmission corridors with restrictions to the transmission capacity.

Furthermore, the Resolution created the RENPER for the registration of all the power generation, co-generation and self-generation projects from renewable sources.

The Dispatch Organization would publish in its website the available transmission capacity for the addition of power generated by generation, co-generation or self-generation plants from renewable sources, stating the information regarding the registered and pending requests; such information shall be updated on a monthly basis.

This resolution also set forth a priority order in the case of congestion of the transmission system and while the transmission restriction is operative, for the dispatch of power generated by generation plants from renewable sources. The priority dispatch was also regulated for future transmission capacity.

*Resolution No. 70-SGE/2018:*

In November 2018, Resolution No. 70-SGE/2018 allowed the purchase of fuel by generators on an optional basis. The call to declare the CVP for the enabled groups is voluntary and renewable on a fortnightly basis. Generation costs with own fuel shall be determined in accordance with the production variable cost recognition mechanism used by CAMMESA. Furthermore, CAMMESA will remain in charge of the commercial management and fuel dispatch for those agents that do not exercise this option.

***(vi) Registration with RENPER: Provision No. 1-E/18 and Resolution No. 292/18 of the former MEyM***

This resolution sets forth the procedures for the enrollment with the registry created by section 9 of Resolution No. 281-E2017 of the former MEyM, and establishes the mechanism for granting the certificate of inclusion in relation with the tax benefits set forth by the regime. The resolution also determines the investment reference value and the maximum amount of tax benefits, as well as the tie-breaking mechanism for the allocation of priority dispatch in the event of insufficient transmission or transformation capacity, and establishes the applicable technical requirements. The selected tie-breaking mechanism considers the tax benefits, and it grants priority to the project that has declared the lowest amount of tax benefits per megawatt.

Likewise, the resolution foresaw the possibility to allow the owners of generation projects to assume responsibility for the full cost of any expansion works for transmission and transformation capacity required for the connection of the new plants, and to request dispatch priority for such expansions.

Enrollment with the registry must be made within 15 business days as from the filing of the request, which term shall be extended only in the event that the aggregate projects submitted exceed the estimated time for adopting a decision thereon.

The surplus of self-generators may be sold in accordance with the mechanism set forth in Resolution No. 281-E2017.

Resolution ME No. 292/18 governs the general procedure to change the project location, and provides that the place where the power generation projects with renewable sources committed in the Purchase Agreements entered or to be entered into by their owners and CAMMESA under RenovAr program rounds 1, 1.5 and 2 will be located can be changed provided that certain requirements are satisfied and that the relevant request is filed with CAMMESA.

***(vii) INTI Registry of Suppliers of Renewable Energies – ReProER: Resolution INTI No. 59/18***

Resolution No. 59/18 of the Instituto Nacional de Tecnología Industrial (National Institute for Industrial Technology, or “INTI”), created the Registry of Suppliers of Renewable Energies providing that suppliers of electromechanical goods of companies that benefit from investment projects under Law No. 26,190, as amended and regulated, must register with the registry created by this regulation to verify the origin of the electromechanical goods they produce.

***(viii) RenovAr (Round 1, Round 1.5 and Round 2): Bidding Process for Renewable Energy Generation Projects***

After carrying out a public consultation period to submit comments and suggestions to the preliminary version of the bidding terms and PPAs and due to the proximity of the period for submitting bids to the “Round 1” from the RenovAr Program, the Argentine President issued Decree No. 882/16, published on July 22, 2016 in the Official Gazette on the grounds of “necessity or urgency,” which decree has modified and established different precisions regarding the legal framework for the Promotional Regime.

Below are the main measures introduced by the Decree No. 882/16:

- Fiscal Quota: For the year ended December 31, 2016, a budget of US\$1,700,000,000 was approved in order to be allocated to the promotional benefits under the Promotional Regime. In case the specified budget is not allocated in full in 2016, it will be automatically transferred to the following year.
- PPAs term: In order to recover the investment and obtain a reasonable return, the PPAs will have a maximum term of 30 years.
- Put and Call Options: The PPAs may grant rights to: (a) the Argentine government to purchase the power generation or their assets upon material breaches of the contract that constitute grounds for termination; the purchase price will be lower than the unamortized investment at the time the option is exercised; and (b) the owner of the project to sell the power generation or their assets upon the occurrence of any of the “grounds for put option” for a price, which in no case may exceed the unamortized investment at the time the option is exercised.
- PPAs are subject to Argentine private law.
- Choice of Forum: In the event of any dispute concerning the interpretation or execution of the PPAs for disputes arising out of the contracts signed between the Argentine government or the FODER with the beneficiaries of the Promotional Regime, alternative dispute resolution methods from Argentina or abroad can be included in the PPAs.
- FODER: As a result of the Decree No. 13/2015 in which the former MEyM was established, the Decree No. 882/16 replaced paragraphs 2, 3, 7, 8 and 9 of Section 7 of Law 27,191 and proceeded to modify the Argentine government’s role in the FODER, establishing the former MEyM as trustor and trustee of the

FODER. It also granted power to the former MEyM (or his designee or replacement) to approve the trust agreement of the FODER and sign the trust agreement with the trustee.

- Guarantee of payment for put option: The decree empowers the Ministry of Treasury and Public Finance to issue and deliver treasury bills to the FODER (up to a maximum nominal value of US\$3,000,000,000 or its equivalent in other currencies) for and on behalf of the former MEyM and to guarantee the payment in the event that the owner exercises the put option and sells the generation plant.

For the year ended December 31, 2017 a fiscal quota of US\$1,800,000,000 was approved to be assigned to the benefits promotional (Law No. 27,341).

For the year ended December 31, 2018 a fiscal quota of US\$1,421,250,000 was approved to be assigned to the benefits promotional (Law No. 27,431).

For the year ended December 31, 2019 a fiscal quota of US\$500,000,000 was approved to be assigned to the benefits promotional (Law No. 27,467).

Law No. 27,431 approved the 2018 budget and authorized the Ministry of Finance to issue and deliver treasury bills to the FODER (up to a maximum nominal value of US\$2,422,500,000 or its equivalent in other currencies) for and on behalf of the former MEyM, against the issuance of certificates for amounts equal to the bills assigned in favor of the former MEyM, to guarantee the payment of the power generation plant sale price, acquired in accordance with the provisions set forth in sections 3 and 4 of the decree issued under the Ministers General Agreement 882 dated July 21, 2016.

Law No. 27,467 approved the 2019 budget and authorized the Ministry of Finance to issue and deliver treasury bills to the FODER (up to a maximum nominal value of US\$120,000,000 or its equivalent in other currencies) for and on behalf of the SGE, against the issuance of certificates for amounts equal to the bills assigned in favor of the former MEyM, to guarantee the payment of the power generation plant sale price, acquired in accordance with the provisions set forth in sections 3 and 4 of Decree No. 882/2016.

Resolution No. 136/2016, issued by the former MEyM and published in the Official Gazette on July 26, 2016, launched the public auction process for submitting bids for Round 1 of the RenovAr Program. Resolution No. 136/2016 also approved both the bidding terms and conditions of the above-mentioned auction and the PPAs.

According to the terms and conditions of such bid, the relevant PPAs shall include the following features and provisions:

- Purpose: The purpose of the agreement must be to supply the amount of electric power associated with the new equipment for electric power generation from renewable sources to the WEM beginning on the date on which the power station is permitted to operate in the WEM until the termination of the contractual term.
- Seller: The generation, co-generation or self-generation agent of the WEM whose bid is accepted pursuant to the provisions of this resolution and supplementary regulations set forth by the former Secretariat of Electric Energy.
- Buyer: CAMMESA, on behalf of the distribution agents and large users of the WEM (until its assignment among distribution agents or large users of the WEM), in order to meet the goals of renewable energy source contribution set since December 31, 2017 for the demand of electric power in the WEM.
- Term: Up to 20 years from the date on which operations commence.
- Type and technology of the energy to be supplied.
- Electricity committed to be delivered per year.

- Generation capacity of each unit and total installed capacity committed.
- Remuneration to be received by the seller and paid by the buyer for the electric power to be supplied, determined on the basis of the bid price in U.S. dollars per megawatt/hour (US\$/MWh).
- The terms and conditions of the seller’s contractual performance guarantee.
- The point of delivery of the electric power purchased shall be the connection node to the SADI.
- The remedies for contractual breach.
- The enforcement of the guarantee for payment through FODER’s escrow account.
- Contracts for the purchase of electric power shall have first priority in payment and rank equally with payments to the WEM.

On September 5, 2016, after concluding the period for submitting bids to the first round of the RenovAr Program, the former MEyM, Juan José Aranguren, and the Undersecretary of Renewable Energies, Sebastián Kind, pursuant to Resolution No. E 205/16 signed by the Minister of Energy and Mining, announced that 123 bids were submitted, requesting 6,366 MW (six times more than 1,000 MW originally tendered).

On October 7, 2016, the former MEyM finalized the bidding process for the installation of new units of renewable energy, through Resolution No. 213/2016 the Ministry awarded 1108.65 MW of power at an average price of US\$59.58, which includes one biomass project, 12 wind energy projects and four different solar energy projects. The Company was the successful bidder for a 100 MW wind energy project at a price of US\$61.50.

Through Resolution No. 252/2016, the former MEyM instructed CAMMESA to call interested parties to bid under the Renewable Energy Program “RenovAr Round 1.5” with the projects presented and not awarded in Round 1 of the Renewable Energy Program, for the purpose of contracting power generation from renewable sources to the WEM.

This resolution established that the bidders could be integrated by the same individuals or legal entities of the bidders presented in Round 1 or could vary their integration, totally or partially.

Additionally, pursuant to Resolution No. 275/17, the former MEyM called for the submission of bids (the “National and International Open Call for Tenders”) under the Renewable Energy “RenovAr Program (Round 2)”, for contracting power generation from renewable sources to the WEM, to enter into Term Market Agreements known as Power Purchase Agreements, with CAMMESA, acting on behalf of distribution companies and large users of the WEM, until their vesting on the distribution companies and large users of the WEM. Furthermore, the Resolution approved the Bidding Terms and Conditions and its Exhibits, and directed CAMMESA conduct the Open Call for Tenders.

The aggregate Requested Power to be awarded under such call was 1,200 MW, broken down by technology and region in accordance with the Bidding Terms and Conditions.

Under the call, bids were received in a closed envelope (Envelope “A” and “B”) and the envelopes “A” of the 228 offers submitted were opened, for a total capacity offered of 9,401.50 MW.

Following the assessment of the envelopes “A”, the Ministry issued Resolution No. 23/2017 which determined the qualification of the offers submitted, selecting those that had passed the formal, technical and legal evaluation and were thus able to access to the evaluation of the offers included in the envelopes “B”.

Thereafter, the envelopes “B” containing the qualified offers were opened. CAMMESA prepared a non-binding report including a list of offers with the distribution broken down by technology, and recommended the award

to the pre-selected offerors. The former SEE issued a technical report confirming the pre-awards recommended by CAMMESA.

Therefore, pursuant to Resolution No. 473/2017, the former MEyM determined the offers awarded under the National and International Open Call for Tenders in connection with the RenovAr 2.0 among a total of 228 projects with an aggregate installed capacity of 9,401.50 MW.

Additionally, the aforementioned resolution invited bidders of qualified bids for biomass, biogas, wind and solar projects, which were not awarded, to celebrate PPAs and the respective adhesion agreements to the FODER under the terms of Articles 6 and 7 of the Resolution No. 473/17, to cover a quota of 50% of the power capacity required per technology in the terms and conditions of RenovAr 2.0.

In accordance with section 6 of Resolution No. 473/17, the additional power requested by technology is as follows: a) wind technology: 275 MW; b) photovoltaic solar technology: 225 MW; and c) biomass and biogas technologies - together: 67.50 MW.

Through Resolution No. 488/2017, the former MEyM awarded the PPAs in accordance with Resolution MEyM No. 275/2017 and Resolution MEyM No. 473/2017.

Through Resolution No. 100/2018, the SGE called interested parties to bid on the National and International Open Call for Tenders for contracting power generation from renewable sources to the WEM –“RenovAr Program – MiniRen/Round 3”-, to enter into power purchase agreements from renewable sources, with CAMMESA, acting on behalf of Distribution Companies of the WEM, in accordance with the applicable bidding terms and conditions. The resolution also established that, in the offer, interested parties may request the tax benefits provided by Law No. 27,191 (*Regime for the promotion of renewable energies*) and released them from the obligation to provide any guarantees, in addition to the bid bond, as concerns the request for tax benefits. Likewise, the resolution set forth quotas of maximum amounts for the granting of tax benefits and the reference values for investments for each technology, to calculate the necessary expenditures to reach the effective execution principle of each project, in accordance with the provisions set forth in Law No. 27,191.

Through Resolution No. 100/2018 of the SGE, it was also established that generation plants to be built as a result of the award shall not have dispatch priority over other generation, self-generation or renewable cogeneration plants that operate in the WEM in case of SADI congestion, and that they shall be excluded from the priority provided by Resolution No. 281/2017 of the former MEyM. With respect to the payment priority of the renewable electric power supply agreements to be entered into, it was decided that they will be first in the order of priority.

Through Resolution No. 90/2019 (Published in the Official Gazette on March 12, 2019), the SGE introduced amendments to the call made by Resolution SGE No. 100/2018, in line with the contractual structure of the previous rounds of RenovAr Program, but also considering the specific characteristics of MiniRen/Round 3, specifically concerning the scale of the projects and the voltage level to which they will be connected. For this reason, it was established that CAMMESA shall enter into the PPAs as buyer, on behalf of the Distributors and large users of the MEM - until their vesting in the Distributor Agents and/or large users of the MEM - as in the previous rounds of the RenovAr Program, instead of on behalf of the WEM Distributor Agents exclusively. Likewise, the commercial commitments assumed by the Distributor Agent were eliminated, in accordance with the initial design of the call, establishing that the economic costs of the contracts to be entered into shall be borne by the aggregate demand, in the same terms as those established for the previous rounds of the RenovAr Program. The call for bids was addressed to those interested in bidding in the Open Call for Tenders for contracting power generation from renewable sources to the WEM –“RenovAr Program – MiniRen/Round 3”-, to enter into power purchase agreements from renewable sources, with CAMMESA, acting on behalf of Distribution Companies and large users of the WEM –until their vesting in the Distribution Companies and/or large users of the WEM- in accordance with the applicable bidding terms and conditions amended to such effect. As a result of this amending regulation, a new full schedule was established for the call.



## **Import and Export Transactions**

Pursuant to Decree No. 974/97, import and export transactions are conducted through the IITS, a public service subject to the concession granted by the former Secretariat of Electric Energy. Under such system, through Resolution No. 348/99, the former Secretariat of Electric Energy granted Interandes S.A. a concession for the IITS through the Güemes Transmission System, which connects the Central de Salta Thermal Generation plant located in Güemes, Salta, with the Sico Border Crossing, on the border with the Republic of Chile.

All import and export transactions conducted through the term market require the prior authorization of the Undersecretariat of Electric Energy (Resolution No. 98/18 of the former MEyM, which modified Resolution No. 64/18 of the former MEyM that refers to Resolution No. 25/2016 of the former MEyM) and CAMMESA.

## **Transmission and Distribution**

Pursuant to Law No. 24,065, transmission and distribution activities are regulated as public services due to the fact that they are natural monopolies. The Argentine government has granted concessions to private entities conducting these activities, subject to certain conditions, such as service quality standards and setting the tariffs they are entitled to collect for their services.

Electricity transmission is comprised of (i) a high-voltage transmission system (operated by the company TRANSENER S.A., which is currently co-controlled by Grupo Pampa Energía and IEASA), which connects the main electric power production and consumption areas allowing the transmission of electric power between different Argentine regions and (ii) several regional trunk systems, which transmit electric power within a particular region and connect the generators, distributors and large users that operate in such region.

The companies that act as transmission companies are as follows: 1) TRANSBA S.A. (Buenos Aires); 2) TRANSNOA S.A. (Northwest); 3) TRANSPA S.A. (Patagonia); 4) TRANSNEA S.A. (Northeast); 5) DISTROCUYO S.A. (Cuyo); 6) TRANSCOMAHUE S.A. (Comahue) and 7) Ente Provincial de Energía del Neuquén (“EPEN”).

There are other forms under which the electricity transmission activity may be conducted (as an independent transmission company, or an “Independent Transmission Company”), but since they are subject to different rules they are not included in the category of transmission company. The figure of the Independent Transmission Company is distinguished from the transmission due to the lack of the enabling title set forth by Law No. 24,065 to provide such public service activity, which is the concession of the public transmission service. Independent Transmission Companies are under the supervision of a transmission company under a “Technical License”, and their facilities are integrated into the respective transport system; the remuneration system combines the building, amortization and operation stages.

Some of the companies that act as an Independent Transmission Company, both in extra high voltage as per trunk distribution, are as follows: 1) Líneas de Transmisión del Litoral S.A. (LITSA); 2) YACYLEC S.A.; 3) E.D.E.S.A. ; 4) D.P.E.C. ; 5) E.R.S.A. ; 6) S.P.S.E. ; 7) ENECOR S.A.

Under the Public-Private Partnership Agreements –Law No. 27.328- the SGE issued Resolution No. 81/2019 (published in the Official Gazette on March 8, 2019) called for a national and international bidding to build the “500 kV-Extra High Voltage Line Río Diamante T.S. – Charlone New T.S., Transformation Stations and supplementary works in 132 kV”, which includes the 500 kV electric interconnection between Río Diamante T.S. – Charlone T.S. and the supplementary works, and the subsequent operation and maintenance services, for the Public-Private Partnership Project denominated “*Transmission Lines – Stage I: 500 kV-Extra High Voltage Line Río Diamante T.S. – Charlone New T.S., Transformation Stations and supplementary works in 132 kV*”. The Resolution also approved the Bidding Terms and Conditions and its exhibits.

Electricity distribution is regulated only at the federal level for the City of Buenos Aires and the districts in the metropolitan areas of Greater Buenos Aires. EDENOR S.A. operates in the northern area of both the City of Buenos Aires and Greater Buenos Aires, and EDESUR S.A. operates in the southern area of both the City of Buenos

Aires and Greater Buenos Aires. In the rest of the country, the electric power distribution service is regulated at the provincial level and subject to concession granted by provincial authorities.

On February 28, 2019, the Agreement for the Transfer of Jurisdiction of the Public Electricity Distribution Service to the Province of Buenos Aires and to the City of Buenos Aires was entered into, by means of which EDENOR S.A. and EDESUR S.A. were transferred to the Province of Buenos Aires and the City of Buenos Aires. Although the agreement was not published in the Official Gazette, it was revealed that it contains eight operative paragraphs: the first would grant police power over the public service provided by the concessionaires to the jurisdiction of the Province of Buenos Aires and the City of Buenos Aires. Furthermore, the agreement sets forth the creation of a two-party entity for control and regulation, to replace the ENRE, and until that happens, the Province of Buenos Aires, the City of Buenos Aires and the Argentine government shall continue to regulate the electric service to ensure the continuity of the control and regulation powers. Another relevant point agreed upon is that, effective January 1, 2019, the Province of Buenos Aires and the City of Buenos Aires shall use their own funds for the disbursements associated with the social tariff.

Transmission services are rendered by concessionaires that operate and use high and medium voltage transmission lines. Transmission services consist of the transformation and transmission of electric power from generators' delivery points to distributors' or large users' reception points. Law No. 24,065 provides that energy transmission companies must be independent from other WEM participants and prohibits them from purchasing or selling electric energy.

Distribution companies are in charge of supplying electric power to end-users who cannot contract with an independent electric power supply source due to their consumption levels, such as residential end-users.

The main characteristics of concession contracts for the transmission and distribution of electric power are: (a) service quality standards with penalties that are applied in case of breach; (b) a concession term of 95 years for the monopoly of the supply service in a supply area or network, divided into "management periods," with an initial term of 15 years and subsequent terms of 10 years (at the end of each management period, the Argentine government must call for bids to sell the majority stake of the corresponding transmission or distribution company); and (c) tariffs fixed based on economic criteria with a limit price or "price cap" system and predefined processes regarding their calculation and adjustment.

The tariffs charged by electric power transmission companies include: (a) a connection charge, (b) a transmission capacity charge and (c) a charge for actually transmitted energy. In addition, transmission companies may receive income derived from the expansion of the system. Transmission tariffs are passed on to final users through the distributors.

The amounts that distribution companies charge to end-users include: (a) the price for the purchase of energy in the WEM (the seasonal price as described above), (b) transmission costs, (c) the value-added for distribution ("VAD"), which compensates the distributor, and (d) taxes. The VAD is the marginal cost of providing services, including the network development and investment costs, operation maintenance and commercialization costs, as well as depreciation and a reasonable return on the invested capital. The tariffs determined as set forth above must enable an efficient distributor to cover its operating costs, finance the renovation and improvement of its facilities, satisfy increasing demand, comply with established quality standards and obtain a reasonable return, while also enabling such distributor to comply with certain operating efficiency standards and operate in a manner consistent with the amounts it has invested and the national and international risks inherent in its operations.

In January 2002, the electric power sector was significantly affected by the Public Emergency Law No. 25,561 and the measures adopted as a consequence thereof. As a result of the law, electric power transmission and distribution tariffs were converted into pesos and frozen for more than six years. During this period, they were only subject to limited and small-scale increases.

The contract renegotiation process provided for by the Public Emergency Law for public contracts subject to federal jurisdiction, including the concessions granted for electric power transmission and distribution in the City of Buenos Aires and La Plata, progressed very slowly.

After more than five years of negotiations, electric power transmission and distribution companies reached an agreement with the Argentine government with the participation of the Renegotiation and Analysis of Public Services Contracts Unit (*Unidad de Renegociación y Análisis de Contratos de Servicios Públicos – UNIREN*), which was created within the scope of the Ministries of Economy and Federal Planning, Public Investment and Services. As a result of these negotiations, transmission tariffs were subject to the abovementioned limited and small-scale increases. In the distribution sector, the renegotiation agreements provided for limited increases in income and to a portion of the tariffs (namely, the VAD). Such increases were generally applied to commercial and industrial users, while a “*Revisión Tarifa Integral*” (Comprehensive Tariff Review) that would include residential users was postponed on several occasions. This delay in updating rates caused an imbalance in the payments that distributors made to CAMMESA and those charged by the generators to CAMMESA, which resulted in shortages in the stabilization fund and delays in payments to generators.

Decree No. 367/16 provided for a Comprehensive Tariff Review derived from the contractual renegotiation integral agreements in order to fix the new applicable tariff schedule.

In 2017, the ENRE approved the Comprehensive Tariff Review (“CTR”) for transmission companies. Prior to the approval of the CTR, the ENRE had: (i) approved the sanction regime applicable for quality objectives not met (Resolution No. 552/2016, rectified by Resolution No. 580/2016); (ii) approved the real return rate after taxes that transmission companies had to consider in order to determine their income; and (iii) ordered a Public Hearing for the purpose of evaluating the Tariff Proposal for CTR.

Through Resolutions No. 37/2018, 38/2018, 39/2018, 40/2018, 42/2018, 44/2018, 45/2018 and 46/2018, as amended by Resolutions No. 99/2018, 100/2018, 101/2018, 102/2018, 103/2018, 104/2018, 105/2018 and 106/2018, respectively, the ENRE approved the hourly rates with effect from February 1, 2018 applicable to TRANSENER S.A., TRANSBA S.A., TRANSNOA S.A., TRANSNEA S.A., TRANSPA S.A., DISTROCUYO S.A., EPEN, and TRANSCOMAHUE S.A.

Through Resolution No. 1085/2017 (published in the Official Gazette on November 30, 2017) the former Secretariat of Electric Energy approved the cost distribution methodology that represents the remuneration of the Public Service of Electricity Transport in Extra High Voltage and Trunk Distribution in the WEM. This regime of allocation of costs of the electric energy transmission service provided for the participation of WEM agents, both users and contributors, and established that the costs associated with the remuneration of transport companies are to be distributed according to the demand and/or energy contribution of each WEM agent, as the case may be (distributors, large users, self-generators and generators), directly and/or indirectly linked to the High Voltage Electricity Transmission System and/or the Transmission System of Electric Power by Trunk Distribution, discounting the costs allocated to the Generator Agents as operating and maintenance costs of the connection and transformation equipment. Therefore, Generator Agents shall pay a transportation charge that will be a value representative of the operating and maintenance costs of the connection and transformation equipment used for connection to the system, considering the voltage level and its characteristics. These values are regularly determined through an assessment of "standard costs" and communicated to the OED for its application. The amounts paid by Generator Agents shall be deducted from the values corresponding to each transmission company before the price determination process.

In 2017, the distributors’ CTR process was also carried out. Distributors filed their tariff proposal requesting the approval of the Own Cost of Distribution that they intended to apply during the next tariff period. The ENRE approved the return rate applicable to transmission companies (Resolution No. 493/2016 as amended by Resolution No. 494/2016).

The former Secretariat of Electric Energy instructed the ENRE to limit the increase in the Own Cost of Distribution resulting from the CTR that was to be applied as of February 1, 2017, to a maximum of 42% with respect to the Own Distribution Cost effective as of January 31, 2017 in two stages: the first one in November 2017 and the second one in February 2018; and set forth that the ENRE must pay EDENOR S.A. and EDESUR S.A. the difference in the Own Cost of Distribution caused by the gradual application of the tariff increase recognized in the CTR. The ENRE ordered a public hearing to be held to evaluate the proposals for the full tariff review filed by these licensees for such five-year period (Resolution No. 522/2016), which hearing was held on October 28, 2016.

Through Resolution No. 64/2017, as amended by Resolutions No. 80/2017 and 92/2017, the ENRE approved the values of the Own Cost of Distribution resulting from the CTR of EDESUR S.A. to be applied from the billing corresponding to the reading of power meters after 12:00 AM on February 1, 2017, and the values of the Own Cost of Distribution to be applied as from the billing corresponding to the reading of power meters after 12:00 AM on November 1, 2017 and February 1, 2018, respectively; and the new tariff scheme effective as of February 1, 2017 and March 1, 2017. Also, through Resolution No. 63/2017, as amended by Resolutions No. 82/2017 and 92/2017, the ENRE approved the values of the Own Cost of Distribution resulting from the CTR of EDENOR S.A. to be applied from the billing corresponding to the reading of power meters after 12:00 AM on February 1, 2017, and the values of the Own Cost of Distribution to be applied as from the billing corresponding to the reading of power meters after 12:00 AM on November 1, 2017 and February 1, 2018, respectively; and the new tariff scheme effective as of February 1, 2017 and March 1, 2017. Through Resolution No. 329/2017, the ENRE established the procedures for the calculation and perception of the difference in the Own Cost of Distribution resulting from the aforementioned deferral. Through Resolution No. 602/2017, as amended by Resolution No. 623/17, and through Resolution No. 603/2017, as amended by Resolution No. 624/17, the ENRE approved the values of the Own Cost of Distribution resulting from the CTR of EDESUR S.A and EDENOR S.A. to be applied from December 1, 2018. At present, the values of the Own Cost of Distribution for EDESUR S.A and EDENOR S.A. are determined through ENRE Resolutions No. 26/2019 and 27/2019.

Through Resolution No. 1091/2017, the former MEyM established the Reference Prices of the Power, the Stabilized Energy Prices and Stabilized Transportation Prices, effective as of February 1, 2018; a new mechanism for applying the social rate; and the new saving incentive scheme. Finally, through Resolutions No. 32/2018 and 33/2018 the ENRE approved the new tariff scheme effective as of February 1, 2018, adjusting the fixed costs and the Own Cost of Distribution of Distributors. Resolution No. 366/2018 of the SGE abrogated Resolution No. 1091/2017 and set forth the Reference Prices of the Power and the Stabilized Energy Prices effective as from February 1, 2019.

## **Large Users**

In the WEM, large users can operate independently contracting their supply for own consumption or in an integrated form to the Distributor.

The WEM classifies large users of energy into three categories: (i) GUMA, (ii) GUMEs, and (iii) GUPAs.

- GUMAs are users with a maximum capacity equal to or greater than 1 MW and a minimum annual energy consumption of 4,380 MWh. These users are required to contract at least 50.00% of their demand and purchase the rest from the Spot Market. Their transactions in the Spot Market are invoiced by CAMMESA.
- GUMEs are users with a maximum capacity ranging from 30 kW to 2,000 kW. They are not required to have any minimum annual demand. These users are required to contract all of their demand and do not operate in the Spot Market.
- GUPAs are users with a minimum capacity of 30 kW and a maximum of 100 kW. They are not required to have any minimum annual demand. These users are required to contract all of their demand and do not operate in the Spot Market.

The former Secretariat of Electric Energy issued Resolution No. 1281/06 which classified the SADI demand and established supply priorities. The resolution provided that the energy available in the Spot Market must be used primarily to serve the demands supplied by Distributors and/or Suppliers of the Public Services of Electric Power Distribution of the WEM, and then to serve demands of up to 300 kW for customers of the Distributors and/or Suppliers of the Public Services of Electric Power Distribution of the WEM that have not entered into term contracts. Large customers of WEM and large demands supplied by Suppliers of the Public Services of Electric Power Distribution and/or Distributors, in both cases with consumption higher than 300 KW, are only entitled to contract physical support for the remaining part not committed in the Term Market of their demand of energy and power registered in the “*Año Base*” (Base Year) (2005) determined in accordance with the methodology set forth in Exhibit II of this resolution, through thermal generation, with fuel availability, of the WEM agents existing as of the date of

publication of this resolution. The consumption of energy power in excess of the one recorded in the “*Año Base*” must be satisfied with energy from the *Energía Plus* service, consisting of the supply of additional energy generation from new generators and generators, co-generators or self-generators that are not agents of the WEM or who, as of the date of publication of the resolution, were not interconnected with the WEM. The price required to pay for excess demand, if not previously contracted for under the *Energía Plus* plan, was originally fixed to be equal to the marginal cost of operation.

Through Resolution No. 95/2013, the former Secretariat of Energy set forth that large users of the WEM had the obligation to acquire their electric power demand from CAMMESA, temporarily suspending the inclusion of new power purchase agreements in bulk entered into with the Generators affected by the provisions of such rule, until the adoption of the regulatory measures applicable to achieve such goals.

In 2016, the former SEE issued Resolution No. 21/16 calling interested parties to submit bids for new thermal generation capacity and associated energy production. The resolution provided that the agent whose bid was accepted would enter into a Wholesale Demand Agreement to sell the available electric power and associated energy in the WEM, to be entered into initially by CAMMESA and then assigned to the distributor agents and large users of the WEM. The guidelines of said agreement are set forth in Resolution No. 21. CAMMESA must certify in favor of the seller agent the proportional share that large users and distributors must pay in consideration for the electric power consumed, for purposes of its collection.

The Promotional Regime stipulated incentives for the increase of the proportion of energy provided by renewable energy sources in order to achieve 12% of the aggregate amount of consumption as of December 31, 2019, increasing such proportion to 20% as of December 31, 2025. By regulating the Promotional Regime for the Use of Renewable Sources of Energy allocated to the Electric Power Production Law No. 26,190, modified and expanded by Law No. 27,191, provides that large users of the WEM with capacity demand equal to or higher than 300 KW, must meet the abovementioned goals of covering annual consumption with electricity generated from renewable sources, and to such effects, may self-generate or purchase such electric power from other renewable sources under the *RenovAr* program (Article 9), which included the electricity demand of those users that do not qualify as large users. In that respect, large users must expressly state before CAMMESA the mechanism chosen to comply with Article 9 of Law No. 27,191. Otherwise, such large users will automatically be included in the mechanism of joint purchases of electric energy coming from renewable sources carried out by CAMMESA. Decree No. 531/16, which regulates Law No. 26,190 and Law No. 27,191, provides that the annual consumption from renewable sources goal may be satisfied in any of the following manners: (i) by means of individual purchase of electric power from sources of renewable energy; (ii) by means of self-generation or co-generation from renewable energy sources; or (iii) by means of the mechanism of joint purchase developed by CAMMESA or the entity that the Enforcement Authority may appoint. That is to say, through the purchase of electric power from renewable sources directly from CAMMESA or the entity appointed by the Enforcement Authority. In that respect, those subject to the provision of Article 9 of Law No. 27,191 that elect the individual purchase, or the self-generation or co-generation, must expressly state so to the Enforcement Authority in order to be excluded from the joint purchase mechanism. Otherwise, they shall be automatically included in the mechanism of joint purchases of electric energy from renewable sources carried out by CAMMESA.

In compliance with the purpose set forth in Laws No. 26,190 and 27,191, the former MEyM implemented the *RenovAr* Program, and up to date the following stages have been developed: (i) Round 1 –called by Resolutions MEyM No. 71/16 and No. 136/2016–; (ii) Round 1.5 –called by Resolution MEyM No. 252/2016–, (iii) Round 2 –called by Resolution MEyM No. 275/2017–; and (iv) Round 3 – called by Resolution SGE No. 100/2018, as amended by Resolution SGE No. 90/2019. Under the different Rounds developed under the Program, CAMMESA acted on behalf of Distributors and/or large users of WEM, thereby developing the joint purchase mechanism.

Through Resolution No. 281-E/2017, the former MEyM regulated the Renewable Energies Term Market by means of which large users included in section 9 of Law No. 27,191 may satisfy their electric power consumption needs by individual purchases, by electric power co-generation or self-generation from renewable sources, setting forth the appropriate legal framework for this new market.

## **Traders**

Law No. 24,065 and its Regulations -Decree No. 1398/1992- do not recognize the traders as WEM agents. Through Decree 186/1995, the Argentine government recognized the following as WEM participants (section 5): (i) companies that have obtained authorization from the former Secretariat of Energy Electricity to commercialize the electrical energy coming from international interconnections and binational ventures; (ii) companies that, without being WEM agents, trade energy power in bulk; and (iii) companies that, without being WEM agents, operate facilities used in Electric Linking Function, also called Technical Function of Electric Energy Transport.

Through Resolution No. 21/1997, the former Secretariat of Energy and Ports regulated the entry of participants to the WEM, and the commercialization regime of the WEM (currently Annexes 31 and 32 of the Procedures for the Programming of the Operation, the Dispatch of Loads and the Calculation of Prices) that -among others things- established that to act as a trader of the WEM is necessary not to be a recognized agent of the WEM.

The trader can undertake transactions in the WEM once it is qualified as WEM participant (article 1, Decree No. 186/1995).

The performance of the traders within the WEM is limited to the purchase and sale of electric power, on its own behalf or on behalf of third parties. The trader can intervene in the WEM commercial operations but not in physical operations.

A company expressly authorized as a WEM trader can carry out the following functions within the WEM: (i) electric power commercialization; (ii) demand marketing; (iii) import and export marketing; and (iv) commercialization of royalties.

## **Vertical and Horizontal Restrictions**

The WEM agents are subject to vertical restrictions, pursuant to Law No. 24,065 and Decree No. 1398/92, according to which:

- Neither a generation or distribution company nor a large user or any of its controlled companies or its controlling company, can be an owner or a majority shareholder of a transmission company or the controlling entity of a transmission company. Nevertheless, the executive branch may authorize a generation or distribution company or a large user to build, at its own cost and for its own need, a transport network for which it will establish the manner and form of operation;
- the holder of a distribution concession cannot be the owner of generation units; however, the shareholders of the electric power distributor may own generation units, either personally or through any other legal entity created with the purpose of owning or controlling generation units; and
- no transmission company may purchase or sell electric energy.

Section 33 of the Argentine Corporate Law states that “companies are considered as controlled by others when the holding company, either directly or through another company: (1) holds an interest, under any circumstance, that grants the necessary votes to control the corporate will in board meetings or ordinary shareholders’ meetings; or (2) exercises a dominant influence as a consequence of holding shares, quotas or equity interest or due to special linkage between the companies.” However, we cannot assure you that the electric power regulators will apply this standard of control in implementing the restrictions described above. According to the ENRE resolutions, a company controlled by or controlling an electric power transmission company is a company that owns more than 51% of the voting shares of the controlled company and exercises a majority control.

Both electric power transmission and distribution companies are also subject to horizontal restrictions. The horizontal restrictions applicable to transmission companies are the following:

- Two or more transmission companies can merge into or be part of a same economic group only if they obtain an express approval from the ENRE; such approval is also necessary when a transmission company intends to acquire shares in another electric power transmission company;
- Pursuant to the terms of the concession agreement that governs the transmission of electric power through transmission lines above 132 kV and below 140 kV, the transmission service is rendered exclusively in the specific areas indicated in such agreement; and
- Pursuant to the terms of the concession agreement of the company that renders electric power transmission services through lines with voltage equal to or higher than 220 kV, the service must be rendered exclusively and without territorial restrictions, throughout Argentina.

The horizontal restrictions applicable to electric power distribution companies are the following:

- Two or more distribution companies can merge into or be part of a same economic group only if they obtain an express approval from the ENRE; such approval is also necessary when a distribution company intends to acquire shares in another electric power distribution company; and
- The distribution service is rendered within the areas specified in the respective concession contracts.

#### **Distributed Self-Generator; Resolution SE No. 269/08**

Through Resolution No. 269/08, the former Secretariat of Energy established the classification of Distributed Self-Generator, consisting of a power electricity consumer that also generates electricity and has its consumption and generation points connected to the SADI at different connection nodes. Such resolution sets forth that:

- In accordance with Annex 12 of “The Procedures”, a Distributed Self-Generator must meet the same requirements and execute its transactions in the WEM in the same way as a Self-generator.
- The generation associated with any Distributed Self-Generator that wishes to become a WEM agent must have been commercially enabled to that end after the enactment of Resolution SE No. 1281 on September 4, 2006.
- A Distributed Self-Generator may have two or more connection points with the SADI for generation, consumption, or both, all associated with the same Distributed Self-Generator. As a consequence, point 2 b) of Annex 12 of “The Procedures” shall not apply to Distributed Self-Generators.
- All requirements related with the generation and consumption of Self-Generators in accordance with the definition set forth in Annex 12 of “The Procedures” shall be understood, in the case of Distributed Self-Generation, as applicable to the sum of the generation plus the sum of the consumption, respectively.
- If any, only connection points that have both generation and consumption shall have to comply with the provisions set forth in point 2 b) of Annex 12 of “The Procedures”. The other connection points with SADI that have only generation or consumption shall have communications and data exchange systems with the OED similar to those required of Generators or users with equivalent characteristics, respectively.
- Whenever the generation levels exceed the consumption levels of a Distributed Self-Generator, or have the capability thereof, the Distributed Self-Generator will be considered to have a power energy surplus. In that case, the Distributed Self-Generator will be able to sell such surplus to the WEM.
- As regards any purchase possibility, Distributed Self-Generators shall be treated as large users of the WEM for each consumption connection point. Their demand will be calculated taking into account that, on an hourly basis, the energy demand is equal to the sum of the consumption minus the sum of the

generation, and the same is consumed at the consumer connection point in proportion to such net consumption.

- In regards to the participation of Distributed Self-Generators as consumers of the WEM, every purely consumption point of such Distributed Self-Generators shall pay the same charges as large users of the WEM , taking into account the calculation explained in the previous paragraph.
- In case of a breach of its dispatch commitments to the WEM in accordance with its contracts, it will be considered to purchase such shortage in terms of the regulations in force.
- A Distributed Self-Generator can only have purchase agreements in its capacity as generator or in its capacity as consumer. That is to say, it may not simultaneously have purchase agreements as generator and consumer within a contract at the same time.

### **Regime of Promotion to the Distributed Generation of Renewable Energy Integrated to the Electricity Network Public: Law No. 27,424**

Law No. 27,424 established the “Regime of Promotion to the Distributed Generation of Renewable Energy Integrated to the Public Electric Network”, in order to achieve energy efficiency, the reduction of leakage in the interconnected system, the reduction of costs for the electrical system as a whole, the environmental protection provided for in article 41 of the National Constitution and the protection of consumer rights regarding equity, non-discrimination and free access to power transmission and distribution services and premises.

To that end, that regime regulates the generation of renewable electricity by users of the distribution network, for self-consumption, with the injection of eventual surpluses into the network, being the providers of the public distribution service forced to facilitate such injection, ensuring the free access to the distribution network.

Every user-generator has the right to install equipment for the power generation from renewable sources up to a power equivalent to the one it has contracted with its distributor to satisfy its own demand, subject to prior written authorization by the distributor. Once authorization is granted, the user-generator and the distributor shall execute an electricity generation agreement to govern such relationship.

In addition, the Fund for the Distributed Generation of Renewable Energies (“FODIS”) was created, which will be established as an administrative and financial trust, having as its object the application of the trust assets for granting loans, incentives, guarantees, capital contributions and acquisition of other financial instruments, all of them intended for the development and implementation of distributed generation of renewable energies systems.

The Argentine government shall be the settlor of the FODIS, while the public bank selected by the settlor shall be the trustee.

The beneficiaries shall be those individuals domiciled in Argentina and the legal entities registered in the country whose distributed generation projects have been approved by the FODIS.

Law No. 27,424 also created the Promotion Regime for the National Manufacturing of Systems, Equipment and Supplies for distributed generation from renewable sources (“FANSIGED”) under the Ministry of Production.

The purpose of the FANSIGED is to engage in: research, design, development, investment in capital goods, production, certification and installation services for the distributed generation of energy from renewable sources.

Micro, small and medium-sized companies incorporated in the Republic Argentina that develop some of the aforementioned activities as their main activity will be able to adhere to the FANSIGED.

The FANSIGED establishes that each distributor must calculate the compensation and administer the remuneration for the energy injected into the network as a result of the distributed generation of electricity from renewable sources under the net billing model, taking into account that: (a) the user-generator will receive an injection



rate for each kilowatt-hour delivered to the distribution network, who will purchase, recognize and, if applicable, pay the user-generator all the energy it injects into the network of distribution generated from renewable sources; in the invoice the distributor will read the energy demand and the injection to be recognized in that invoice; (b) the value of the injection rate of each user-generator shall apply from the time of installation and connection by the distributor of the measuring equipment; (c) the distributor must reflect in the invoice issued for the electric power service provided to the user-generator, both the volume of the energy demanded and that of the energy injected into the network by the user-generator and the corresponding prices, each per kilowatt-hour, the user-generator will pay the Distributor the result of the net calculation between the monetary value of the energy demanded and that of the energy injected before taxes. This compensation is made at peso value; (d) in the event that a credit or monetary balance is generated in favor of the user-generator in a certain billing period, it will be automatically charged to the following billing period, and, if any credit remains in favor of the user-generator, the latter can request the payment of the favorable balance accumulated in its user account; the settlement of the favorable balance may be made by electronic means, and the distributor is required to settle and pay it at least in two fixed annual instances. In the event that the user-generator does not express its will regarding the balances in its favor, they shall be accumulated in its account, without expiration date; (e) in the cases of co-owners of condominiums or real estate complexes, the co-owners' association shall be the owner of the receivable; (f) the user-generator is allowed to transfer or assign credits from the energy injection between users of the same distributor and the distributor cannot add any additional charges for maintenance of the network, access toll, electric backup or any item related to the installation of equipment for distributed generation.

The rule also establishes that the profits derived from the activity of injection of distributed electrical energy, generated from renewable energy sources, by users-generators that have 300kW maximum power contracted and that satisfy the requirements and other authorizations determined in the rule, shall be exempted from income tax. The sale of injected energy shall also be exempted from VAT.

Furthermore, Resolution SGE No. 314/18 created the Federal Registry of Generators-Users of Renewable Energies for registration of distributed generation projects from renewable sources that have obtained the corresponding Generator-User Certificate (issued by the Undersecretariat of Renewable Energy and Energy Efficiency that evidences compliance with all the necessary requirements to connect a Distributed Generation Equipment) for reporting purposes, in connection with the satisfaction of the goals of the distributed generation regime.

Furthermore, this regulation established that the WEM distributors that provide the electric power distribution public service, should disclose to the Dispatch Organization, on a monthly basis, the values corresponding to the energy injected by the users-generators into the distribution network as a result of the energy surplus generated by renewable sources.

Finally, in exercise of the power granted through section 1 of Exhibit I of Regulatory Decree No. 986/2018, the Undersecretariat of Renewable Energies and Energy Efficiency reporting to the Ministry of Economy, issued Regulation No. 28/2019 (published in the Official Gazette on March 1, 2019) approving the supplementary rules of the Regime of Promotion of Distributed Generation of Renewable Energy Integrated to the Public Electric Network.

## **Evolution of Supply and Demand in the Argentine Energy Sector Structure**

### ***Structural Characteristics of the Energy Sector***

The evolution of energy demand and consumption in Argentina is correlated with the evolution of GDP, which implies that the higher the economic growth, the higher the energy demand. The historical growth of energy consumption was of 3.05% annually over the past 57 years, with an annual average of 3.65% since 2002, although recently the economic growth rose to an average of 4.08% annually.

The growth of energy consumption during the last decade is similar to the historical average, since it was not driven by a large increase in consumption by the industrial sector, but predominantly by the residential and commercial sectors, as noted in the consumption parameters of gas, gasoline and especially electric power.

The elasticity of energy consumption in relation to GDP during the last two decades is lower than in earlier decades. As such, restrictions on energy demand or the need for energy imports, if domestic supply is insufficient, could increase if the industrial sector expands in the future.

The restrictions on the supply of certain energy products such as natural gas in the last cycle of high economic growth and the relatively moderate growth in energy demand in broad terms, are based primarily on problems related to the supply of these energy products and also on a significant growth of the demand of the residential and commercial segments in a context of modest industrial recovery, but with few new expansions of greater productive capacity for large energy consumers.

The structure of energy consumption in Argentina is strongly dependent on hydrocarbons, at almost approximately 65%. This percentage has decreased in the last three to four years due to the obligation imposed by the regulators to incorporate biodiesel and bioethanol into oil and gasoline.

Large amounts of natural gas, liquefied natural gas (“LNG”) and gasoil are imported in order to try to satisfy demand. However, demand for natural gas is usually unsatisfied during the winter in the industrial segment and in the thermoelectric generation segment. In certain circumstances, the Argentine government has imposed restrictions on consumption because of the lack of adequate supply of gas to supply other segments that do not have the capacity to replace natural gas with other fuels (among others, propane, butane and fuel).

Although current energy consumption in Argentina signals a dependence on hydrocarbons, we believe that Argentina is currently undergoing an important historical shift to a modern and diversified energy mix arising from the inclusion of renewable energy into the mix, in accordance with the requirements set forth in Renewable Energy Law of 2015.

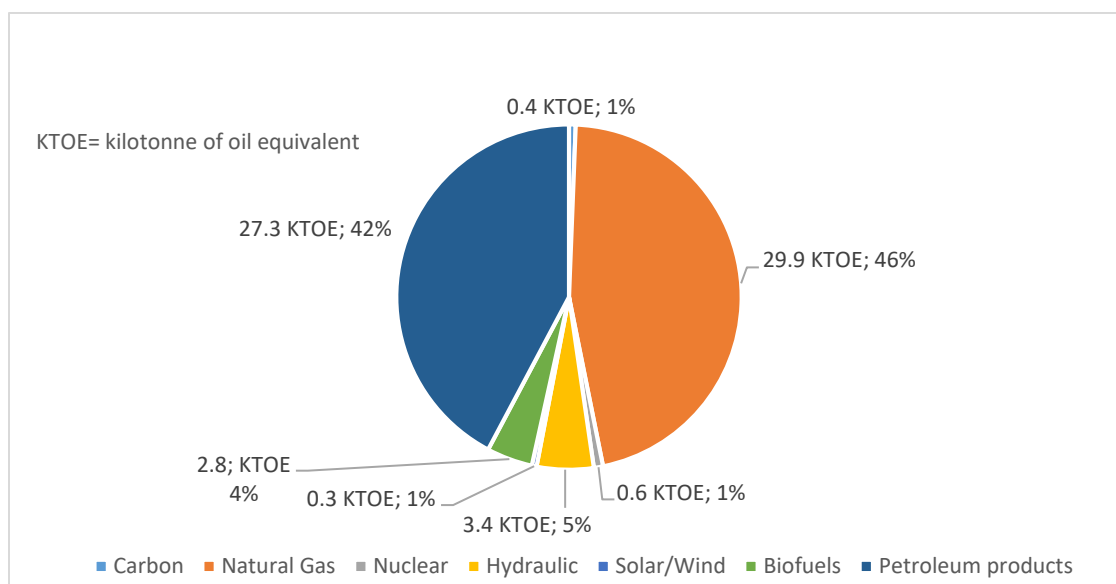

Source: own development with information from the International Energy Agency (until 2016) and CAMMESA.

As a summary, the following characteristics are specific to energy demand and supply in Argentina:

- A typical structure, with a bias towards oil and gas, which is a characteristic of countries with large reserves of hydrocarbons such as Middle Eastern countries, Russia, African oil-producing countries and Venezuela.

- 55% of the energy supply is dependent on natural gas despite significant restrictions imposed on electric power generators and the penetration of gas consumption in the energy market, which is higher than in most countries that have a large surplus production of natural gas.
- Stagnation in the local energy supply since investments in recent years in the oil and gas sector have been insufficient to effectively increase domestic supply enough to satisfy a nearly ever-increasing demand.
- Enhanced demand due to the abnormally low prices of gas and electric power in the residential and commercial sectors during the 2012-2015 period, which caused the growth rate of residential energy consumption to be higher than usual, whereas of 2016 they are attenuated according to the different tariff adjustments of the sector.

### **Structure of the Electric Power Supply in Argentina**

The nominal installed capacity in Argentina is reported by CAMMESA to be 36,859 MW as of February 2018. However, the operational electric power generation capacity effectively available at any given time could be estimated at around 29,018 MW as an average in February 2018, representing approximately 78.7% of the nominal capacity due to the lack of proper fuel supply, difficulties in achieving nominal efficiency and unavailability of several generating units under maintenance. Moreover, the generation supply depends on liquid fuel use during winter that diminishes capacity availability and there are certain transmission restrictions.

Over recent decades, the Argentine government has favored the deployment of thermoelectric generating units. One reason for this is that these units require smaller capital investments and take less time to deploy. The increased dependency on hydrocarbons for these new power plants was not considered a disadvantage, since the required fuels have always been produced in Argentina and the production has always been predictable and growing. However, the constant deployment of thermoelectric generation has increased the demand for fossil fuels, particularly those based on natural gas, and has led to shortages and the imposition of certain restrictions on the provision to thermal generators of locally produced fuels.

In the 1990s, private sector investors also concentrated their investments in thermoelectric generation, almost without exception. The economic crisis of 2002 further accelerated the tendency to invest in thermoelectric plants, given their lower startup costs. After the crisis of 2002, investments in the electrical sector continued mainly with state intervention, expanding the installed capacity based on thermoelectric generation but without meeting the increasing demand. The financial constraints of the Argentine government in the last decades, the high amount of capital needed and the long periods necessary to develop the projects have negatively impacted the decision of the Argentine government to invest and deploy hydroelectric and nuclear power plants. In addition, the recurrent fiscal crises of the recent past have forced the Argentine government to delay or cancel major projects that would have increased and diversified Argentina's generation capacity.

The growth of the Gross Nominal Installed Power during the last decade has been dominated by the thermoelectric power generation. The supply of hydraulic generation grew 46.00% in the last 20 years due to the gradual incorporation of three hydroelectric plants: Yacyretá, Piedra del Aguila and Pichi Picún Leufú. For its part, the supply of thermoelectric generation grew 172.00% in the same period.

In December 2015, the emergency with respect to the national electricity sector was declared until December 2017 and, therefore, the former MEyM elaborated a program of necessary actions to be taken in relation to the generation, transport and distribution of electric power, in order to adapt the quality and safety of the electricity supply, guaranteeing the provision of public electricity services under conditions technically and economically adequate. To that end, efforts were made to mitigate the firm power deficit through open call for generation contracting carried out in the framework of Resolution No. 21. It was also considered appropriate and convenient to make adjustments to the remuneration scheme of the existing generators, according to the guidelines established by Resolution No. 19.

Furthermore, in order to reduce costs and increase the reliability on the Electric System and, therefore, the supply in the WEM and begin the process to reassign the responsibility for the supply of fuel for electric power

generation to the WEM generators, a participation process was established to identify solutions through a call for a bid to develop electric power projects to satisfy such goals. As a result, Resolution No. 287 called for bids to build new thermal combined-cycle and cogeneration units to satisfy the demand in the WEM.

The bids awarded within the bidding process called by Resolutions No. 21 and No. 287 executed wholesale demand contracts to cover WEM demand requirements for a total capacity of 5,359 MW.

To comply with the minimum requirements established in the Renewable Energy Law and considering the opportunity of expansion of the use of renewable energy sources destined for the production of electric power diversifying the energy matrix and increasing the installed power capacity, reducing the consumption of fossil fuels and the emission of greenhouse gases, and contributing to mitigate climate change “RenovAr Program” began offering PPAs to meet the demand of the WEM for a total capacity of 4,466 MW, with an increasing participation of wind and solar technologies; the schedule ranges for these PPAs from 2017 to 2020, respectively, and also sets forth the supply of power derived from renewable sources through private agreements to satisfy the conditions set forth in the Renewable Energies Law.

### ***Nominal Power Generation Capacity***

Nominal power generation capacity is dominated by thermoelectric generation. A considerable number of thermoelectric power units experience high levels of unavailability, especially during the winter, due to fuel provision restrictions.

During the winter of 2017, the local power availability on the day of the peak demand reached 23,738 MW plus 1,694 MW of spinning reserve. Only 1 MW was imported during the winter, which had moderate temperatures throughout the country. In the summer of 2016, the maximum power consumed reached 25,380 MW on February 12, according to CAMMESA. On that date, the generation capacity available in Argentina was 23,496 MW plus a spinning reserve (which consist of a pool or machines that can dispatch 1,614 MW, if needed, but only 280 MW can be dispatched immediately, if necessary), so CAMMESA had to make additional energy imports by 1,884 MW.

According to CAMMESA, the historical maximum power and energy are as follows:

### ***Historical Maximum of Power and Energy***

On December 27, 2015 the historical maximum of power for SADI on a Sunday was exceeded (21,973 MW at 10.33 pm).

In the eighth week of 2017, the historical maximum of weekly energy was exceeded (3,436.8 GWh).

On December 30, 2017, the SADI’s historical power and energy maximums on a Saturday were surpassed (22,543 MW at 2.52 pm and 478.4 GWh, respectively). In December 2017, the net demand of energy of the WEM registered an increase of 1.2% with respect to the value reached in the same month of the year past.

On February 26, 2017 the SADI’s historical energy maximum on a Sunday was surpassed (437.6 GWh).

On February 8, 2018, the SADI’s historical power and energy maximums for a business day were exceeded (26,320 MW at 3.35 pm and 543 GWh, respectively).

<b>Historical Maximum of Power and Energy</b>						
<b>Days</b>	<b>Business Days</b>		<b>Saturday</b>		<b>Sunday</b>	
	<b>Power MW</b>	<b>Energy GWh</b>	<b>Power MW</b>	<b>Energy GWh</b>	<b>Power MW</b>	<b>Energy GWh</b>
<b>Maximum</b>	26,320	543	22,543	478.4	21,973	437.6
<b>Date</b>	February 8, 2018	February 8, 2018	December 30, 2017	December 30, 2017	December 27, 2015	February 26, 2017
<b>Time</b>	3.35 pm	-	2.52 pm	-	10.33 pm	-

<b>Medium Temperature in Buenos Aires</b>	30.2 °C	30.2 °C	31.2 °C	31.2 °C	28.3 °C	29.4 °C
---	---------	---------	---------	---------	---------	---------

<b>Week</b>	No. 8
	February 20, 2017 to February 26, 2017
<b>Maximum</b>	3,436.8 GWh

Source: CAMMESA.

There are three main centers of electric power supply in Argentina:

- Buenos Aires-Greater Buenos Aires-Coastline
- Comahue
- Northeast Argentina

Electric power supply and demand were linked in the past by a radial system to Buenos Aires. This system presented risks of instability in various regions whose demand had grown but had insufficient local generation (*e.g.*, Cuyo, Northwest Argentina in Salta, Central and Greater Buenos Aires). For this reason, the Argentine government changed the system and now is using a peripheral system. The Argentine government has made very large investments in a substantial expansion of electric transmission, totaling 500 kV. Such investments include laying peripheral high voltage lines totaling 500 kV (that may not have an immediate economic impact but will have positive effects on the system in the long term) in the following locations:

- Northeast and northwest Argentina
- Comahue-Cuyo
- Southern Patagonia

A public private participation project for the construction of new high voltage electric transmission lines is currently underway. This project includes approximately 10 transmission lines and complementary works in three stages.

The dates of bidding are the following:

- Stage 1: September 5, 2019
- Stage 2: to be determined
- Stage 3: to be determined

The following chart shows the development of electric power generation by type of source:

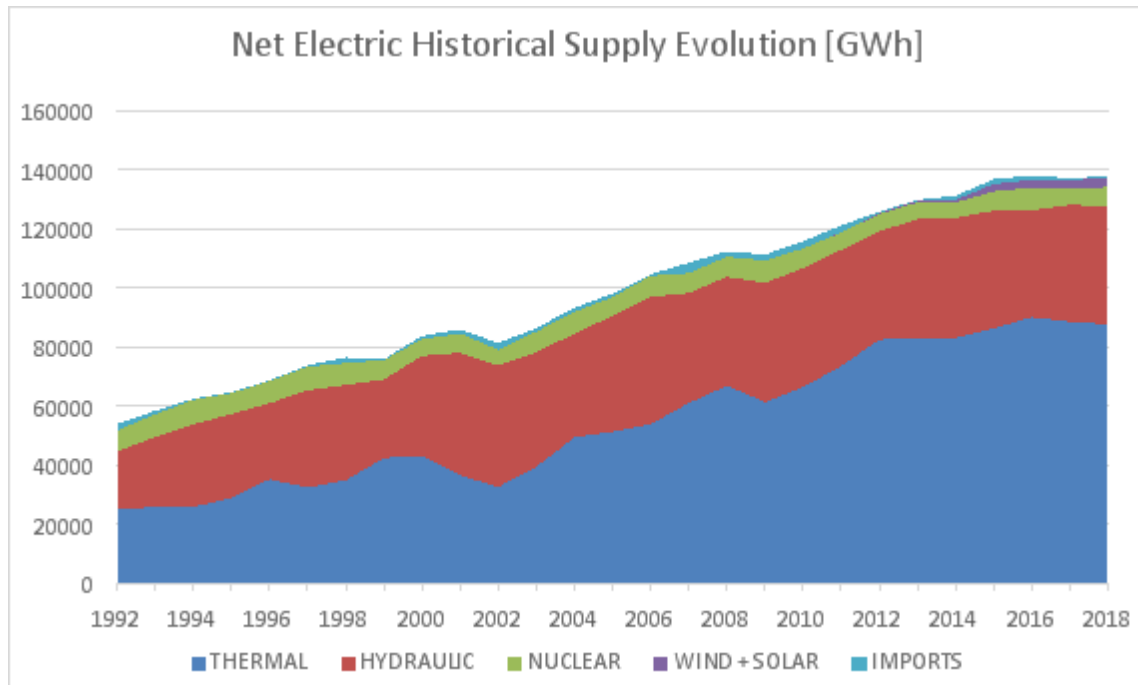

Source: CAMMESA.

The total net national generation connected to the SADI in December 2017 (nuclear, hydraulic, thermal, wind and photovoltaic) was 1.7% higher than December 2016 and 16.4% higher than the previous month.

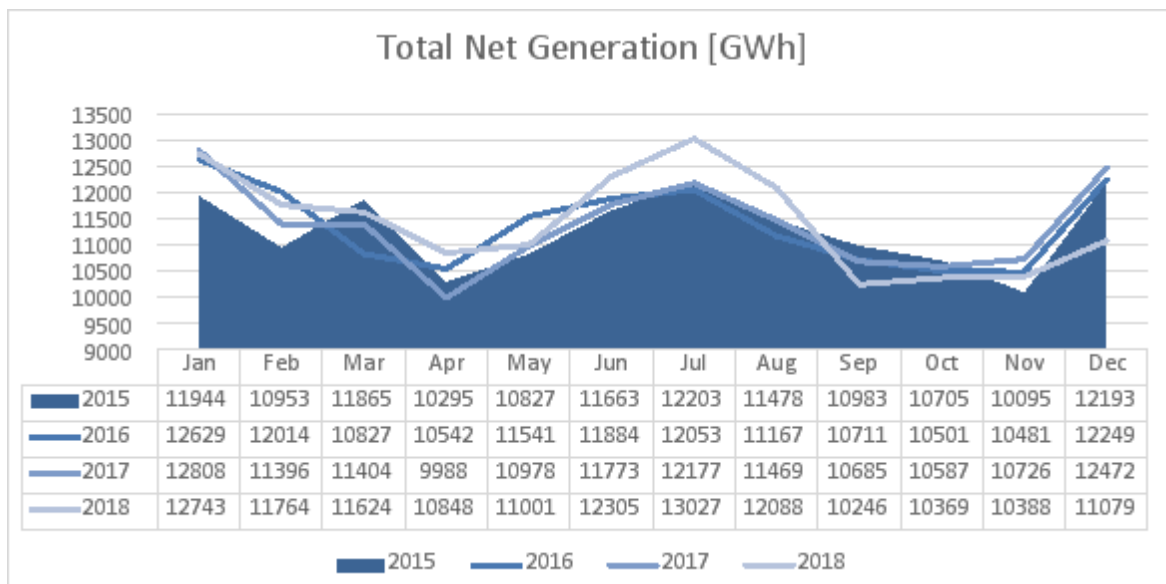

Source: CAMMESA.

The following graph shows the relationship between the different sources of generation is presented:

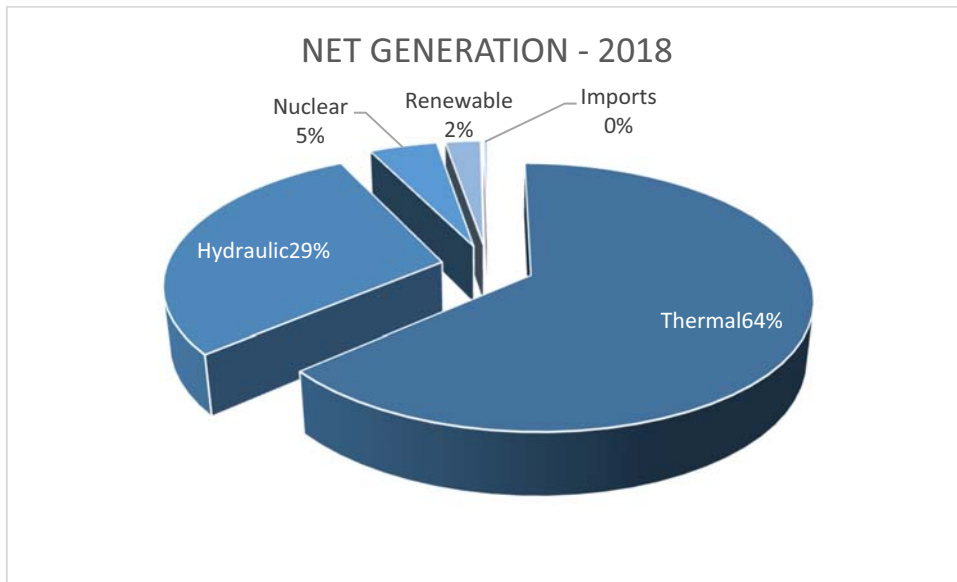

Source: CAMMESA.

The generation of renewables, which is shown in the preceding graphs, includes wind generation, photovoltaic, from hydroelectric power less than 50 MW, and from biogas and biomass plants incorporated at the moment.

The largest percentage of this value corresponds to hydraulic generation of less than 50 MW, which is followed by hydraulics less than 30 MW, and then wind.

### **Electric Power Demand in Argentina**

Electric power demand depends to a significant extent on economic and political conditions prevailing from time to time in Argentina, as well as seasonal factors. In general, the demand for electric power varies depending on the performance of the Argentine economy, as businesses and individuals generally consume more energy and are better able to pay their bills during periods of economic stability or growth. As a result, electric power demand is affected by Argentine governmental actions concerning the economy, including with respect to inflation, interest rates, price controls, foreign exchange controls, taxes and energy tariffs.

The following chart shows the demand for electric power in 2018 by customer type:

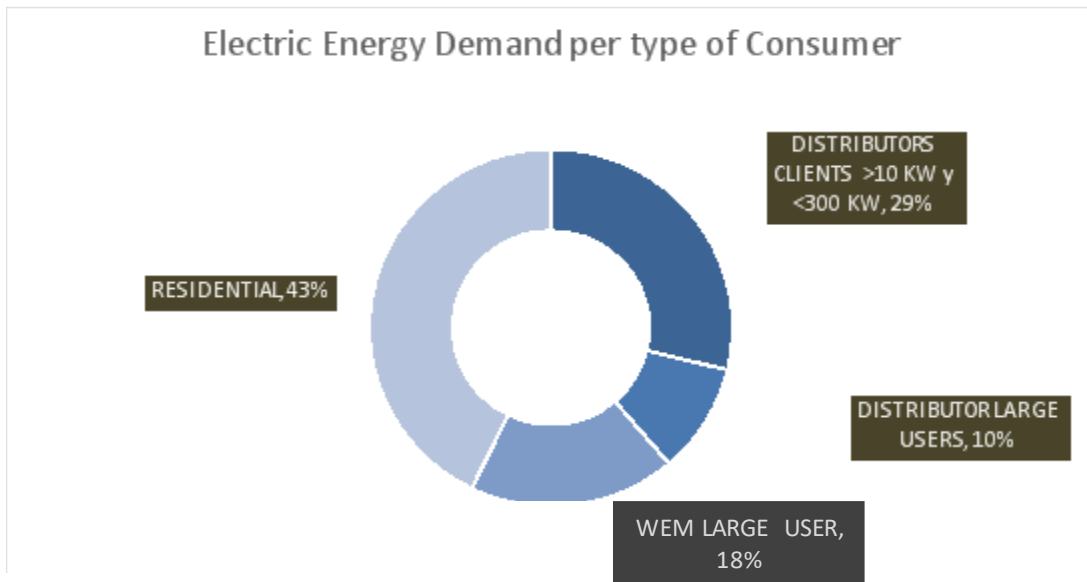

Source: CAMMESA.

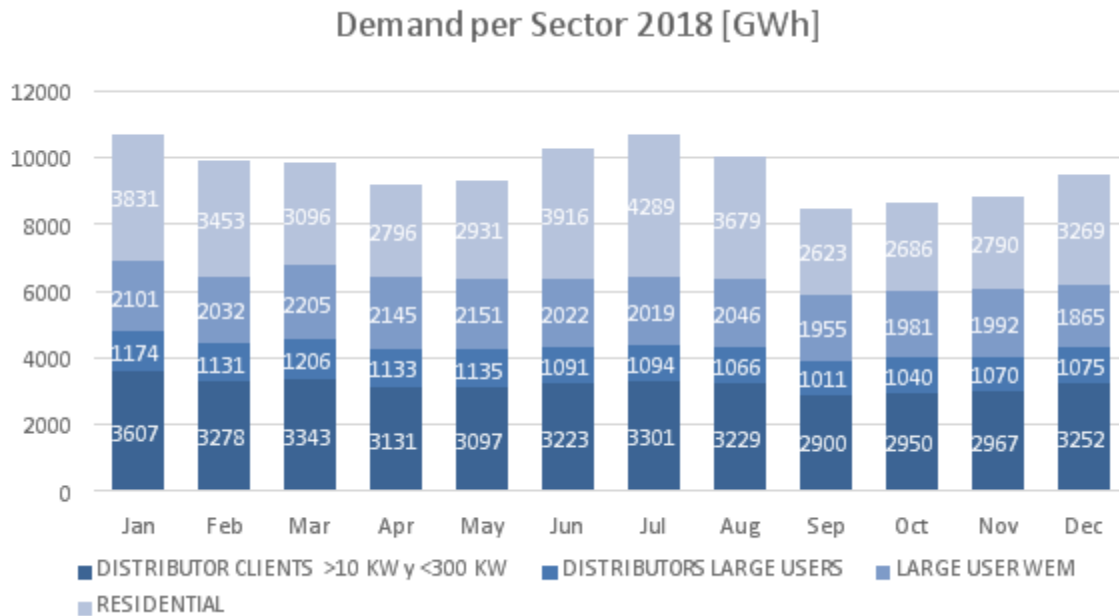

Source: CAMMESA.

The following chart shows the inter-annual comparison of the electric demand by types of user, according to the most recent information available.

The correlation between the evolution of GDP and electric power demand is strong, although when there is a strong reduction of GDP, electric power demand falls relatively little. In addition, in an environment of low economic growth, electric power demand grows at rates higher than GDP, as shown below:



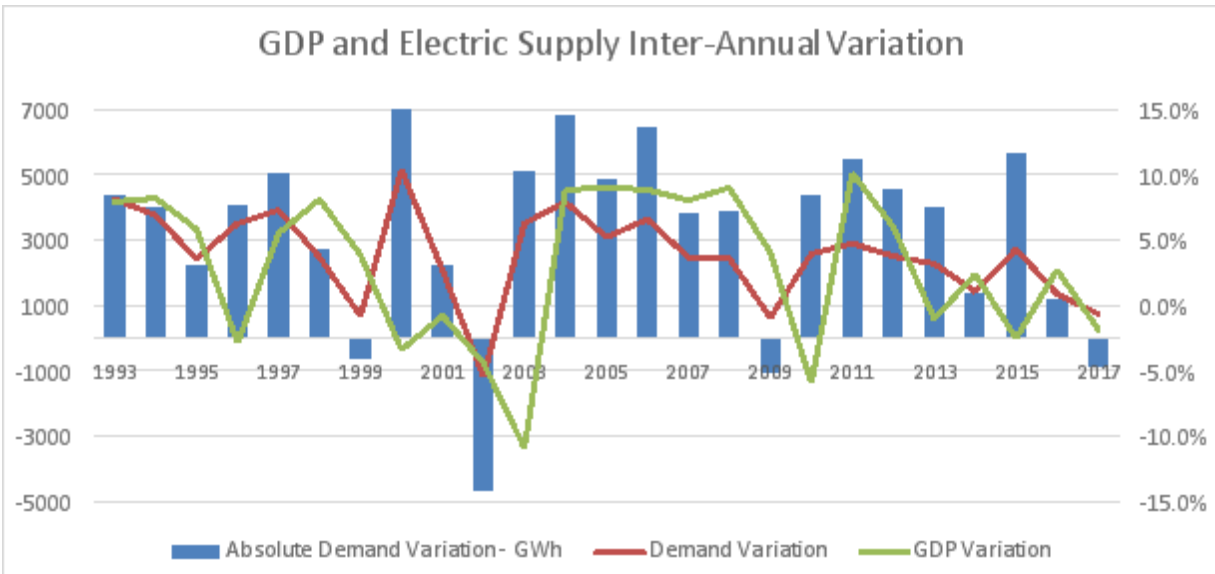

Source: own development with information from CAMMESA and World Bank.

CAMMESA divides Argentina into regions that have similar characteristics in terms of demand, socio-economic characteristics and electric subsystems. Such regions are: (i) the City of Buenos Aires and Greater Buenos Aires, (ii) the Province of Buenos Aires, (iii) Santa Fe and northwest Buenos Aires, (iv) the Center, (v) the Northwest, (vi) Cuyo, (vii) the Northeast, (viii) Comahue and (ix) Patagonia.

Demand is significantly concentrated in the areas of the City of Buenos Aires, the Province of Buenos Aires, Santa Fe and northwest Buenos Aires, which comprises approximately 61% of the demand. While growth rates in other regions such as the Northwest, Comahue and Patagonia are higher compared to the rest, changes to the concentration of the demand structure are not substantial over the period of measurement.

Seasonality also has a significant impact on the demand for electric power, with electric power consumption peaking in summer and winter. The impact of seasonal changes in demand is registered primarily among residential and small commercial customers. The seasonal changes in demand are attributable to the impact of various climatological factors, including weather and the amount of daylight time, on the usage of lights, heating systems and air conditioners.

The impact of seasonality on industrial demand for electric power is less pronounced than on the residential and commercial sectors for several reasons. First, different types of industrial activity by their nature have different seasonal peaks, such that the effect of climate factors on them is more varied. Second, industrial activity levels tend to be more significantly affected by the economy, and with different intensity levels depending on the industrial sector.

Energy demand throughout the hours of each month grew in 2006 reflecting a sharp increase in industrial activity and mass consumption in the economy. Such demand declined due to restrictions on industrial power consumption in the winter of 2007, and the international crisis at the end of 2008 and early 2009. However, such decline in consumption has reversed since mid-2011 due to a growth in demand as evidenced by the 12 month moving average.

A direct annual analysis—as opposed to a 12 month moving average, which is useful to show inertial trend changes (*i.e.*, the underlying trend that includes only a few months and therefore better shows gradual changes to stability)—shows growth rates in energy demand during 2010 and early 2011, with an abrupt slowdown (including negative values) in 2012 and, after the winter of 2012, an increase in energy demand during 2013. In December 2013 and January 2014, there was exponential growth in demand by residential and commercial consumers due to the heat wave that hit the central region of Argentina during those periods. In December 2014, the demand growth trend was reversed with a sharp drop in demand with the return of normal temperatures.

The demand for electric power in the residential sector resumed a high growth trend in 2015. Following moderate growth, gross aggregate demand grew 1.20% in 2014. In 2015, gross demand increased 4.5%, despite moderate increases in rates to a small portion of consumers. During the first half of 2016, gross demand increased 3.8% as compared to the same period the previous year, maintaining consumption values for the rest of the year. In 2017, the demand decreased in the residential sector due to the continuous tariff adjustments that are compensated by the growth of the commercial segment that maintained the records in similar conditions to the previous year.

In addition to the growth of energy demand, which places pressure on the supply of fuels to thermal plants, demand also affects the availability of generation plants to meet peak demand for power at nighttime during the winter or during the afternoon in the summer.

To minimize the risks of sudden interruptions to the residential and commercial segment in 2013, there were scheduled supply interruptions in December 2013 and January 2014, which were similar to what occurred in the winter of 2010 and 2011, but did not reach the extraordinary levels of the winter of 2007. No interruptions were necessary in 2012. During the summer and winter of 2015, it was not necessary to apply restrictions to industrial consumers to supply residential electric power demand, although there were some forced interruptions due to certain problems with electrical distribution. However, during February 2016, certain restrictions to consumption of an approximate amount of 1,000 MW were applied by CAMMESA and the former MEyM due to the above average temperatures recorded in February 2016.

During February 2018 there were high peaks of consumption of electric power for a business day. The maximum peak of consumption of 26,320 MW was reached on February 8, 2018 having optimal spinning reserve conditions to cover the electrical system and without import values compared to records of coverings of previous peak, particularly highlighting the incorporation of 1,800 MW as additional installed thermal power capacity through Resolution No. 21 during 2017. Restrictions were implemented to the demand of the distributors in the City of Buenos Aires, Greater Buenos Aires and the city of La Plata.

In addition to the specific demand in the afternoon during the summer of 2018-2019, there were energy consumption records throughout the day. The consumption record of approximately 544 GWh per day was reached on January 29, 2019 with the abovementioned restrictions on demand, which did not significantly influence the theoretical maximum demand.

As with the case of natural gas, the strong seasonality of electric power demand in Argentina—both in terms of energy and power—influences the needs for investment since investments are made to meet the maximum peak winter demand, which generates significant *surpluses* at other times of the year that cause lower costs and competition in those periods. The maximum demand for electric power is during the evening hours in summer. In the case of winter, the increased demand is due to the high use of electric heaters that are preferred by consumers because of the differential cost and simplicity in comparison with natural gas heaters.

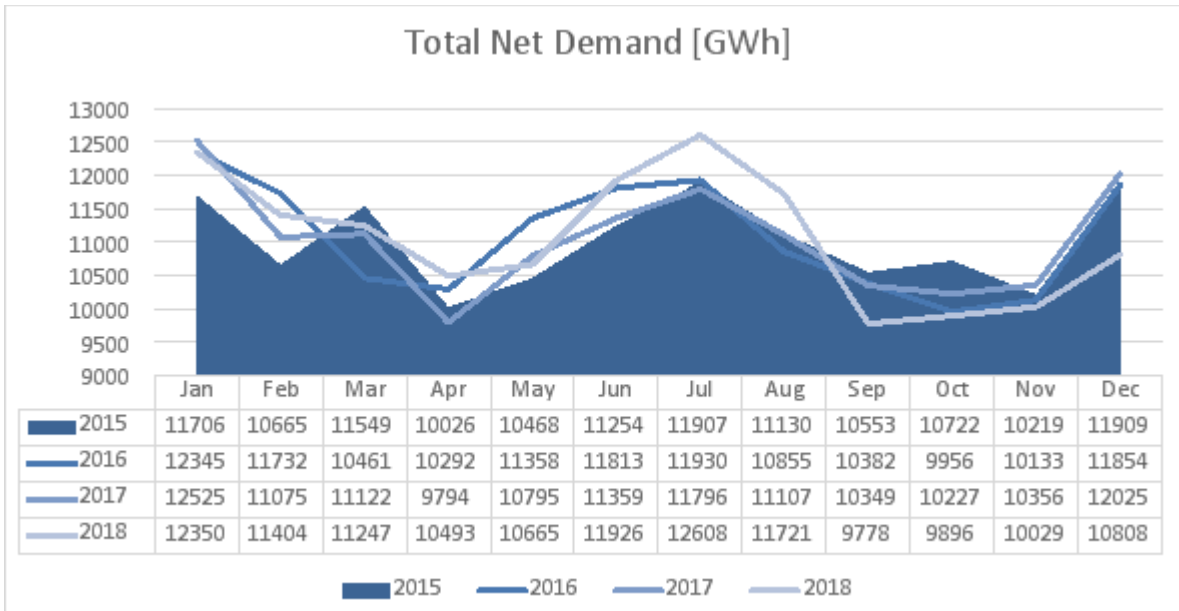

Source: CAMMESA.

Notwithstanding the official data of the nominal installed capacity for power generation detailed above, this generation capacity is not actually available at times of peak demand. Both in summer and especially in winter, there is an effective generation capacity to meet the demand.

The availability of thermal power plants continues to improve due to both technical issues and the lack of conditions to improve the available supply of natural gas and, in turn, remunerative conditions that benefit the operation of the sector.

Despite all efforts, it is unlikely for there to be complete nominal capacity available at any given time. Instead, the power generation capacity industry generally anticipates and takes into account a percentage of unavailability that can range between approximately 25% and 30%, which is likely to increase in the coming years.

### THERMAL PLANT AVAILABILITY

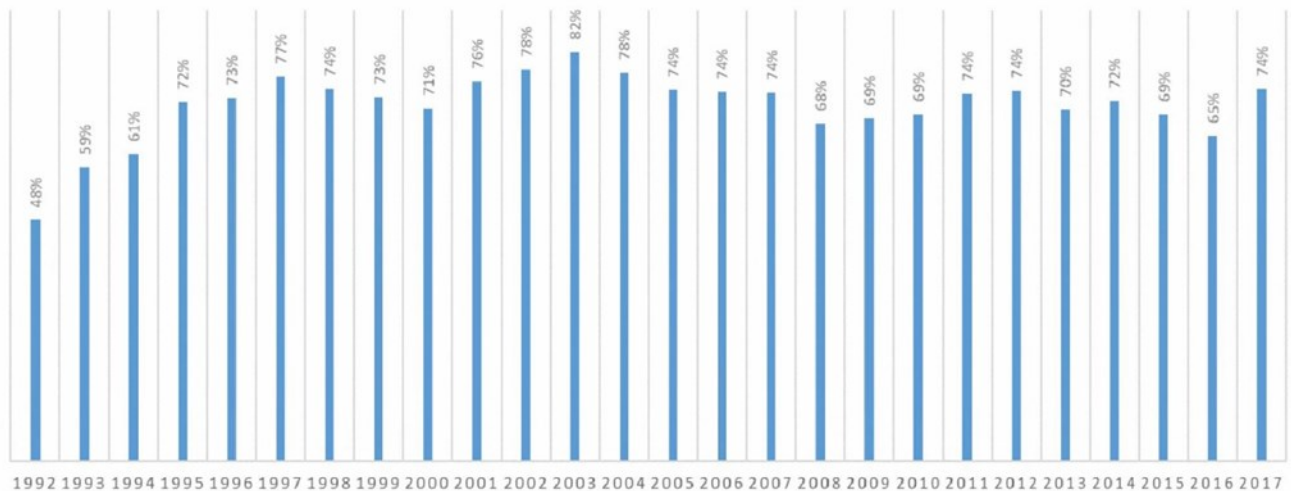

Source: CAMMESA.

This critical variable is central to the efforts made by CAMMESA and the generators to invest in the proper maintenance of the units. Although the unavailability factor over the long-term in the thermal plants in Argentina has historically been approximately 30%, it fell below 20% for a period in the early 2000s. In general, the unavailability factor of the hydroelectric plants in Argentina is not significant, except for the existing damage in the turbo groups of Yacyretá. In the nuclear sector, historical unavailability has been important because of the periodic maintenance that units have to go through. In particular, since January 1, 2016, the Embalse nuclear plant has been inoperative for three years. Additionally, the Atucha II nuclear plant, which began generating energy on a trial basis in 2015, received its commercial authorization during the first half of 2016, adding a nominal capacity of 745 MW to the SADI.

Energy generation may be influenced by the physical and economic capacity to provide fuel to thermoelectric generators. Until 2014 and since 2017, fuel prices increased the generating cost, although the fall in oil and fuel prices significantly reduced such cost in 2015 and 2016. The lack of local production of natural gas led to an increased use of fuel oil and gasoil in those generating plants with steam turbines and gas turbines units, in addition to imports of gas and LNG. Most of the steam turbines units are shipped with fuel oil, and only the Central Térmica San Nicolas can burn coal, in addition to fuel oil or natural gas. Steam turbines or gas turbines that operate in Combined Cycle are included in this area in previous tables.

Fuel availability is a factor that contributes to technical unavailability. The costs and logistics for importing and supplying fuel oil, gasoil, and coal instead of natural gas are key to the future availability of thermal units, and will continue to be important if the current international conditions are maintained. Since 2007, the limited supply of natural gas in winter caused a large increase in consumption of fuel oil and gasoil, with record prices in the first half of 2008. Prices decreased in 2009 due to the international crisis and then increased in 2010 (while remaining lower than in 2008).

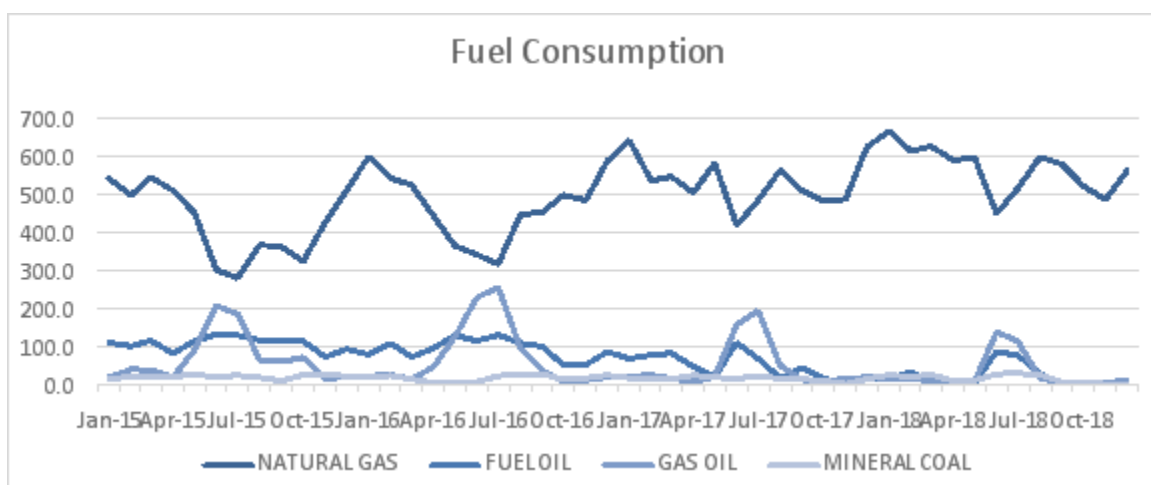

Source: CAMMESA.

The following charts contain projected energy demand and installed capacity in the Argentine power market for the next nine years:

## DEMAND (GWh)

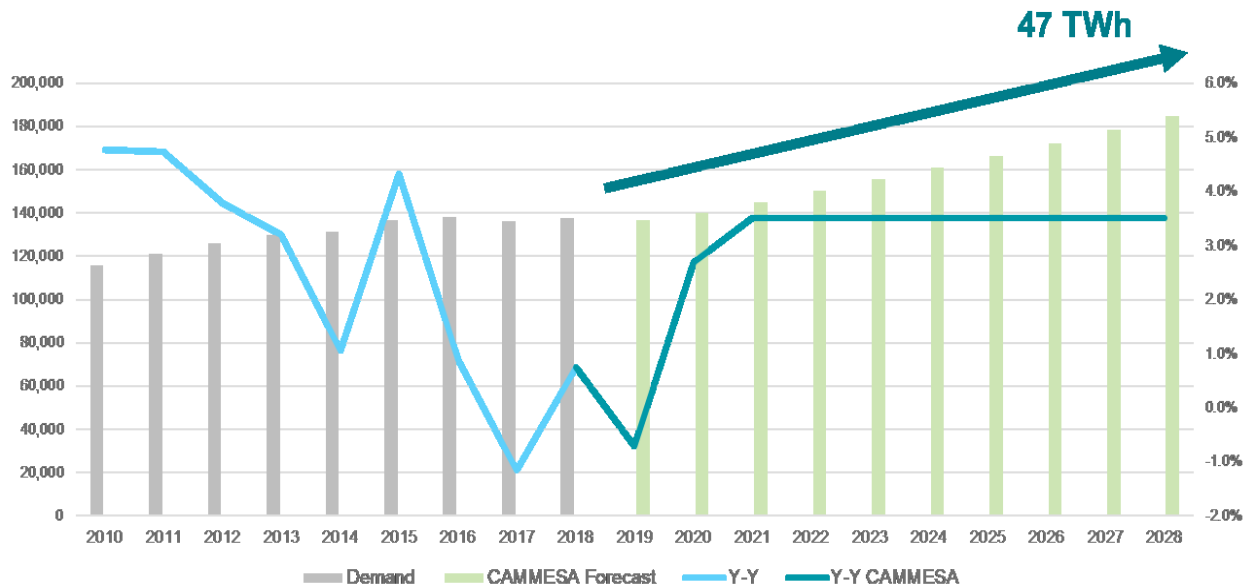

Source: own development with information from CAMMESA.

## INSTALLED CAPACITY (MW)

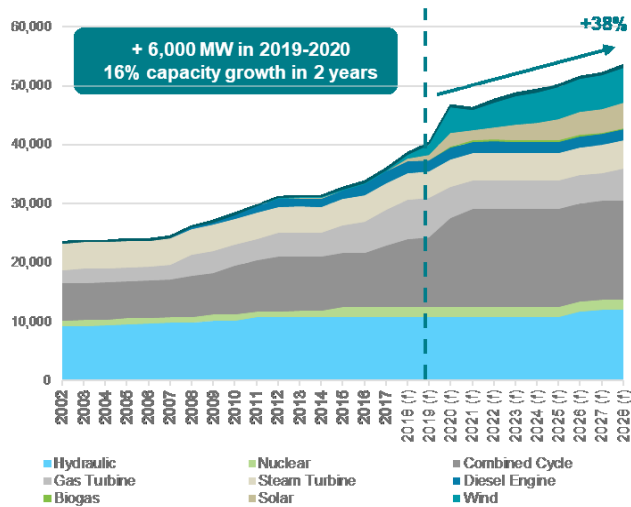

## Growing renewable capacity

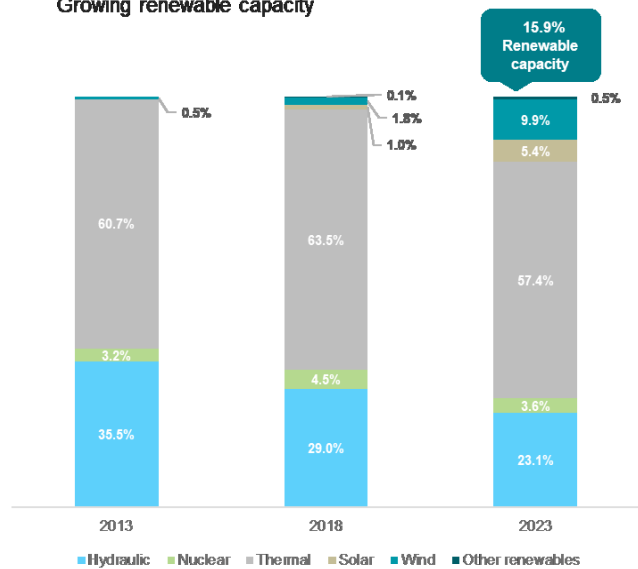

Source: own estimates with information from CAMMESA.

## Anti-Money Laundering and Terrorism Prevention Regulations

Modifications to Argentine money laundering regulations have resulted in their application to increasing numbers and types of securities transactions.

The notion of money laundering is generally used to refer to transactions aimed at introducing funds derived from unlawful activities into the institutionalized system and therefore, transforming profits obtained from unlawful activities into assets having a presumed lawful origin.

Law No. 25,246 (as amended, from time to time, specifically by Law No. 26,087, Law No. 26,119, Law No. 26,268, Law No. 26,683, Law No. 26,374, Law No. 27,446 and Law No. 27,440) provides for an administrative criminal system and replaces several sections of the Argentine Criminal Code, incorporating, among other matters, the definition of money laundering as a type of crime committed whenever a person converts, transfers, manages, sells, charges, conceals or otherwise markets any asset derived from a criminal offense, with the possible consequence that the original assets or substitutes thereof appear to come from a lawful source, provided that the total value of the asset exceeds Ps. 300,000 regardless of whether such amount results from one act or a series of related acts. Law No. 26,683 considers money laundering to be an autonomous crime against the economic and financial order, separate from the crime of concealment, which is an offense against the public administration, which allows for sanctions for the autonomous crime of money laundering regardless of participation in the crime that originated the funds subject to such money laundering. With the enactment of Law No. 27,260 and Decree No. 895/2016, the Financial Information Unit (*Unidad de Información Financiera* or “UIF”) was moved under the jurisdiction of the Ministry of Finance and Public Finance. Subsequently, in accordance with Decree No. 2/2017, the UIF acts under the jurisdiction of the Ministry of Finance.

According to Article 303 of the Argentine Criminal Code, money laundering (as defined above) shall be punished with three to ten years of imprisonment and a fine of two to ten times the amount of the transactions made. The penalty prescribed above shall be increased by one third of the maximum and one half of the minimum if: (a) the wrongdoer carries out the act on a regular basis or as a member of an association or gang organized with the purpose of continuously committing acts of a similar nature; or (b) if the primary wrongdoer is a public officer who committed the infringement in the exercise of his/her duties (in such a case, the wrongdoer shall also be punished by special disqualification for three to ten years, and the same penalty shall apply to a wrongdoer who commits the offense in the service of a profession or trade requiring special qualification). The individual who receives money or other assets derived from a criminal offense with the purpose of applying them to a money laundering transaction shall be punished with imprisonment from six months to three years. If the value of the assets is not over Ps. 300,000, the wrongdoer will be punished with imprisonment from six months to three years. The provisions in this section shall apply even when the criminal offense is committed outside the geographical jurisdiction of the Argentine Criminal Code, so long as the crime is also penalized in the jurisdiction where it was committed.

Article 277 of the Argentine Criminal Code sets forth that an imprisonment of between six months and three years shall be applied (with varying minimum terms attaching depending on the particular circumstances) to any person who helps a perpetrator avoid or be removed from prosecution, obscures or destroys evidence of a crime, acquires, receives, hides or alters money or other proceeds from a crime, does not report the commission of the crime or does not identify the perpetrator or participant in a crime with knowledge that such person would have been obliged to assist in the criminal prosecution of such crime and/or aids or abets the perpetrator or participant in making safe the proceeds of the crime. The minimum and maximum terms of punishment shall be doubled when: (a) the offense implies a particularly serious crime (for which minimum penalty is higher than three years of imprisonment); (b) the abettor acts for profit; (c) the abettor habitually commits concealment acts; or (d) the abettor is a public official.

At the end of 2011, with the enactment of Laws No. 26,733 and 26,734, new crimes were introduced into the Argentine Criminal Code to protect financial and stock market activities and to prevent the financing of terrorism. On the one hand, Law No. 26,733 established penalties of imprisonment, fines and special disqualification for anyone who: uses or supplies inside information to conduct securities transactions (Articles 307 and 308); manipulates stock markets by offering or conducting securities transactions through false information, feigned negotiations or meeting of the main shareholders in order to negotiate at a certain price (Article 309); and carry out financial and stock market activities without corresponding authorization (Article 310). On the other hand, Law No. 26,734 incorporated into the Argentine Criminal Code Article 306, which punishes with imprisonment and fines those who directly or indirectly collect assets or money to be used to finance a crime or an individual or organization that threatens the population, or to force national or foreign authorities or an international organization to perform or refrain from performing a particular act. The penalties will apply regardless of whether the crime was committed, or the financing was used. Additionally, the penalties will apply if the crime, individual or organization that is intended to be financed is carried out or located outside of Argentina. Likewise, the UIF was empowered to freeze assets linked to the financing of terrorism through a reasoned decision and immediate communication to a competent judge.

Law No. 25,246 contemplates that a legal entity whose management collected or provided assets or money, whatever their value, knowing that such assets were to be used by a terrorist organization, may be subject to a fine

between five and 20 times the value of such assets. Furthermore, whenever the management of the legal entity infringes the duty to treat the information submitted to the UIF as confidential, the legal entity shall be subject to a fine between Ps. 50,000 and Ps. 500,000. Additionally, such regulation created the UIF as an autonomous and financially self-sufficient entity within the jurisdiction of the Argentine Ministry of Finance, in charge of analyzing, treating and transmitting information in order to preclude and prevent money laundering. Pursuant to this legislation, the UIF is empowered to receive and request reports, documents, background and any other information deemed useful to fulfill its duties from any public entity, whether federal, provincial or municipal, and from individuals or public or private entities, all of which entities must furnish such information in accordance with Law No. 25,246. Whenever the information furnished, or analyses performed by the UIF show the existence of sufficient evidence to suspect that a money laundering or terrorist financing crime has been committed, the UIF shall transmit such evidence to the Government Attorney's Office so that it may start the relevant criminal action, and the UIF may appear as an accusing party to such proceedings. Moreover, Law No. 26,087 mandates that banking secrecy or professional privilege, or legal or contractual commitments, cannot be considered exceptions to the compliance with the obligation to submit information to the UIF in the context of an investigation of suspicious activity. The main goal of Law No. 25,246 is to prevent money laundering and the financing of terrorism. In line with internationally accepted practices, the duty to control such illegal transactions is not concentrated solely in Argentine federal governmental entities but is also distributed among several private sector entities such as banks, brokers, brokerage firms and insurance companies. One of the mechanisms of the regime of preventing and combating these crimes consists in the obligation to inform the UIF, set forth in Article 20 of the Prevention of Money Laundering Law, of those persons listed in such Article, which, due to their profession, activity or industry, hold a key position in the detection of suspicious money-laundering operations and/or terrorist financing transactions. Such duties mainly consist of data collection functions, such as: (i) gathering from clients, applicants or contributors any documentation sufficient to prove their identity, legal capacity, domicile and further data as necessary on a case by case basis; (ii) reporting any suspicious fact or transaction irrespective of its amount; and (iii) abstaining from disclosing to the client or third parties any procedures being followed pursuant to law. According to Law No. 25,246, a suspicious transaction shall mean any transaction that, in accordance with standard business practices and in the experience of the entities and individuals subject to reporting obligations, is regarded as unusual, unjustified from an economic or legal standpoint, or unnecessarily complex, whether it is a one-time transaction or a series of transactions.

In February 2016, the National Executive Office issued Decree No. 360/2016, through which it creates, under the jurisdiction of the Ministry of Justice and Human Rights, and directly dependent on its leadership, the "National Coordination Program in the Fight against Money Laundering and Terrorist Financing," with the mission of reorganizing, coordinating and strengthening the national anti-money laundering system and against the financing of terrorism, attending to the specific risks that could impact national terrorism and effective global exigencies in compliance with international obligations and recommendations established by the United Nations Conventions and the standards of the Financial Action Task Force ("FATF"). By virtue of Article 6 of Decree No. 360/2016, the UIF will act as the coordinator in the material operation of the national, provincial and municipal order in the strict compliance of its duties as a financial information organization.

Resolution No. 30-E/2017 of the UIF ("Resolution 30"), which became effective in its totality in June 2018, abrogated Resolution No. 121/2011 and set forth new obligations that financial entities subject to Law No. 21,526 and exchange entities subject to Law No. 18,924, as amended (the "Resolution 30 Reporting Parties"), must observe in their capacity as reporting parties pursuant to article 20, paragraphs 1 and 2, of Law No. 25,246. Resolution 30 follows the International Standards on Combating Money Laundering and the Financing of Terrorism and Proliferation issued by the FATF in 2012, with the purpose of adopting a risk-based approach to ensure that measures to prevent or mitigate money laundering and terrorist financing are commensurate with the risks identified.

Among other duties and obligations, Resolution 30 provided that Resolution 30 Reporting Parties must: (i) develop and document the risk identification and assessment methodology they will implement in order to identify, evaluate, mitigate and monitor their ML/TF (as defined below) risks, and (ii) have adjusted their policies and procedures, as set forth in Resolution 30, and in accordance with the results of the risk self-assessment performed (which policies should be incorporated into the Resolution 30 Reporting Party's money laundering and financing of terrorism ("ML/FT") Prevention Manual (as defined below).

Resolution No. 229/2011 of the UIF, as amended by UIF Resolutions No. 52/2012, 140/2012, 104/2016, 141/2016 and 4/2017 ("Resolution 229"), is applicable to brokers and brokerage firms, companies managing mutual

funds, over-the-counter market agents, and all intermediaries engaged in the purchase, lease or borrowing of securities trading in the field of stock exchanges with or without markets attached to them and intermediaries registered with futures and options markets, whichever their purpose may be (“Resolution 229 Reporting Parties”, and together with the Resolution 30 Reporting Parties, the “Reporting Parties”). Resolution 30 and Resolution 229 regulate, among other matters, (i) the obligation to collect certain documentation from clients, (ii) the obligations and internal restrictions to be implemented for purposes of complying with their duty to report suspicious ML/TF operations and (iii) know your customer (KYC) policies (including the distinction between regular and occasional clients), information which must be requested from clients, documentation storage requirements and the procedures for purposes of detecting and reporting suspicious transactions.

Pursuant to Resolution 30 and Resolution 229, the Reporting Parties’ main duties consist of: (i) implementing a manual (the “Prevention Manual”), based on the Reporting Party’s particular activities, setting forth the mechanisms and procedures to be used to prevent ML/TF; (ii) the designation of a compliance officer pursuant to article 20 bis of Law 25,246, as amended, and article 20 of Decree No. 290/07, as amended; (iii) the implementation of periodic audits; (iv) personnel training; (v) elaborating and maintaining analysis records and risk management of detected unusual operations and operations reported because they were considered suspicious; (vi) implementation of technological tools to have efficient control systems and be able to prevent money laundering and terrorism financing; and (vii) implementation of measures that allow the Reporting Parties, respectively, to electronically consolidate the operations they perform with clients, as well as technological tools, which enable analyzing or monitoring different variables to identify certain behaviors and detect possible suspicious operations. The Reporting Parties must report to the UIF any suspicious transaction within 30 calendar days from the day a transaction is qualified as a suspicious transaction on money laundering grounds (and regardless of whether the action was completed or attempted) and any suspicious transaction on terrorism financing grounds of within 48 hours of its occurrence.

Resolution 30 defines (i) “unusual transactions” as those which lack economic and/or legal justification, whether attempted or performed in isolation or repeatedly, regardless of their amount, do not correspond to the client’s risk or transactional profile, or that, due to their frequency, recurring nature, amount, complexity, nature and/or other particular characteristics, deviate from standard market practices, and (ii) “suspicious transactions” as those operations, whether attempted or performed, that cause a suspicion of ML/FT activities, or that have previously been identified as an unusual transaction, and after the analysis and evaluation carried out by the Reporting Party, cannot be justified. Resolution 229 defines (i) “unusual transactions” as those operations that are attempted or carried out in isolation or repeatedly, without economic and/or legal justification, and that do not relate to the risk or transactional profile of the client or deviate from standard market practices, due to their frequency, recurring nature, amount, complexity, nature and/or particular characteristics, and (ii) “suspicious transactions” as those operations that are attempted or carried out that cause a suspicion of ML/FT activities, or that have previously been identified as an “unusual transaction”, and after the analysis and evaluation carried out by the Reporting Party, they create a doubt about the authenticity, veracity or coherence of the documentation presented by the client, in relation to their activity. Pursuant to Resolution 30, financial entities have the duty to (i) implement an ML/FT prevention system, which must contain all the policies, procedures and controls established for ML/FT risk management to which they are exposed, and the elements of compliance required by such resolution and (ii) constitute an anti-ML/FT prevention committee.

Furthermore, Resolution 30 modified compliance officers’ duties and required entities to upload the following reports through the UIF website: (a) a report of cash transactions in excess of Ps. 200,000; (b) a report detailing international transfers from and to Argentine accounts; and (c) an annual systematic report.

Resolution No. 92/2016 of the UIF imposed on the reporting parties the obligation to implement a risk management system in accordance with the “voluntary and exceptional affidavit of holding of national currency, foreign currency and other assets in the country or abroad” established by Law No. 27,260, in order to report suspicious transactions performed by clients until March 31, 2017, derived from the tax amnesty regime.

In addition, the CNV Rules, under Title XI of “Prevention of Money Laundering and Terrorist Financing,” establish that brokers and brokerage firms, and companies managing common investment funds, agents of the over-the-counter market, intermediaries in the purchase or lease of securities affiliated with stock exchange entities with or without associated markets and intermediary agents registered on forwards or option markets, and individuals or legal entities acting as trustees, for any type of trust fund, and individuals or legal entities, owners of or related to, directly or indirectly, with trust accounts, trustees and grantors in the context of a trust agreement, shall comply with Law No.



25,246, the UIF's rulings and the CNV's regulations. Additionally, companies managing common investment funds, any person acting as placement agent or performing activities relating to the trading of common investment funds, any person acting as placement agent in any primary issuance of marketable securities, and any issuer with respect to capital contributions, irrevocable capital contributions for future issuances of stock or significant loans, must also comply with such regulations.

Such resolutions also contain certain requirements for the reception and delivery of checks and payments made between the individuals and entities listed above, as well as the prohibition of transactions relating to the public offering of securities, when they are consummated or ordered by individuals or companies domiciled or residing in domains, jurisdictions, territories or associated states not included in the list of Decree No. 589, as amended (regulating mainly the jurisdictions which are considered "cooperatives for fiscal transparency purposes").

Brokers and dealers must duly know their clients and apply policies and maintain adequate structures and systems in line with a policy against money laundering and terrorist financing. Also, interested investors undertake the obligation to submit any information and documents that may be required in order to comply with criminal regulations and other laws and regulation in connection with money laundering, including capital market regulations preventing money laundering issued by the UIF and similar regulations issued by the CNV.

According to the regulations related to the prevention of money laundering, the financing of terrorism and other illicit activities issued by the Central Bank, financial entities should take certain measures with respect to their clients, including, without limitation:

- observe the regulations governing the collection of proceeds, the legislation applicable to these matters (laws and regulatory decrees) and the regulations of the UIF. This includes the decrees of the National Executive Office with reference to the decisions adopted by the United Nations Security Council in combatting terrorism and the resolutions (and their respective annexes) issued by the Ministry of Foreign Affairs and Worship;
- in the absence of documentation or the existence of doubts and/or the detection of irregularities regarding veracity, accuracy, coherence or integrity of the documents provided by the clients, or because situations have been detected that deviate from the customer profile (as determined in accordance with existing regulations), require additional information and/or documentation, indicating to the client the obligation to comply with such additional requests;
- under no circumstance can relationships with new clients be carried out until the provisions of current regulations regarding the identification and knowledge of the client, and risk management are duly complied with;
- in the case of existing clients in respect of which identification and knowledge could not be complied with in accordance with the regulations in force, an analysis should be made with a risk-based approach, in order to assess the continuity of the relationship with the client. In this sense, in May 2019, Communication "A" 6,709 of the Central Bank (which amended and restated Communication "A" 6,060 of the Central Bank) sets forth that the criteria and procedures to be applied in this process must be described by the financial entities in their Prevention Manual. If it is appropriate to discontinue the relationship with a client, the procedures and deadlines established by the provisions of the Argentine Central Bank that are specific to the applicable product(s) must be observed. The reporting subjects must keep the written records of the procedures applied in each case where they discontinue the relationship with a client, for a period of 10 years;
- send a certified copy of the designation of the regular and alternate chief compliance officer, if any, to the UIF of the Central Bank, carried out in accordance with the conditions and within the terms established in the regulations issued by the UIF;
- keep a database with information corresponding to clients that perform individual operations for the amounts set forth by each financial institution according to the risk profile.

In addition, Central Bank Communication “A” 6,709 (which amended and restated Communication “A” 6,094) establishes that the regulations of the prevention of money laundering, terrorist financing and other illicit activities issued by the Central Bank must also be complied with by the foreign representatives of the financial entities that are not authorized to operate in Argentina.

Through the enactment of Law No. 27,260 and its related regulations and Decree No. 895/2016, the UIF was granted the power to communicate information to other public entities with intelligence or investigation powers, provided that such powers can only be exercised following a well-founded resolution issued by the UIF’s president and solely in those case where there are serious, precise and concordant signs regarding the commission of any of the crimes set forth by Law No. 25,246. Any information provided by the UIF will be transferred along with the obligation to maintain secrecy pursuant to Article 22 of Law No. 25,246, and any unlawful disclosure of confidential information by any entity will be subject to certain penalties. The UIF will not exercise the authority referred to in cases related to voluntary and exceptional declarations made under Law No. 27,260.

On June 18, 2018, by means of Law No. 27,446, modifications to numerous sections of the Anti-Money Laundering Law were introduced, with the purpose of simplifying and streamlining judicial proceedings, adapting the regulations in force to the operative reality of the UIF and to adopt certain international standards in the field of information exchange.

For a more exhaustive analysis of the anti-money laundering regime applicable as of the date of this offering memorandum, it is suggested that investors should consult with their legal advisors regarding the applicable regulations, such as Title XVIII, Book Two of the Argentine Criminal Code, and the regulations issued by the UIF, the CNV and the Central Bank regulations, which can be found on the website of the Ministry of Justice and Human Rights of Argentina, under the section “Legislative Information” ([www.infoleg.gov.ar](http://www.infoleg.gov.ar)), on the UIF’s website ([www.uif.gov.ar](http://www.uif.gov.ar)), on the CNV’s website ([www.cnv.gov.ar](http://www.cnv.gov.ar)) and/or the Central Bank’s website ([www.bcra.gov.ar](http://www.bcra.gov.ar)). None of the information on or connected to such websites is incorporated by reference into this offering memorandum.

#### **Law No. 27,401 on Corporate Criminal Liability**

On November 8, 2017, a law establishing the criminal liability regime applicable to private legal entities, state-owned or not, was enacted by the Argentine Congress and published in the Official Gazette of the Argentine Republic on December 1, 2017 (the “Corporate Criminal Liability Law”). The law entered into force in March 2018, 90 days following its publication.

The Corporate Criminal Liability Law applies to private legal entities for the crimes of national and transnational bribery and influence peddling, transactions that are incompatible with the exercise of public offices, and illegal exaction committed by public officials, among others.

Legal entities are liable for those crimes, carried out directly or indirectly, with their intervention or in their name, interest or benefit. The legal entity is also liable if a third party, without any capacity to act on its behalf, acted in its own benefit or interest, provided the legal entity has ratified the third party’s acts, even implicitly.

In the event of transformation, merger, absorption, spin-off or any other corporate restructuring, the legal entity’s responsibility will be transferred to the resulting or absorbing legal entity.

The law also provides that the legal entity may be convicted even if the individual involved could not be identified or judged, provided that the circumstances of the case allow establishing that the crime could not have been committed without the acquiescence of the legal entity’s bodies.

The penalties that could be applicable to legal entities include fines, total or partial suspension of business activities of up to ten years, suspension from participating in public bids or tenders for the execution of public works or services, dissolution and winding up of the legal entity under certain circumstances, loss or suspension of government benefits, among others.

Penalties can be graduated by judges, who will contemplate the compliance of internal rules and procedures, the number and hierarchy of the officials, employees and collaborators involved; the lack of surveillance; the extent of damage caused; the amount of money involved; the willingness to reduce or repair the damage and recidivism.

The legal entity will be exempted from penalties and administrative liability provided that: a) it has self-reported an offense under the Corporate Criminal Liability Law; b) it has implemented an adequate monitoring and supervision system (a “Compliance Program”), prior to the occurrence of the fact under prosecution, and c) it has returned the undue benefit obtained.

The Public Prosecutor’s Office (*Ministerio Público Fiscal*) and the legal entity may enter into an effective collaboration agreement, whereby the latter undertakes to cooperate by disclosing data or information for the clarification of the facts, the identification of the participants and/or the recovery of the assets or profits proceeding from the crime, as well as to comply with the other conditions established by the Corporate Criminal Liability Law.

Legal entities are not required under the Corporate Criminal Liability Law to implement Compliance Programs with the exception of those entering into certain agreements with the Argentine government. The Compliance Programs shall include a set of internal actions, mechanisms and procedures to promote integrity, supervision and control aimed at preventing, detecting and correcting irregularities and unlawful acts under this law.

## BUSINESS

### Business Overview

We are a leading Argentine power company, primarily engaged in the development and generation of electrical power from both conventional (thermal) and renewable (wind, solar and biomass) sources. As of the date of this offering memorandum, we have nine power plants with a total net installed capacity of 1,819 MW, including our 30.76% equity interest in the Central Dock Sud plant, which consists of Combined Cycle turbines with an installed capacity 797.5 MW and two Open Cycle turbines with an installed capacity of 36 MW each. Since July 2017, we have added through development or acquisition 723 MW to our power plants currently under operation.

We also have multiple projects under construction totaling 634 MW of installed capacity, including wind farms and thermal power plants, that are scheduled to commence operations in 2020, and substantially all of which have signed or been awarded PPAs.

We were formed in August 2013 as a result of a spin-off from Pluspetrol Energy S.A. and contribution of two of our power plants and certain other assets by YPF as our shareholder. YPF is Argentina's largest energy company with fully integrated oil and gas operations, maintaining leading market positions in both upstream and downstream segments, and is majority state-owned and has been listed on the Buenos Aires Stock Exchange and the New York Stock Exchange since 1993. Since our formation we have been focused on improving the operational efficiency and reliability of our power plants and developing new projects. Additionally, we strive to be a leading electricity generating company in the country and a leader in renewable energies, dedicated to maintaining high security, technology, efficiency and quality standards. As part of our strategy to continue to grow our business, in March 2018, an affiliate of General Electric subscribed for 24.99% of our capital stock, with the remaining percentage held by YPF. General Electric is a 126-year old diversified industrial company with operations in more than 180 countries and businesses spanning across the energy, aviation and healthcare sectors.

Our portfolio of operating and under-construction generation assets benefits from diversification of technology, offtakers and geographic locations within Argentina. Our thermal power plants and thermal projects include Combined Cycle turbines, Open Cycle turbines, co-generation turbines and motor-generators. Our renewable projects under construction consist of wind farms and our development pipeline includes solar photovoltaic and biomass projects. Our operating power plants and wind farms, together with our projects under construction have as offtakers not only CAMMESA (the entity that manages the administrative and technical energy supply and demand of SADI) but also YPF and other large private users, which we expect to become an increasingly important part of our client portfolio. In 2018, Energía Base revenues represented 45.9% of our revenue, while revenue under our PPAs with CAMMESA represented 36.7% and revenue under PPAs with other large users, private clients, steam sales, and others represented 17.5%.

During the three-month period ended March 31, 2019, we had revenues of Ps. 2,691.7 million net profit of Ps. 1,117.3 million and Adjusted EBITDA of Ps. 2,251.3 million, with an Adjusted EBITDA margin of 83.64%. During the year ended December 31, 2018, we had revenues of Ps. 7,124.9 million, net profit of Ps. 4,505.4 million and Adjusted EBITDA of Ps.7,530.3 million with an Adjusted EBITDA margin of 105.08%. For a reconciliation of Adjusted EBITDA to net profit, see "Selected Financial Data—Non-IFRS Financial Data."

We currently have eight thermal plants and one wind farm in operation, including our equity interest in the Central Dock Sud plant. The following table presents a brief description of our operating power plants and wind farm.

<b>Plant</b>	<b>Location</b>	<b>Installed capacity (MW)</b>	<b>Regulatory Framework / Offtaker</b>	<b>Technology</b>	<b>COD</b>	<b>Expiration date of PPA</b>
Tucumán Power Plant <sup>(1)</sup> .....	Province of Tucumán	447	Energía Base <sup>(6)</sup>	Combined Cycle	1996/1997	N/A
San Miguel de Tucumán Power Plant <sup>(1)</sup> .....	Province of Tucumán	382	Energía Base <sup>(6)</sup>	Combined Cycle	1995/2000	N/A

<b>Plant</b>	<b>Location</b>	<b>Installed capacity (MW)</b>	<b>Regulatory Framework / Offtaker</b>	<b>Technology</b>	<b>COD</b>	<b>Expiration date of PPA</b>
El Bracho GT <sup>(1)(2)</sup> .....	Province of Tucumán	267	PPA with CAMMESA <sup>(7)</sup>	Open Cycle	January 2018	January 26, 2028
Loma Campana I.....	Province of Neuquén	105	YPF <sup>(8)</sup>	Open Cycle	November 2017	November 14, 2032
Loma Campana II.....	Province of Neuquén	107	PPA with CAMMESA <sup>(7)</sup>	Open Cycle	November 2017	November 29, 2027
Loma Campana Este <sup>(3)</sup> .....	Province of Neuquén	17	YPF <sup>(8)</sup>	Motor generator	July 2017	July 11, 2020
LPC I <sup>(4)</sup> .....	Province of Buenos Aires	128	Energía Base <sup>(6)</sup>	Cogeneration	1997	N/A
Manantiales Behr.....	Province of Chubut	99	PPA with YPF and other industrial clients <sup>(9)</sup>	Wind farm	July/December 2018	Several PPAs <sup>(9)</sup>
Central Dock Sud.....	Province of Buenos Aires	267 <sup>(5)</sup>	Energía Base <sup>(6)</sup>	Combined Cycle/ Open Cycle	1989/2000	N/A
<b>Total.....</b>		<b>1,819</b>				

(1) Part of the “Tucumán Complex.”

(2) El Bracho ST Combined Cycle is under construction and is expected to start commercial operations in fourth quarter 2020. For reasons beyond our control, we may not commence commercial operations as required under the applicable PPA. See “Business–Our Projects–Thermal Energy–El Bracho ST”.

(3) Not connected to the SADI.

(4) Acquired from Central Puerto S.A. in February 2018, effective as of January 5, 2018. The LPC I power plant also produces between 190 and 210 tons of steam per hour, which are sold to YPF.

(5) Represents our 30.76% indirect equity interest in CDS, a power plant located in the Province of Buenos Aires and operated by Enel S.A., with an installed capacity of 797.5 MW of Combined Cycle turbines and 72 MW of installed capacity for two Open Cycle turbines (36 MW each).

(6) Resolution No. 1/2019.

(7) Resolution No. 21/2016.

(8) Self-generation.

(9) The generation under this wind farm is committed under nine PPAs with the private sector. The terms of such PPAs are from 5 to 21 years with a weighted average term of 11.5 years.

We have developed a significant pipeline of new energy projects with a team that has expertise in the entire cycle of electrical power generation, from prospecting and developing projects to constructing, operating and marketing power plants for both conventional and renewable generation. We are currently in the process of constructing three wind farms, two of which are located in the Province of Buenos Aires and one of which is located in the Province of Santa Cruz. We are also in the process of converting the El Bracho GT power plant into a Combined Cycle power plant with high power and efficiency combustion motors technology and we are constructing a cogeneration plant in the Province of Buenos Aires for industrial processes. The following table presents a brief description of our projects under construction, which requires an estimated total investment of approximately US\$915 million.

<b>Plant</b>	<b>Location</b>	<b>Additional Installed Capacity (MW)</b>	<b>Offtaker</b>	<b>Technology</b>	<b>Expected COD</b>	<b>Estimated Total Capital Expenditures</b>
Los Teros I.....	Province of Buenos Aires	123	MATER	Wind farm	1st quarter 2020	US\$165.5 million
LPC II.....	Province of Buenos Aires	85	CAMMESA	Cogeneration	2nd quarter 2020	US\$166 million
Cañadón León.....	Province of Santa Cruz	120	CAMMESA	Wind farm	3rd quarter 2020	US\$165 million

<b>Plant</b>	<b>Location</b>	<b>Additional Installed Capacity (MW)</b>	<b>Offtaker</b>	<b>Technology</b>	<b>Expected COD</b>	<b>Estimated Total Capital Expenditures</b>
El Bracho ST <sup>(1)</sup> .....	Province of Tucumán	198	CAMMESA	Steam Turbine	4 <sup>th</sup> quarter 2020	US\$290 million
Manantiales Behr Thermal Plant .....	Province of Chubut	58	YPF	Motor generator	4th quarter 2020	US\$63.2 million
Los Teros II .....	Province of Buenos Aires	50	MATER	Wind farm	4th quarter 2020	US\$65 million
<b>Total</b> .....		<b>634</b>				<b>US\$914.7 million</b>

(1) Closing cycle of our El Bracho GT power plant will increase its installed power capacity by 198 MW. For reasons beyond our control, we may not commence commercial operations before August, 2019 as required under the applicable PPA. See “Business—Our Projects—Thermal Energy—El Bracho ST”.

Our operating power plants, wind farm and projects under construction are located in the provinces of Tucumán, in the northern region of Argentina, Neuquén, in the southern region of Argentina, Buenos Aires, in the center of the country, and Chubut and Santa Cruz, in the southern region of Argentina, which ensures us proximity to users and access to multiple nodes of the SADI.

During the year ended December 31, 2018, our revenues under our PPAs and Energía Base accounted for 48.4% and 45.9% of our revenues, respectively, and during the three-month period ended March 31, 2019, our power sales under our PPAs and Energía Base accounted for 60.5% and 34.4% of our revenues, respectively, with the remaining percentage coming mainly from our steam sales and other services. We expect that, once we complete our projects under construction (expected by the fourth quarter of 2020), our revenues from PPAs and Energía Base will represent approximately 80% and 20% of our revenue, respectively.

We have entered into long-term PPAs with CAMMESA for El Bracho GT and Loma Campana II power plants and with YPF for Loma Campana Este and Loma Campana I power plants. Furthermore, as of the date of this offering memorandum, the weighted average remaining life of our PPAs for all of our operating thermal power plants is approximately 13 years. In relation to our projects under construction, we have entered into PPAs with CAMMESA for LPC II, El Bracho ST and Cañadón León and with YPF for the Manantiales Behr motor project. In addition, we have commenced entering into PPAs with other private large users in the MATER, which we believe are some of the most creditworthy groups in Argentina. The weighted average remaining life of our PPAs, including the PPAs for our projects under construction, is approximately 16 years (for our wind farms, based on the expected P50 load factor).

Our Tucumán, San Miguel de Tucumán, LPC I and Central Dock Sud power plants are dispatched under Energía Base. Energía Base applies typically to older plants in Argentina with compensation depending primarily on the availability of the plants adjusted based on the electricity dispatched. Tariffs under Energía Base are paid by CAMMESA and adjusted by resolution of the Secretary of Energy. From February 2017 to March 2019, Energía Base was regulated by Resolution No. 19/17, which significantly increased tariffs and denominated them in U.S. dollars. Resolution No. 19/17 was replaced by Resolution No. 1/2019, which maintained the tariffs denominated in U.S. dollars but adjusted the fixed remuneration of availability based on the electricity effectively dispatched by the relevant unit. Under Energía Base, the fuel required to produce the energy we generate is currently supplied by CAMMESA free of charge, and the price we receive as generators is determined without accounting for the natural gas or fuel CAMMESA supplies.

We also produce steam in our LPC I power plant, which we acquired in February 2018, effective as of January 5, 2018, and has an installed capacity of between 190 and 210 tons of steam per hour. We sell the steam to YPF under a 15-year steam supply agreement, which we entered into in January 2018. Our revenues from steam sales for the three-month period ended March 31, 2019 and the year ended December 31, 2018 were Ps. 136.3 million and Ps. 386.5 million, respectively (434,417 metric tons and 1,621,868 metric tons, respectively), which represented 5.1% and 5.4%, respectively, of our revenues for such period.

Our power generation plants are reliable and efficient for Argentina’s energy sector. Our Loma Campana I, Loma Campana II and Loma Campana Este power plants, located in the area of unconventional hydrocarbons

exploitation known as “Vaca Muerta” in the Province of Neuquén, began commercial operations on November 15, 2017, November 30, 2017 and July 13, 2017, respectively, and have an installed capacity of 105 MW, 107 MW and 17 MW, respectively. In Loma Campana I and Loma Campana II we operate General Electric Open Cycle aeroderivative gas turbines, model LMS-100, one of the most efficient gas technologies available in the market, that are connected to the SADI, while in Loma Campana Este, located within YPF’s premises in Neuquén, we operate Jenbacher gas motor generators, model J-420, that are not connected to the SADI since we provide the energy they produce, as self-generator, directly to YPF. For the year ended December 31, 2018, the availability factor was 59%, 86% and 99.6%, respectively.

Our El Bracho GT power plant has one gas turbine provided by General Electric with an installed capacity of 267 MW. This plant reached commercial operation on January 27, 2018 and achieved an availability factor of 97% for the year ended December 31, 2018. El Bracho GT is located in the Province of Tucumán and is part of our Tucumán Complex that encompasses our Tucumán and San Miguel de Tucumán power plants. Our Tucumán Power Plant is a Combined Cycle plant with two Siemens gas turbines, a General Electric steam turbine and two Nooter Eriksen’s HRSGs with a total installed capacity of 447 MW. Our San Miguel de Tucumán Power Plant is also a Combined Cycle power plant with two General Electric gas turbines, an Alstom steam turbine and two CMI HRSGs steam turbines with a combined installed capacity of 382 MW. Our Tucumán and San Miguel de Tucumán power plants had an availability factor of 99% and 97%, respectively, during the year ended December 31, 2018. In February 2018, effective as of January 5, 2018, we acquired LPC I, a power plant located in the Province of Buenos Aires and within YPF’s refinery. The plant has an installed capacity of 128 MW and produces from 190 to 210 tons of steam per hour.

We own a 30.76% indirect equity interest in CDS, a power plant located in the Province of Buenos Aires with an installed capacity of 797.5 MW of Combined Cycle turbines and 72 MW of installed capacity for two Open Cycle turbines (36 MW each). The plant is operated by Enel S.A.

## **History and development**

We were formed in August 2013 as a result of the spin-off from PlusPetrol Energy S.A. and the contribution of certain generation assets, mainly Tucumán and San Miguel de Tucumán power plants, together with certain legacy oil and gas operations in the Ramos Area. Our date of incorporation is August 26, 2013 and our bylaws provide for a term of incorporation of 99 years. Our registration number is 16440, Book 65, Volume – of corporations. The generation assets contributed to us as part of the spin-off were valued at US\$112 million and, as part of this transaction, we assumed PlusPetrol Energy S.A.’s financial and working capital liabilities which, at the time of the spin-off, amounted to Ps. 105 million. Such liabilities were settled in full by mid-2014. Our first objectives as a newly formed company was to improve the level of efficiency of our operating assets and increase the availability of the operating plants by investing in maintenance of our equipment, engaging new suppliers and developing adequate human resources.

In 2015, as a result of the resurgence of unconventional hydrocarbon exploitation in the Vaca Muerta formation, we identified a market opportunity for a more reliable backup energy source in the Loma Campana reservoir in the Province of Neuquén and, in response, we designed and developed our first new generation project, the Loma Campana I power plant, which began commercial operations in November 2017.

The next step in our expansion was driven by the enactment of the Renewable Energy Law in 2015, which required large private users of electricity to purchase energy from renewable sources, and the need for YPF, the largest consumer of electricity in Argentina, to meet such standard. Previously, in 2013, foreseeing the growth of the renewable energy sector in Argentina, we installed three wind measuring towers in Manantiales Behr (Province of Chubut), Cañadón León (Province of Santa Cruz) and Sierra Barrosa (Province of Neuquén), aiming to develop three wind projects in the future with our own measurements. As a consequence, we decided to start the construction of Manantiales Behr, our first wind farm project, whose first phase of 49.5 MW began commercial operations in July 2018 and whose remaining 49.5 MW began commercial operations in December 2018.

In addition, in 2015, we participated in several bidding processes for distributed power generation services for industries or isolated areas required by YPF for its upstream operations at the Loma Campana reservoir in the Province of Neuquén and we were awarded PPAs with YPF for the sale of thermal power, which gave rise to our

Loma Campana Este power plant. This 16 MW plant provides energy directly to YPF and began commercial operations in July 2017.

In early 2016, we submitted a joint bid with General Electric for new thermal generation capacity under Resolution No. 21/2016. We were awarded two projects: (i) a 107 MW installed capacity Open Cycle thermal plant and (ii) a 267 MW installed capacity Open Cycle thermal plant. This gave rise to our Loma Campana II and El Bracho GT power plants which began commercial operations in November 2017 and January 2018, respectively.

The next step in our growth was driven by Resolution SEE No. 287/2017, which called for bids for newly installed capacity from Combined Cycle or cogeneration plants. We were awarded a project to build a new 85 MW cogeneration plant at YPF's refinery in La Plata and a new 198 MW project to convert our existing El Bracho GT Open Cycle plant into a Combined Cycle plant. This gave rise to our LPC II power plant and El Bracho ST closed cycle plant, which we expect to begin commercial operations in the second quarter and fourth quarter of 2020, respectively. For reasons beyond our control, we may not commence commercial operations in El Bracho ST as required under the applicable PPA. See "Business—Our Projects—Thermal Energy—El Bracho ST".

We also participated in the bidding process for renewable energy known as "RenovAr 2.0," under which we were awarded a PPA for 99 MW of our Cañadón León wind project, which is expected to have a total capacity of 120 MW (the remaining parts are expected to be sold through private PPAs) and which we expect to begin commercial operations in the third quarter of 2020.

As part of our plans to concentrate in electricity generation assets, in May 2017, YPF contributed (i) a 42.86% equity interest in Inversora Dock Sud, which has a 71.78% equity interest in CDS, and a (ii) 9.64% equity interest in CDS. CDS owns the 797.5 MW Central Dock Sud Combined Cycle plant and a 72 MW of Open Cycle turbines, which are operated by Enel S.A. The 9.64% equity interest in CDS was subsequently sold for US\$14 million. In addition, on February 2, 2018, we sold our 27.00% equity interest in the Ramos Area to YPF.

As part of our expansion plans and to support our continuing growth, in February 2018, effective as of January 5, 2018, we purchased our LPC I power plant from Central Puerto S.A., which has an installed capacity of 128 MW. Such power plant operates under Energía Base and supplies steam to YPF.

Lastly, with our strong portfolio of new projects and in the interest of continuing to develop our strategy, in 2017 we entered into negotiations to incorporate a strategic partner that would support us with our rapid expansion. On February 6, 2018, we entered into a subscription agreement with GE EFS by which GE EFS agreed to subscribe to our newly issued shares representing 24.99% of our share capital in exchange for US\$275 million payable in two installments (on closing and on the first anniversary of closing) and, upon the occurrence of certain conditions, subscribe additional shares for an amount representing 0.01% of our share capital in exchange for a contingent payment of up to US\$35 million. This transaction closed on March 20, 2018. In addition, on March 20, 2018, we acquired a 33.33% equity interest in Y-GEN and Y-GEN II from General Electric. Y-GEN and Y-GEN II were the two special purpose vehicles that we used together with General Electric to develop and operate the Loma Campana II and El Bracho ST projects.

On May 10, 2018, as part of our strategy to develop renewable energy assets, we acquired 100% of the shares of Luz del Cerro S.A., a company whose single asset is the development of the wind farm project known as Los Teros I located in the town of Azul, Province of Buenos Aires, with a 123 MW installed capacity. The purchase price of the shares amounted to Ps. 98.5 million. In addition, on November 21, 2018, the Company acquired 100% of the shares of Luz del Valle S.A., a company whose single asset is the development of the wind farm project known as Los Teros II also located in the town of Azul, Province of Buenos Aires. This wind farm will have a 49.8MW capacity. The purchase price of the shares amounted to Ps. 44.9 million.

The following chart summarizes the key milestones in our history.



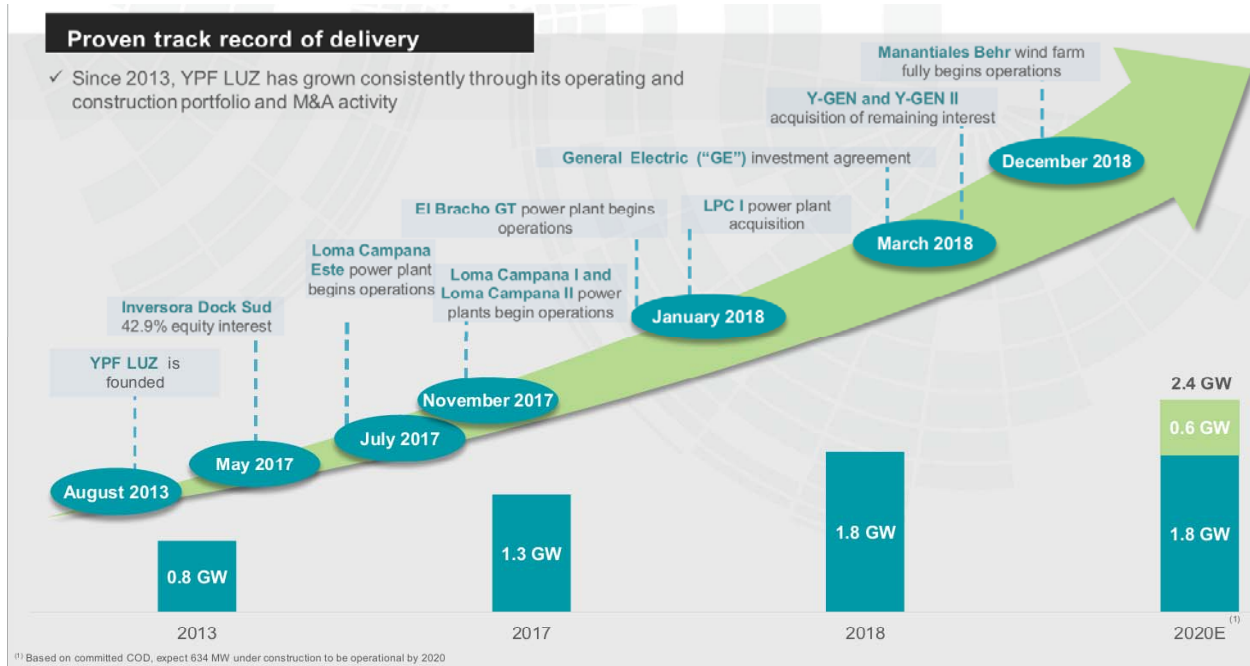

## Corporate Structure

The following chart summarizes our corporate structure as of the date of this offering memorandum:

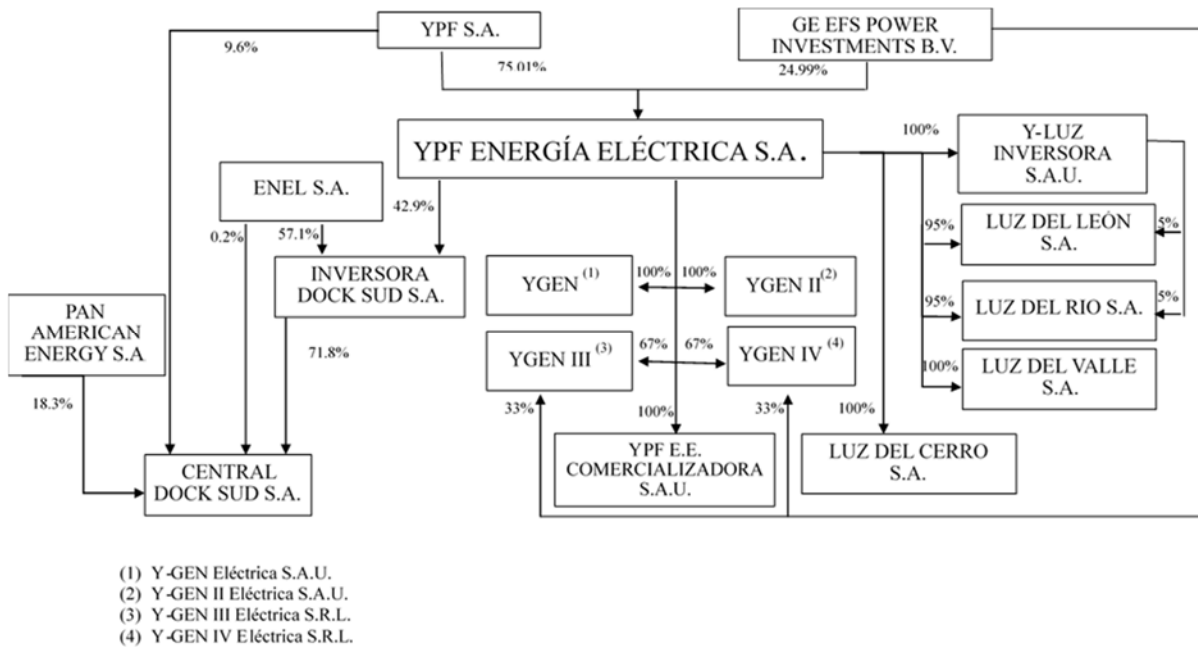

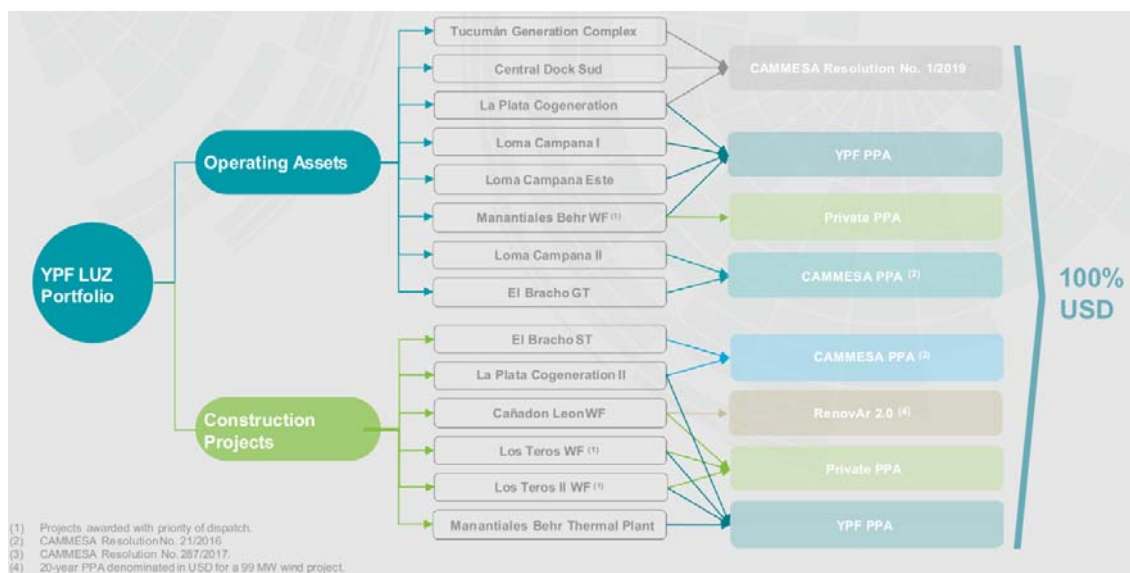
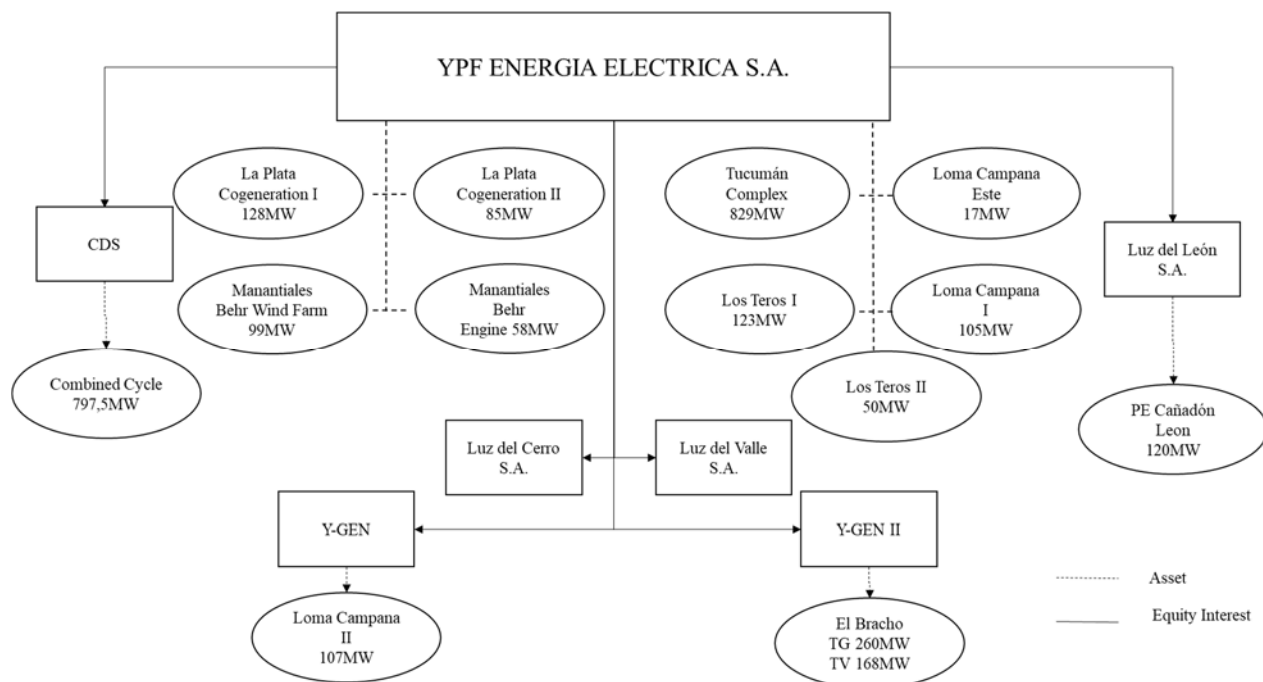

### Central Dock Sud

We indirectly hold a 30.76% equity interest in CDS, which owns the Central Dock Sud plant and has a 1.4% interest in Termoeléctrica José de San Martín S.A. and a 1.3% interest in Termoeléctrica Manuel Belgrano S.A. Termoeléctrica José de San Martín S.A. and Termoeléctrica Manuel Belgrano S.A. are private, unlisted companies, which are engaged in managing the purchase of equipment, and building, operating and maintaining the San Martín and Belgrano power plants, respectively, each constructed under the FONINVEMEM program. For the year ended December 31, 2018, and for the three-month period ended March 31, 2019, CDS accounted for 5.9% and 11.7%, respectively, of our net profit.

## Our Strengths

**Reliable high-quality generation assets which are technologically and geographically diverse.** We have eight high-quality operating thermal plants, a wind farm which ranks among the best of its type in terms of generation records, and three thermal projects under construction in which we will operate Combined Cycle turbines, co-generation turbines and motor-generators. We also have three wind farm projects under construction, Los Teros I and Los Teros II, both in the Province of Buenos Aires, and Cañadón León in the Province of Santa Cruz. Also, our development pipeline includes solar power, biomass, and thermal motor generators and Combined Cycle projects, among others. Our thermal operating plants have relatively high efficiency levels due to the use of modern technologies combined with regular maintenance conducted by our highly trained employees and prime technology and maintenance suppliers, such as General Electric. Our thermal power plants had a weighted average availability factor of 91% during the year ended December 31, 2018. Moreover, our wind farms under construction are located in areas with very favorable wind conditions and they each have an expected load factor in excess of 50%. Our operating plants and projects under construction are located in the northern, central and southern regions of Argentina, gives us flexibility to dispatch energy into SADI at different interconnection points and protects our portfolio from transmission restrictions in the SADI derived from system failures and the installation of new capacity.

**New projects to support growth and increase profitability.** Our successful track record in recent auctions held by the Argentine government, industrial clients and YPF, together with the timely construction and commencement of operations of our new operating power plants and wind farm, our operating efficiency and safety have proven our ability to source, win and develop new projects at competitive energy prices, meet construction deadlines, and operate and maintain our power plants in accordance with industry standards. Over the past three years, we have been awarded over 13% of the total MW of installed capacity awarded by CAMMESA through long-term PPAs. We currently have 634 MW of capacity under construction consisting of 341 MW of thermal power and 293 MW of renewable energy, which are expected to begin commercial operation in mid 2020. In addition, we have a pipeline of additional projects that we expect to commit in future tenders or offer to large private users that seek to supply their energy needs from renewables.

**Renowned local and international sponsors.** YPF and General Electric are, directly or indirectly, beneficial owners of 75.01% and 24.99% of our capital stock, respectively. YPF is Argentina's largest energy company operating a fully integrated oil and gas chain, with leading market positions in both upstream and downstream segments, and is majority state-owned and listed on the Buenos Aires Stock Exchange and in the New York Stock Exchange since 1993. YPF is also one of the largest users of electricity in Argentina and is the country's largest private offtaker, with PPAs for more than 180 MW of installed capacity. General Electric is a 126-year old diversified industrial company with operations in more than 180 countries and businesses spanning across the aviation, energy and healthcare sectors. Our shareholders provide significant support for our plants and expansion plans, providing technology and technical support needed to pursue our objectives.

**Strong and growing cash flow generation, supported by U.S. dollar denominated cash flows.** Our revenues mainly derive from long-term U.S. dollar-denominated PPAs and Energía Base. Revenues from our newest power plants are derived from U.S. dollar denominated PPAs with CAMMESA and YPF, with terms ranging from 10 to 20 years (except for the agreement for Loma Campana Este which has a term of three years). Our existing PPAs for our thermal power plants provide for payments for available capacity and for electricity effectively generated and dispatched. On the other hand, our Manantiales Behr wind farm has U.S. dollar denominated long-term PPAs for 100% of its generation capacity with YPF and other different industrial clients. In addition, since February 2017, the remuneration under Energía Base is denominated in U.S. dollars, which encompasses nearly 67% of our installed capacity as of March 31, 2019. We also have three thermal plants and three wind farms under construction, whose revenues will mainly derive from U.S. dollar denominated PPAs that we have signed. The revenues from the renewable energy projects' PPAs, which have an expected load factor greater than 50%, will derive from the amount of energy dispatched since such projects benefit from dispatch priority granted by CAMMESA. By the end of 2020, we expect that approximately 39% and 41% of our revenue will derive from PPAs with private offtakers (including YPF) and CAMMESA, respectively, and the remaining 20% from Energía Base.

**Strong management team and high-quality workforce.** Our management team has extensive industry and financial experience, including over 20 years of experience in the Argentine energy sector. We believe that our management team has been successful in identifying attractive investment opportunities, structuring innovative

business plans and completing complex transactions efficiently, as demonstrated by our considerable expansion since our inception in 2013 (from 829 MW of installed capacity at our inception in 2013 to 1,819 MW as of the date of this offering memorandum) as well as the amount and diversity of our projects currently under construction (634 MW of projects under construction as of the date of this offering memorandum). We also believe that our workforce has the experience, knowledge and training adequate to operate and maintain our operating assets while improving our efficiency levels. This combination of experienced management and a highly skilled technical and operative workforce contributes to our ability to efficiently operate our assets, identify and evaluate high-quality growth opportunities and integrate new businesses that are acquired or developed, and, therefore, make our company efficient and profitable.

## **Our Strategy**

Our mission is to be a profitable, efficient and sustainable power company, focused on optimizing natural resources and contributing to the development of the energy industry in Argentina and the markets in which we operate. Our vision is to be one of the major companies in the country's electricity generation sector, a leader in renewable energies with worldwide safety, technology, efficiency and quality standards.

Despite having a track record of only almost six years in the power generation market, we have generated a results-oriented culture based on the values of commitment, sustainability, passion, team work and agility, and we have managed to become one of the major players in the Argentine power generation sector. We are strongly committed to addressing Argentina's expected growth in demand in the long term and to the creation of value for our shareholders and other stakeholders. We plan to continue to invest in growing our generation asset portfolio in a balanced, diversified and integrated manner by taking advantage of available opportunities that provide competitive returns.

Our 2019-2023 strategic plan is based on significantly increasing our installed capacity of efficient thermal and renewable generation both through new developments and opportunistic acquisitions.

We have established the following strategic guidelines to carry out our plan:

- sustainable growth with profitability and financial discipline;
- seek leadership in the generation market with a focus on renewable energies;
- provide competitive energy solutions for our customers;
- operations and processes that are efficient, reliable, transparent, complete and safe;
- develop and strengthen our management and employees as a differentiating element; and
- social and environmental sustainability in our operations.

Objectives are grouped into four categories, as follows:

### *Financial:*

- grow in a sustainable way with profitability and generation of value; and
- maintain financial solvency to allow for growth opportunities.

### *Marketing:*

- increase market share with leadership in renewables;
- develop our portfolio of clients with private PPAs;

- be the sole energy supplier of YPF; and
- develop other business opportunities to ensure sustainability.

*Internal processes:*

- achieve competitive costs while seeking efficiency in operations;
- establish effective communication with all interested parties;
- manage efficiently and in compliance with applicable regulations, policies and processes; and
- achieve excellence in social and environmental sustainability of our operations.

*Human resources:*

- assemble a solid and well consolidated team;
- maintain a high level of technical knowledge and professionalism;
- strengthen leadership; and
- be proud of being part of the team.

## Our Energy Generation Assets

We own and operate seven thermal power plants as of the date of this offering memorandum including our equity interest in CDS. We also have three thermal projects under construction and three wind projects under construction. The following table shows key information about our power plants in operation and thermal and wind projects:

<b>Power Plants</b>	<b>Location</b>	<b>Installed capacity (MW)</b>	<b>Technology</b>	<b>COD / Expected COD</b>
<i>Operating</i>				
Tucumán Power Plant <sup>(1)</sup> .....	Province of Tucumán	447 MW	Combined cycle	1996/1997
San Miguel de Tucumán Power Plant <sup>(1)</sup> ..	Province of Tucumán	382 MW	Combined cycle	1995/2000
El Bracho GT <sup>(1)</sup> .....	Province of Tucumán	267 MW	Open Cycle	January 2018
Loma Campana I .....	Province of Neuquén	105 MW	Open Cycle	November 2017
Loma Campana II .....	Province of Neuquén	107 MW	Open Cycle	November 2017
Loma Campana Este <sup>(2)</sup> .....	Province of Neuquén	17 MW	Motor generator	July 2017
LPC I <sup>(3)</sup> .....	Province of Buenos Aires	128 MW	Cogeneration	1997
Central Dock Sud .....	Province of Buenos Aires	267 MW <sup>(4)</sup>	Combined cycle / Open Cycle	1989 / 2000
Manantiales Behr Wind Farm .....	Province of Chubut	99 MW	Wind	July 2018 / December 2018
<i>Projects</i>				
El Bracho ST <sup>(1)(5)</sup> .....	Province of Tucumán	198 MW	Closed cycle	4 <sup>th</sup> quarter 2020
LPC II .....	Province of Buenos Aires	85 MW	Cogeneration	2 <sup>nd</sup> quarter 2020
Cañadón León .....	Province of Santa Cruz	120 MW	Wind	3 <sup>rd</sup> quarter 2020
Los Teros I .....	Province of Buenos Aires	123 MW	Wind	1 <sup>st</sup> quarter 2020
Los Teros II .....	Province of Buenos Aires	50 MW	Wind	4 <sup>th</sup> quarter 2020
Manantiales Behr .....	Province of Chubut	58 MW	Motor generator	4 <sup>th</sup> quarter 2020

- (1) Part of the “Tucumán Complex.”
- (2) Not connected to the SADI.
- (3) Acquired from Central Puerto S.A. in February 2018, effective as of January 5, 2018. The LPC I power plant also produces 190-210 tons of steam per hour which are sold to YPF.
- (4) Represents our 30.76% indirect equity interest in CDS, a power plant located in the Province of Buenos Aires and operated by Enel S.A., with an installed capacity of 797.5 MW of Combined Cycle turbines and 72 MW of installed capacity for two Open Cycle turbines (36 MW each).
- (5) Conversion of our existing El Bracho GT power plant from an Open Cycle into a Combined Cycle plant, increasing its installed capacity by 198 MW. For circumstances beyond our control, we may not complete this project as required under the applicable PPA. See “Business—Our Projects—Thermal Energy—El Bracho ST”.

The map below shows the geographic locations of our power generation assets in operation and under construction as of the date of this offering memorandum.

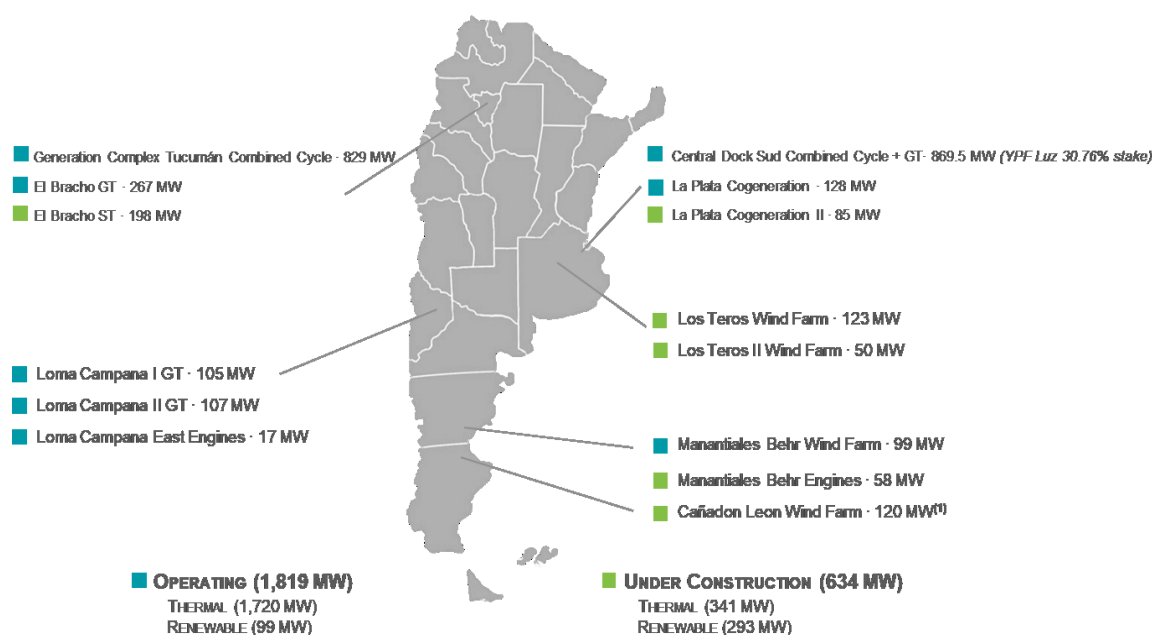

The table below provides the availability factor and net generation of our power plants in operation for the three-month period ended March 31, 2019 and the years ended December 31, 2018 and 2017.

	<b>Three-month period</b>		
	<b>ended March 31,</b>	<b>Year ended December 31,</b>	
	<b>2019</b>	<b>2018</b>	<b>2017</b>
<b>Tucumán</b>			
Availability Factor .....	101%	99%	87%
Net Generation (GWh).....	522	3,024.0	2,796.1
<b>San Miguel de Tucumán</b>			
Availability Factor .....	101%	97%	89%
Net Generation (GWh).....	280	2,208.1	2,500.8
<b>El Bracho GT<sup>(1)</sup></b>			
Availability Factor .....	98%	97%	
Net Generation (GWh).....	242	542.8	
<b>Loma Campana I<sup>(2)</sup></b>			
Availability Factor .....	94%	59%	32%
Net Generation (GWh).....	183	432.4	48.8
<b>Loma Campana II<sup>(3)</sup></b>			
Availability Factor .....	100%	86%	56%
Net Generation (GWh).....	143	395.5	65.0

	Three-month period ended March 31,	Year ended December 31,	
	2019	2018	2017
<b>Loma Campana Este<sup>(4)</sup></b>			
Availability Factor .....	100%	97%	98%
Net Generation (GWh).....	9.6	33.5	8.9
<b>LPC I<sup>(5)</sup></b>			
Availability Factor .....	95%	96%	-
Net Generation (GWh).....	215	873.4	-
<b>Manantiales Behr<sup>(6)</sup></b>			
Availability Factor .....	100%	96%	-
Net Generation (GWh).....	124	144.5	-
<b>Central Dock Sud<sup>(7)</sup></b>			
Availability Factor .....	83%	71%	87%
Net Generation (GWh).....	1066	3,494.8	4,944.3

(1) Began commercial operation on January 27, 2018.

(2) Began commercial operation on November 15, 2017.

(3) Began commercial operation on November 30, 2017.

(4) Began commercial operation on July 13, 2017.

(5) We acquired the LPC I power plant from Central Puerto S.A. in February 2018, effective as of January 5, 2018.

(6) Began partial commercial operation on July 25, 2018 and full commercial operation on December 22, 2018.

(7) We own a 30.76% indirect equity interest in CDS, a power plant located in the Province of Buenos Aires and operated by Enel S.A., with an installed capacity of 797.5 MW of Combined Cycle turbines and 72 MW of installed capacity for two Open Cycle turbines (36 MW each).

## Our Power Plants

### Our Operating Thermal Power Plants

We own the following thermal power plants in the Province of Tucumán, which jointly conform the “Tucumán Complex”: (i) Tucumán Power Plant, (ii) San Miguel de Tucumán Power Plant and (iii) El Bracho, which has an operating gas turbine (El Bracho GT) and a steam turbine under construction (El Bracho ST).

#### Tucumán Plant

The Tucumán plant is a Combined Cycle plant located in El Bracho, approximately 22 km south of San Miguel de Tucumán, Province of Tucumán. It has an installed capacity of 447 MW and is comprised of two Siemens V94.2 gas turbines (GT), a dual-pressure GE Series D steam turbine without reheat (ST), and two Nooter Eriksen HRSG. The Combined Cycle unit heat rate is approximately 7.355kJ /MWh, with an efficiency ratio of 49%. This plant is fueled with natural gas which, pursuant to Resolution No. 1/2019, is supplied by CAMMESA and distributed by GasNor. The Tucumán plant is connected to the SADI at 500 kV and 132 kV.

The plant water cooling system consists of an air-cooled condenser (33%) and a 4-cell draft cooling tower (66%). The first gas turbine became operational in 1996 and the second one in 1997. The Combined Cycle commenced operations in 1999. The Tucumán plant is capable of starting up without voltage (black start).

The Tucumán plant is wholly-owned and operated by us. The power and capacity generated by the Tucumán plant is delivered to CAMMESA pursuant to Energía Base.

#### San Miguel de Tucumán Power Plant

The San Miguel de Tucumán Power Plant has an installed capacity of 382 MW and is comprised of two GE 9001E gas turbines (GT), with evaporative cooling, a dual-pressure Alstom steam turbine without reheat (ST), and two CMI HRSGs, with supplementary burners operating as Combined Cycle. The heat rate of the Combined Cycle plant is approximately 7.830kJ /MWh with an efficiency of 47%. This plant is fueled with natural gas which, pursuant to Resolution No. 1/2019, is supplied by CAMMESA. The plant is connected to the SADI at 500 kV and 132 kV.

The first gas turbine became operational in 1995 as an Open Cycle. The second gas turbine and the operation of the Combined Cycle commenced in 2002. The San Miguel de Tucumán plant is capable of starting up without voltage (black start).

The San Miguel de Tucumán plant is wholly-owned and operated by us. The power and capacity generated by the plant is delivered to CAMMESA pursuant to Energía Base.

#### *El Bracho GT*

El Bracho GT is part of our Tucumán Complex and has an installed capacity of 267 MW. The turbine operated in this plant is a GE 9FA.04 gas turbine, and is the latest version of the 9FA gas turbine marketed by General Electric as of the date of this offering memorandum. The turbine has a robust design, specifically conceived for the long-term power generation service. The 9FA gas turbine design is one of the most proven designs available in the market, with over 200 units installed worldwide and over 12 million operating hours since 2016. The plant was built by General Electric under a turnkey contract and began commercial operations in January 2018.

The plant operates on natural gas only, as it is conveniently located near to the natural gas injection points and the pipelines inside the project site. The power is connected to the SADI at 500 kV located in the surrounded area.

In order to fund this project, our wholly-owned subsidiary, Y-GEN II, which owns the El Bracho GT plant, entered into a syndicated loan with Citigroup Global Markets Inc., Credit Suisse Securities (USA) LLC and Export Development Canada, as lenders. The loan is for an aggregate principal amount of US\$149.5 million, maturing in June 2022. Since it is a project finance loan, the lenders have no recourse against us.

El Bracho GT is wholly-owned and operated by us (through our subsidiary YGEN II). The power and capacity generated by the plant is sold to CAMMESA pursuant to PPAs entered into under Resolution No. 21/2016. The fuel is supplied by CAMMESA pursuant to the terms of the PPAs.

#### *Loma Campana I*

Loma Campana I is an Open Cycle plant with an installed capacity of 105 MW, located in Añelo, Province of Neuquén and was built on land we lease from YPF. The plant was built under a turnkey contract entered into with General Electric, which was in charge of the supply of the equipment and civil works. This plant began commercial operations in November 2017.

The plant relies on a General Electric LMS100 gas turbine and is connected to the SADI at 132kV through the EPEN transformer station and, for the provision of fuel, the plant is connected to the Gasoducto del Pacifico. The plant uses raw water cooling from two fracking retention basins located 13.5 km east of the plant site.

Loma Campana I is wholly-owned and operated by us. We sell the power generated by this plant to YPF pursuant to a power availability and operation and maintenance agreement, entered into under Resolution No. 269/08 (from the Secretary of Energy of the former Federal Planning, Public Investment and Services Ministry), pursuant to which YPF is responsible for the gas supply to Loma Campana I.

#### *Loma Campana II*

Loma Campana II is an Open Cycle plant with an installed capacity of 107 MW, located in Añelo, Province of Neuquén and was built on land we lease from YPF. The plant was built under a turnkey contract entered into with General Electric, which was in charge of the supply of the equipment and civil works. This plant began commercial operations in November 2017.

The plant relies on a General Electric LMS100 GT turbine connected to the SADI at 132 kV transformer station located 2.2 Km to the north. This project was developed and built in 13 months, and began commercial operations in November 2017. This plant used the same transmission line of 132 kV as Loma Campana I that connect



to the substation of the EPEN. The connection and transmission connections from Loma Campana I and Loma Campana II are independent.

In order to fund this project, our subsidiary, Y-GEN, which owns the plant, entered into a syndicated loan with Citigroup Global Markets Inc., Credit Suisse Securities (USA) LLC and Export Development Canada, as lenders. The loan for the project is for an aggregate principal amount of US\$70 million, maturing in June 2022. Since it is a project finance loan, the lenders have no recourse against us.

Loma Campana II is wholly-owned and operated by us (through our subsidiary YGEN). The power and capacity generated by the plant is sold to CAMMESA pursuant to PPAs entered into under Resolution No. 21/2016. Pursuant to such PPA, the natural gas used by the plant is supplied by CAMMESA, at its expense.

On July 1, 2019, the unit installed in Loma Campana II suffered a failure in the intermediate pressure turbine (IPT) speed sensor. After an inspection made by General Electric, the unit showed the need of an IPT replacement. A provisional IPT will be delivered, in accordance with the agreement entered into with General Electric, and the unit is expected to be in service again by the end of July 2019. Until such provisional replacement is delivered and the unit repaired, Loma Campana II will be unavailable. The provisional IPT will be working until the original one is repaired according to the agreement.

#### *Loma Campana Este*

Loma Campana Este is a motor-generator plant with an installed capacity of 17 MW. It is located within the Loma Campana oil and gas production concession block, in Añelo, Province of Neuquén and has 12 Jenbacher J420 power generating units in place (alternative motors). This plant began commercial operations in July 2017.

These units were acquired by Banco Supervielle from General Electric and then leased to us and we lease it to YPF, which uses it to supply energy for its non-conventional upstream operations in the Vaca Muerta oil formation. We operate this plant pursuant to an equipment lease agreement between us and YPF. Pursuant to the terms of the agreement, the natural gas for this plant is supplied by YPF according to its power supply needs. The agreement has a term of three years, renewable up to five years. The Loma Campana Este Thermal Power Plant operates as a power self-generator for YPF, and is not connected to the SADI.

#### *LPC I*

In February 2018, effective as of January 5, 2018, we acquired the LPC I power plant from Central Puerto S.A., for a purchase price of US\$31.5 million (plus VAT). The plant is located inside the La Plata Refinery owned by YPF, and has an installed capacity of 128 MW. The plant began commercial operations in 1997.

The plant is located in La Plata, Province of Buenos Aires, and is comprised of a single GE MS-9001E combustion turbine and a Nooter Eriksen single pressure HRSG that produces up to 200 tons of steam per hour, which is sold to YPF. The gas turbine and supplementary duct burners are mainly fueled with natural gas. Natural gas is replaced for gasoil in times of shortages primarily due to seasonal factors. However, in recent years, the consumption of liquid fuels has been reduced due to the incremental availability of natural gas.

The power generated by the plant is delivered to CAMMESA under Energía Base and the steam is delivered to YPF pursuant to a Steam Purchase Agreement. The natural gas for power generation is currently supplied by CAMMESA, according to Resolution No. 19/2016, and the natural gas for steam generation is supplied by YPF.

#### *Central Dock Sud*

We also have an indirect equity interest of 30.76% in CDS. Central Dock Sud plants are located in Avellaneda, Province of Buenos Aires, to the south of the City of Buenos Aires and are comprised of a 797.5 MW Combined Cycle and 72 MW Open Cycle plants, respectively.

### Central Dock Sud Combined Cycle

The Central Dock Sud Combined Cycle plant has an installed capacity of 797.5 MW and is comprised of two Alstom GT 26A gas turbines (GT), an Alstom steam turbine (ST), and an Alstom HRSG unit. The plant is fueled with natural gas, gasoil and biodiesel (up to 15%). The plant is connected to the SADI under an interconnection agreement entered into with EDESUR S.A. The plant began commercial operations in June 2001.

The power and capacity generated by the Central Dock Sud Combined Cycle plant is delivered to CAMMESA pursuant to Energía Base. In November 2018, through Resolution No. 70-SGE/2018 optional fuel purchases by generators were authorized. The call for statements of variable production costs is voluntary and renewable fortnightly. The generation costs with own fuel will be enhanced through the acknowledgement of the variable production costs by CAMMESA. Also, CAMMESA will continue with the commercial management and fuel dispatch for those agents who do not exercise this option. During December 2018, the plant purchased natural gas for generation through interruptible natural gas agreements in the market. Natural gas transport and distribution services to Central Dock Sud Combined Cycle plant is provided by Metrogas S.A., pursuant to the foregoing and also, additionally, and pursuant to Resolution No. 70-SGE/2018, interruptible transport agreements with carrier companies.

The power produced by the Combined Cycle plant in 2018 amounted to 3,929.5 GWh, with natural gas and gasoil consumption of 751,440 Dm<sup>3</sup> and 20,595 m<sup>3</sup>, respectively.

### Central Dock Sud Open Cycle

The Central Dock Sud Open Cycle plant has an installed capacity of 72 MW and is comprised of two General Electric Frame 6B gas turbines (GT). The plant is fueled with natural gas or gasoil. The plant is connected to the SADI under an interconnection agreement entered into with EDESUR S.A. The plant began commercial operations in July 1989.

The power and capacity generated by the Central Dock Sud Open Cycle plant is delivered to CAMMESA pursuant to Energía Base. The natural gas is supplied by CAMMESA, while MetroGAS S.A. is in charge of transporting it to the plant. The power produced by both gas turbines in 2018 was 20.3 GWh, with natural gas and gasoil consumption of 7,308 Dm<sup>3</sup> and 522 m<sup>3</sup>, respectively.

### ***Our Operating Renewable Energy Plants***

#### *Manantiales Behr Wind Farm*

This wind farm is located in the Golfo San Jorge Basin, inside the Manantiales Behr reservoir, in the Province of Chubut, approximately 40 km to the northwest of the City of Comodoro Rivadavia. The Manantiales Behr wind farm has an installed capacity of 99 MW. The installation has been completed in two stages of 49.5 MW each. A total of thirty 3.3 MW VESTAS IEC IB Class V-112 wind turbines have been installed, with an 84-meter high hub and a 112-meter swept area, which are distributed across an area of 20 km<sup>2</sup>, which is equal to 200 m<sup>2</sup> per wind turbine.

This wind farm benefits from the natural wind conditions prevailing in the area. According to measurements we did prior to commercial operation of the project, the wind speed in the stage I area averaged 11.9 m/s, while the wind speed in the stage II area averaged 11.7 m/s. The wind farm is expected to have a load factor of 57.9%.

Each wind turbine generates electricity at low voltage, which is increased to the wind farm distribution voltage of 35 kV through a transformer located at the foot of each unit. Overhead internal distribution lines of 35 kV interconnect the wind turbines, which are distributed in six trunk lines and connected at medium voltage cells. The wind farm is connected to the SADI through a 21-km long high-voltage overhead line of 132 kV to the transformation station (SE Manantiales Behr) which we built and another new transformation station (SE Escalante) from the interconnection node to the transmission line.

The first stage of 49.5 MW, integrated by 15 wind turbines, had a COD in July 2018. We sell the power generated by this first stage to YPF pursuant to a PPA with a term of 15 years, at a price denominated in U.S. dollars.

This portion of the farm supplies 8% of YPF’s commitment to consume renewable energy under the Renewable Energy Law. Therefore, we entered into an additional PPA with YPF for a 15 years term, with a price denominated in U.S. dollars. The second stage of 49.5 MW was completed in December 2018. For the generation of this second stage we entered into a PPA for 29.3 MW with YPF with a term of a seven-year term and some other PPAs with private companies (Roca Argentina S.A., Coca-Cola FEMSA de Buenos Aires S.A., Toyota Argentina S.A., Profertil S.A., Nestle Argentina S.A. and Eco de los Andes S.A., among others) with terms of up to 21 years.

The following is a snapshot of the wind turbines currently located in the Manantiales Behr wind project:



In order to fund the construction and commencement of operations of the Manantiales Behr wind project, we entered into a loan agreement with the IIC, for an aggregate principal amount of US\$200 million. For a description of the loan, see “Management Discussion and Analysis –Liquidity and Capital Resources-Bank and Financing Agreements.”

## Our Projects

### Thermal Energy

	<b>El Bracho ST</b>	<b>LPC II</b>	<b>Manantiales Behr</b>
Location.....	Province of Tucumán	Province of Buenos Aires	Province of Chubut
Expected COD.....	4 <sup>th</sup> quarter 2020 <sup>(1)</sup>	2 <sup>nd</sup> quarter 2020	4 <sup>th</sup> quarter 2020
Awarded electric capacity	198 MW	Summer: 71.95 MW Winter: 80.62 MW	58 MW
Awarded price per MWh.	22,200 US\$/MW/Month	18,600 US\$/MW/Month	23.33 US\$/MW-h
Contract length .....	15 years	15 years	20 years
Power purchase agreement signing date .	December 19, 2017	December 19, 2017	December 28, 2018

(1) For circumstances beyond our control, the COD may occur after the outside date required under the applicable PPA. See “-El Bracho ST” in this section.

## *El Bracho ST*

Pursuant to Resolution No. 287/2017, we were awarded a project to convert our existing El Bracho GT Open Cycle plant into a Combined Cycle plant by adding a steam turbine, a HRSG, a steam turbine and a water-cooled condenser, a generator and a tower refrigeration system and other complementary systems. Upon completion of the project, the plant is expected to increase its installed capacity by 198 MW to reach a total installed capacity of 465 MW, with an efficiency ratio of up to 6,407 kJ / KWh (56.2%) at 27.0 °C and 60.0% relative humidity, becoming our largest thermal power plant.

On December 20, 2017, our wholly owned subsidiary, Y-GEN II, which owns the project, entered into a new turnkey EPC agreement with General Electric. Pursuant to the terms of such agreement, General Electric committed to complete the construction by June 2020, while the COD committed by Y-GEN II under the PPA with CAMMESA is August 2020.

The equipment acquired for this project includes a D650 steam turbine, an A74 Topair TEWAC 255, MVA, 18 kV, 0.85 pf generator, a horizontal-type HRSG with triple-pressure reheat, and supplementary containers and burners, along with all required accessory equipment. The new closed cycle unit will share substantially all of the facilities and services of our existing El Bracho GT plant, and the majority of the supplies (including, but not limited to, water, and chemicals) and other requirements for the operations will be supplied through the existing operations of the El Bracho GT plant. The burners of the HRSG conduits will require additional natural gas, which, in turn, will require a modification to the internal gas intake installation, making the connection to the gas pipeline operated by Transportadora de Gas del Norte S.A. (“TGN”) before its fourth regulator, requiring to TGN an authorization for a larger consumption without requiring modifications on the ES&M constructed by TGN. This project will connect to the SADI at 500 kV at the same transformer station as the El Bracho GT plant, which will be expanded adapting the protection line system and DAG.

In March 2019, General Electric notified us that part of the equipment GE has to provide for the completion of this project was lost due to an incident related to the ship that was carrying those materials to Argentina. Pursuant to the terms and conditions of the agreement with GE, GE assumes the risk of loss of the equipment until finalization of the construction. Such equipment was insured under marine cargo insurance and, after the incident, we claimed and on July 1, 2019 we received from the insurance company the reimbursement of the value of the equipment pursuant to the terms of the policy.

The loss of such equipment may cause some delays in completing the construction of the Combined Cycle as planned. Based on the information available as of the date of this offering memorandum, we estimate that this project will be completed by December 2020, which is beyond the committed COD we agreed with CAMMESA under the relevant PPA. Pursuant to the terms of that PPA, if the COD is not achieved within the agreed timeframe, CAMMESA may impose penalties of approximately US\$0.44 million per day capped at US\$26.4 million.

We are currently discussing with General Electric how to further mitigate the impact of the loss of this equipment and accelerate the construction of the closed cycle and, eventually, the reimbursement by General Electric of any penalty (or the portion thereof) that might be applied to YGEN II. In addition, and given the circumstances of the delay, we requested an extension, without any penalty, of the committed COD from CAMMESA and the SGE.

Y-GEN II has Delay Start Up Insurance Coverage (“YGEN DSU”) which covers the loss of profits in respect of the El Bracho ST project for delays of its COD. Such YGEN DSU covers loss of profits from July 2020 until June 2021. See “Risk Factors—Risks Relating to the Company—We may be subject to significant penalties or record lower revenues in case of non-compliance with our PPAs” and “Risk Factors—Risks Relating to the Company—We may experience difficulties obtaining the performance bonds that we require in the normal course of our operations or may face challenges in meeting potential reimbursement obligations arising therefrom.”

## *LPC II*

Pursuant to Resolution No. 287, we were awarded a new cogeneration project to be developed in the La Plata Refinery, which is owned by YPF, and located in the Province of Buenos Aires.

This project involves the installation of a gas turbine, its corresponding power generator and a HRSG. The gas turbine will be dual fuel and will run on natural gas, as main fuel, and on gasoil, as alternative fuel. The gas turbine will be a GE 6F.03 gas turbine, with an installed capacity of 85 MW (ISO condition). The HRSG will generate 200 tons of steam per hour with additional burners and 140 tons of steam per hour without additional burners. This project will connect to the SADI at 33 kV through the SE 193 plant station located within the La Plata refinery.

In connection with this project, we entered into an equipment supply agreement with General Electric, on December 29, 2017 and an EPC agreement with AESA, the company that will be in charge of the execution of the civil works and the assembly of the equipment furnished by GE. The COD is expected to be 28 months from the date of the EPC agreement.

#### *Manantiales Behr Thermal Plant*

This project involves the construction of a thermal power plant, with an initial power capacity of 58 MW and the availability to reach 90 MW in the second stage. The Manantiales Behr Thermal Power Plant will be set up with five Wärtsillä W20V31SG motor-generators with a nominal power capacity of 11.76 MW. Three more identical motor-generators will be added in case of expansion to the second stage. The guaranteed minimum power capacity of the Thermal Plant will be 58 MW and the guaranteed minimum efficiency will be 8.182 kJ/kWh.

The Manantiales Behr Thermal Plant will have a parking area, offices with meeting rooms, a dining room, bathrooms and dressing rooms for personnel. A maintenance workshop and warehouse (with special and reserved places for hazardous materials complying with the requirement of the Chubut environmental authority) will be constructed in a different building.

As part of this project, YPF will be responsible for the construction of the transformer station, the assembly of a high voltage power line of 132 kV from the power plant to the transformer station of the Manantiales Behr wind farm, which is connected to the Nueva Escalante transformer station through another high voltage power line of 132 kV that supplies the rest of the oilfields operated by YPF in the region of Chubut.

#### **Renewable Energy**

	<u>Cañadón León</u>	<u>Los Teros I</u>	<u>Los Teros II*</u>
		Province of Buenos Aires	Province of Buenos Aires
Location.....	Province of Santa Cruz	Aires	Aires
Expected COD.....	3 <sup>rd</sup> quarter 2020	1 <sup>st</sup> quarter 2020	4 <sup>th</sup> quarter 2020
Offtaker .....	CAMMESA	MATER	MATER
Awarded electric capacity .....	99 MW	123 MW	50 MW
Load Factor .....	52.9%	55%	57%
Contract length .....	20 years	10-20 years	N/A
Number of generators.....	29	32	N/A
Capacity per unit .....	4.2 MW	3.8 MW	N/A
Wind turbine provider .....	GE	GE	N/A

\* As of the date of this offering memorandum, this project is in process of undergoing equipment bidding process and negotiation of EPC Agreements.

Large users with a demand in excess of 300 KW of average annual consumption are required to source 20% of their power consumption from renewable sources by 2025. The renewable portfolio standard must be achieved gradually, with no less than 8% of renewable energy consumption by 2018. Consequently, the Ministry of Energy, by way of Resolution No. 281/17, established the regulatory framework enabling large users to buy electricity from renewable sources from private sector generators and establishing the conditions to grant priority dispatch. This means that the energy generated by renewable sources will have a priority to be dispatched into the SADI prior to non-renewable and less efficient generators, provided that the generator applies and obtains such privilege.

Against this backdrop, we have several projects underway to increase our renewable energy generation capacity with the goal of increasing our share in the renewable energy market.

### *Cañadón León Wind Project*

In 2017, the SEE awarded us the right to develop the Cañadón León wind project under the second round of the RenovAr 2.0 program for 99MW, although we expect to have an installed capacity of 120 MW to be connected to the SADI, out of which, 99 MW entered into a 20-year PPA with CAMMESA and the balance may be sold to private clients through PPAs. This project is located 25 km from Caleta Olivia, Province of Santa Cruz. We expect this project to reach commercial operation in the fourth quarter of 2019.

This wind farm will benefit from the natural wind conditions prevailing in the area. According to measurements we performed prior to launching the project and over the last 24 months, the wind speed in the area averaged 10.7 m/s. The wind farm is expected to have a load factor of 52.9%.

We invited ten companies to submit bids for equipment and construction of the wind farm and received seven firm bids. The process to select the builder and supplier of the equipment has been completed, with GE being awarded the project on December 28, 2018. The first topographic construction projects occurred in March 2019, and construction commenced in July 2019.

The following image shows the location of the Cañadón León wind project:

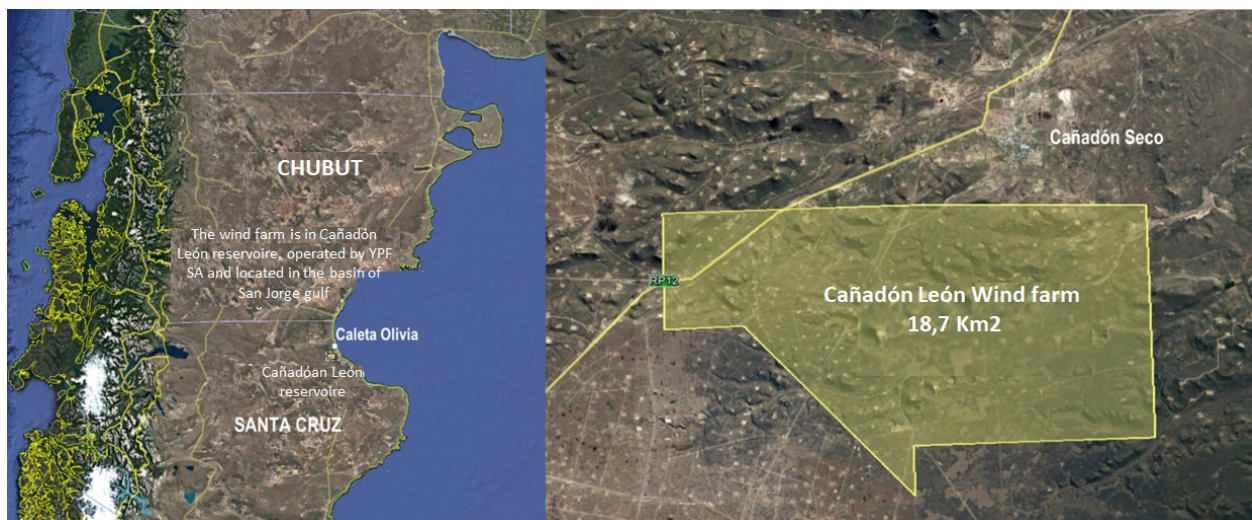

In April 2019, we entered into an agreement to expand the high voltage line which connects the transforming stations of Santa Cruz North and Caleta Olivia and enhance the transport network of the Province of Santa Cruz, allowing the dispatch of the energy that will be generated by the Cañadón León wind project. This project will consist of the following:

- Expansion of the high voltage transmission line of 132 kV, single circuit, which will connect the Santa Cruz North 500/132 kV transforming station with the Caleta Olivia E.T. 66/33 kV transforming station, both located in the Deseado region of the Province of Santa Cruz, with a length of 53 km.
- Expansion of Santa Cruz North 500/132 kV transforming station, equipment and civil construction of a line exit field of 132 kV.
- Expansion of Caleta Olivia 66/33 kV transforming station, construction of a line entry and transformation field of 132 kV with a sole switch.

### *Los Teros I Wind Farm*

We are building a wind generation project denominated Los Teros I. We acquired this project in May 2018, through the acquisition of all the equity interest in Luz del Cerro S.A. This project is located in Azul, Province of Buenos Aires and consists of the installation of 32 wind turbines generators. We expect to have an installed capacity of 123 MW which will be installed in two stages: the first stage will be of 72.2 MW and the second stage will be of 50.4 MW. The project contemplates all tasks, detail engineering development, the purchase of wind turbines, necessary supplies, services and permits to make the foundations and platforms of the wind turbines, access and internal roads of the wind farm, transport and erection of the wind turbines, the electric and control interconnection from every wind turbine to a new sub-station to be built on the SE Los Teros I wind farm. The new substation will have a voltage of 132 kV and will be connected to the SADI. Additionally, the commissioning works and PEM of every turbine and the wind farm as a whole are also contemplated, together with the installation and connection of measuring masts (one permanent and two temporary) for performance tests. The generated energy will be sent to the SADI in 132 kV, through an opening of the Olavarría-Tandil transmission line of 132 kV, which runs through the wind farm and at a distance of approximately 52 km from the city of Olavarría.

We expect this project to reach commercial operation in the first quarter of 2020. We expect to sell our capacity to private large users in the MATER. To achieve this, we have applied and obtained from the Secretary of Energy a priority dispatch for 121.8 MW of our installed capacity in Los Teros to be supplied to large users through PPAs.

This wind farm will benefit from the natural wind conditions prevailing in the area. According to measurements we did prior to launching the project and over the last 12 months, the wind speed in the area averaged 9.5 m/s. The wind farm is expected to have a load factor of 55.1%.

### *Los Teros II Wind Farm*

The Los Teros II wind farm project consists of the installation of wind turbines for 50 MW. We acquired this project in November 2018, through the acquisition of 100% of the shares of Luz del Valle S.A. The project contemplates all tasks, detail engineering development, purchase of wind turbines, necessary supplies, services and permits to make the foundations and platforms of the wind turbines, access and internal roads of the wind farm, transport and erection of the wind turbines, the electric and control interconnection from every wind turbine to the Los Teros I transforming station, together with the installation and connection of measuring masts (one permanent and two temporary). Additionally, the commissioning works and PEM of every turbine and the wind farm as a whole are also contemplated.

The wind turbines interconnection will be made through medium voltage lines which will connect to the Los Teros I wind farm substation, located approximately 13 km from the wind farm. In such substation, the distribution voltage stipulated in 33 kV will be elevated to 132 kV for its subsequent interconnection with the SADI in the Olavarría-Tandil line.

The venue provided for this wind farm is located 50 km to the south of Azul City, between Olavarría and Tandil, Province of Buenos Aires, Argentina (the same location as the Los Teros I wind farm).

We expect this project to start commercial operation in the fourth quarter of 2020. This project has been awarded a priority dispatch for 49.8 MW of its installed capacity to provision the MATER. As such, we expect to sell such capacity to large users through PPAs.

## **Our Remuneration**

### ***Energía Base***

Our Tucumán, San Miguel de Tucumán, LPC I and Central Dock Sud power plants operate under Energía Base. During the years ended December 31, 2018 and 2017, we sold approximately 6,131 GWh and 5,288 GWh of

electricity, respectively. These revenues accounted for 34.4%, 45.9% and 92.7% of our revenues for the years ended December 31, 2018 and December 31, 2017 and for the three-month period ended March 31, 2019, respectively.

Until February 2017, the price paid by CAMMESA under Energía Base program was based on a fixed and variable cost arrangement established by the Secretary of Energy, pursuant to the provisions of Resolution SE No. 95/13, as amended. Such price was denominated in pesos and adjusted by the Secretary of Energy on an annual basis. On February 2, 2017, Resolution No. 19/17 replaced Resolution No. 95/13. Such resolution established a new pricing arrangement for existing generators, providing incentives to increase the capacity and power not committed under the contracts executed under the Energía Plus program. The prices under Energía Base program are set in U.S. dollars and payable in pesos at the exchange rate published by the Central Bank on the date immediately before the payment date.

On the other hand, the incentives for thermal power generation entailed special pricing arrangements applicable to generators, which were required to report their power availability to CAMMESA and honor their commitments to guarantee such availability, in exchange for the price set under Resolution No. 19/2017. Certain other incentives were provided to encourage efficiency in the operation of thermal power plants.

Resolution No. 19/2017 from the former Secretary of Electric Energy set forth an updated payment arrangement and pre-established guarantees through several technologies. The price for thermal power generation was structured as follows:

- Price for Capacity: It represented the average monthly availability of the power plant, excluding any scheduled maintenance. The price was stated in US\$/MW/month and was calculated on the basis of the following factors: (i) a minimum price for capacity by technology and scale; (ii) a base price as per the offered guaranteed capacity, at US\$7,000 /MW/month; and (iii) an additional price for the additional offered availability. Unavailability due to fuel shortage was considered CAMMESA's risk and did not adversely affect the price for capacity.
- Price for Generated Power: The price for the power generated was US\$5 /MWh for all technologies running on whatsoever fuel. Additionally, energy operated under the optimal dispatch criteria was remunerated US\$2/MWh
- Additional Efficiency Incentive: CAMMESA granted benefits for improvements in the operating efficiency of each thermal power plant.

These prices did not include any compensation for the use of fuels by such power plants since, pursuant to Resolution SEE No. 19/17, the fuel for thermal plants was supplied by CAMMESA, which was not part of our costs.

On February 28, 2019, with the purpose of securing sustainability of the wholesale electricity market, the Secretariat of Renewable Resources and Electricity Market issued Resolution No. 1 /2019, pursuant to which the remuneration established in Resolution No. 19/2017 of the former Secretary of Electric Energy was adjusted. This resolution will be temporary until the implementation of the regulatory mechanisms to achieve a competitive and sustainable electricity market is completed.

The new remuneration for thermal generators is comprised of a monthly payment for available power, a payment for generated power and a payment for operated power.

- Remuneration for available power. Power availability remuneration is subdivided into a base price associated with the DRP and a price for guaranteed power in compliance with the DIGO. Power remuneration will be adjusted depending on the actual usage factor of generation equipment. The DRP remuneration will range from US\$3,050 to US\$5,200/MW-month, according to the technology made available for the system, and the DIGO remuneration will be US\$7,000/MW-month for winter and summer periods and US\$5,500/MW for the rest of the year.
- Remuneration for Generated Energy. The remuneration for the generation of conventional thermal generation will contemplate as a maximum, per type of fuel consumed by each generation unit, the non-



fuel variable costs, which are US\$4/MW hour for equipment consuming natural gas, US\$7/MW hour for fuel oil or gasoil, US\$10/MW hour for biofuels and US\$12/MW hour for mineral coal.

- **Remuneration for Operated Energy.** Additionally, generators will receive monthly remuneration for operated energy, represented by the integration of hourly power capacities for the period, valued at US\$1.4/MWh for any type of fuel. The hourly volume of operated energy must correspond to the optimum dispatch in order to comply with the energy and reserves assigned.

This new remuneration is denominated in U.S. dollars and is payable at the reference exchange rate for the date prior to the maturity date.

### ***Our PPAs and other long-term sale agreements***

#### *Thermal Power Plants*

The below table sets forth details of the installed capacity of each of our thermal power plants committed under long-term sale agreements:

<b>Plant</b>	<b>Counterparty</b>	<b>Contracted Capacity</b>	<b>Average Price for Capacity<sup>(3)</sup></b>	<b>Average Price for Electricity<sup>(3)</sup></b>	<b>Type of fuel</b>	<b>Term (in years)</b>	<b>Commencement Date</b>	<b>Expiration Date</b>
El Bracho GT	CAMMESA	267 MW	18,600 US\$/MW/ Month	11,32 US\$/MWh	Natural gas supplied by CAMMESA <sup>(1)</sup>	10	January 27, 2018	January 26, 2028
El Bracho ST (Closing Cycle)	CAMMESA	198 MW	22,200 US\$/MW/ Month	5 US\$/MWh	N/A	15	Committed COD: 3 <sup>rd</sup> quarter, 2020 <sup>(4)</sup>	August 23, 2035
Loma Campana I	YPF	105 MW	27 US\$/MWh/ Month	N/A	Natural gas supplied by YPF under a power availability and operation and maintenance agreement <sup>(2)</sup>	15	November 15, 2017	November 14, 2032
Loma Campana II	CAMMESA	107 MW	20.272 US\$/MW/ Month	8,95 US\$/MWh	Natural gas supplied by CAMMESA <sup>(1)</sup>	10	November 30, 2017	November 29, 2027
Loma Campana Este	YPF	17 MW	16.51 US\$/MW-h	22.51 US\$/MWh	Natural gas supplied by YPF under a power availability and operation and maintenance agreement <sup>(2)</sup>	3	July 13, 2017	July 11, 2020
LPC II	CAMMESA	85 MW	18,600 US\$/MW/ Month	8 US\$/MWh	Natural gas and gasoil to be supplied by YPF <sup>(1)</sup>	15	Committed COD: April 15, 2020	April 14, 2035
Manantiales Behr Thermal Plant	YPF	58 MW	23.33 US\$/MW-h	6.56 US\$/MWh	Natural gas to be provided by YPF	20	Committed COD: November 26, 2020	November 25, 2040

(1) Pursuant to the terms of the PPAs, fuel is supplied by CAMMESA free of charge.

(2) Fuel is supplied by YPF free of charge.

(3) During 2018.

(4) For circumstances beyond our control, the COD may occur after the outside date required under the applicable PPA. See “-El Bracho ST” in this section.

### Thermal Power-Related PPAs with CAMMESA

#### *Loma Campana II PPA and El Bracho GT PPA*

On March 22, 2016, by way of Resolution No. 21/2016, the Secretary of Electric Energy announced that a bidding process would be conducted for the installation of new generation capacity to be available in the summer (November-April) of 2016/2017, the winter (May-October) of 2017, or the summer (November-April) of 2017/2018. As a result of such bidding, we were awarded the following PPAs for a term of 10 years, with prices denominated in U.S. dollars, for the sale of an aggregate average monthly capacity of 367 MW:

- a PPA for our Loma Campana II power plant, entered into by and between CAMMESA and Y-GEN on August 4, 2016 (the “Loma Campana II PPA”); and
- a PPA for our El Bracho GT power plant, entered into by and between CAMMESA and YGEN II on July 1, 2016 (the “El Bracho GT PPA”).

According to the terms of each PPA and the applicable laws and regulations, the price payable to us by CAMMESA is made up of two main components:

- a payment for fixed capacity (the “Fixed Capacity Payment”), which comprises a fixed price per MW per month for our contracted capacity under each PPA (the “Contracted Capacity”). In order to receive the entire Fixed Capacity Payment, our Contracted Capacity must be fully available, upon CAMMESA’s request, to deliver the service (excluding schedule maintenance periods, restrictions on fuel supply imposed by CAMMESA, or reduced transmission), as per monthly measurements; and
- a variable payment (the “Variable Payment”), which comprises a variable price based on the actual amount of electricity generated by us and supplied to CAMMESA upon request. The Variable Payment is conceived to cover the operational and maintenance costs (excluding fuel consumption) incurred by us on the basis of the amount of power we generate and the type of fuel we use.

As per our estimates, 91% and 94% of our revenues derived from Loma Campana II and El Bracho GT, respectively, will be made up of Fixed Capacity Payments, with the remaining portion being represented by Variable Payments based on the operating costs (excluding fuel consumption) incurred in generating the power supplied by us. In addition, the price paid by CAMMESA under the PPAs includes a sum which accounts for the reimbursement of transmission charges and costs paid to the ENRE and CAMMESA, as determined on the basis of the information published by CAMMESA every month.

The Variable Payment comprises a variable charge based on the actual amount of power that we generate and supply to CAMMESA upon request. The Variable Payment is conceived to cover the operational and maintenance costs (excluding fuel consumption) incurred by us on the basis of the amount of power we generate and the type of fuel we use.

The Fixed Capacity Payment is reduced to US\$5 per MW per hour for any portion of our Contracted Capacity which is not made available when so required by CAMMESA to deliver the service (“Unavailability Charge”), with a multiplier factor to be applied in the first and second year of two and 1.5 times, respectively. Such Unavailability Charges increase to US\$10 per MW per hour if unavailability takes place upon a system power outage. The total Unavailability Charges applied in any month may not exceed 50% of the applicable Fixed Capacity Payment. However, any substantial, repeated or lengthy failure to supply the Contracted Capacity may purport to an event of default under the applicable PPA and may entitle CAMMESA, at its discretion, to terminate the applicable PPA.

The PPAs do not set forth payment terms; instead, such agreements make reference to the applicable rules and regulations set forth by Secretariat of Electric Energy Resolution No. 61/1992, as amended and modified (the “Rules and Regulations”), which may be subject to changes from time to time. Following a review of the PPAs, the Rules and Regulations and informal inquiries to CAMMESA, the understanding is that payments will be made by CAMMESA within 39 days (plus two business days required to make the necessary wire transfers) based on the

LVFVD, with the amounts being adjusted (up or down) in pesos, on the basis of the reference U.S. dollar exchange rate prevailing on the business day in which such payment is made. However, the fact that payment terms are not specifically set forth in the PPAs, but rather contained in (and subject to) the applicable Rules and Regulations (which are subject to change), entails a risk of change in the applicable law in respect of the PPA payment terms.

In accordance with Section 5 of the applicable Rules and Regulations, CAMMESA shall make all payments to the WEM creditors out of its available funds, and - in respect of each liability - it shall first settle interest accrued on outstanding principal and then the outstanding principal. In addition, the oldest liabilities are required to be settled first (in the order as incurred). If CAMMESA's funds are not sufficient to settle overdue payments, Section 3.14 of Resolution No. 21 sets forth that the effective PPAs entered into with CAMMESA shall have the same payment priority as the effective PPAs entered into with BICE as trustee.

Under the Loma Campana II PPA, the Fixed Capacity Payment is equal, on average, to US\$20,272 per MW per month, and we will receive a Variable Payment of US\$8.95 per MW/h for sales of electricity generated from natural gas.

Under the El Bracho GT PPA, the Fixed Capacity Payment is equal, on average, to US\$18,600 per MW per month, and we will receive a Variable Payment of US\$11.32 per MWh for sales of electricity generated from natural gas - the sole type of fuel used by the GT.

Under these PPAs, the fuel required for the operation of our power plants is natural gas, which will be supplied by CAMMESA. The inability of our power plants bound by these PPAs to make available the Contracted Capacity by reason of CAMMESA's failure to supply fuels will not result in a reduced monthly capacity availability calculation or in the application of Unavailability Charges.

Under each PPA, CAMMESA's obligation to supply or reimburse the fuel to us is limited to the Guaranteed Heat Rate as follows:

- According to the Loma Campana II PPA, the Guaranteed Heat Rate of each unit is 2,072 kcal/kWh in winter and 2,093 kcal/kWh in summer running on natural gas as sole fuel.
- According to the El Bracho GT PPA, the Guaranteed Heat Rate of each unit is 2,248 kcal/kWh for natural gas.

The fuel used by the generating units in excess of the Guaranteed Heat Rate is deducted monthly from the payments made by CAMMESA at the purchase prices established by CAMMESA.

The effective term of each PPA will commence on the date committed under the respective PPA (the "Committed Date") for the respective COD of each power plant and will expire within 10 years from the Committed Date. The effective term of Loma Campana II PPA commenced on November 30, 2017, its Committed Date, and will expire on November 29, 2027. The effective term of El Bracho GT PPA commenced on January 27, 2018, four days before its Committed Date (expected to take place on January 31, 2018), and will expire on January 26, 2028.

#### *El Bracho ST and LPC II PPAs*

By way of Resolution No. 287/2017, the Secretary of Electric Energy announced a bidding process for tenders from interested parties in selling electricity generated from newly installed capacity, using either (a) Closing Combined Cycle, or (b) cogeneration technology, with the commitment of making it available to meet the WEM demand. As a result of such bidding, we were awarded the following projects: (i) a cogeneration unit with a capacity of 80.62 MW in winter and 71.95 MW in summer located in YFP's La Plata Refinery (the "LPC II PPA") and (ii) through YGEN II, the El Bracho GT closing cycle, which will add a capacity of 198 MW through conversion into a 465 MW Combined Cycle (the "El Bracho ST PPA").

According to the terms of each PPA and the applicable laws and regulations, the price payable to us is made up of two main components:

- a fixed capacity payment (the “Fixed Capacity Payment”) which consists of a fixed price per MW per month for our contracted capacity under each PPA (the “Contracted Capacity”). In order to receive the entire Fixed Capacity Payment, our Contracted Capacity must be fully available, upon CAMMESA’s request, to deliver the service (excluding schedule maintenance periods, restrictions on fuel supply imposed by CAMMESA, or reduced transmission), as per monthly measurements, and
- a variable payment (the “Variable Payment”) which consists of a variable charge based on the actual amount of power that we generate and supply to CAMMESA upon request. The variable payment is conceived to cover the operational and maintenance costs (excluding fuel consumption) incurred by us on the basis of the amount of power we generate and the type of fuel we use.

As per our estimates, 76% and 86% of our revenues derived from LPC II and El Bracho ST, respectively, will be made up of Fixed Capacity Payments, with the remaining portion being represented by Variable Payments based on the operating costs (excluding fuel consumption) incurred in generating the power supplied by us. In addition, the price paid by CAMMESA under the PPAs includes a sum which accounts for the reimbursement of transmission charges and costs paid to the ENRE and CAMMESA, as determined on the basis of the information published by CAMMESA every month.

The Variable Payment consists of a variable charge based on the actual amount of power that we generate and supply to CAMMESA upon request. The Variable Payment is conceived to cover the operational and maintenance costs (excluding fuel consumption) incurred by us on the basis of the amount of power we generate and the type of fuel we use.

The Fixed Capacity Payment is reduced to US\$5 per MW per hour for any portion of our Contracted Capacity which is not made available when so required by CAMMESA to deliver the service (“Unavailability Charge”). Such Unavailability Charges increase to US\$10 per MW per hour if unavailability takes place upon a system power outage. The total Unavailability Charges applied in a given month may not exceed 50% of the applicable Fixed Capacity Payment in any month and 100% of the applicable Fixed Capacity Payment in a year. However, any substantial, repeated or lengthy failure to supply the Contracted Capacity may purport to an event of default under the applicable PPA and may entitle CAMMESA, at its discretion, to terminate the applicable PPA.

Under these PPAs, the fuel required for the operation of our plants (natural gas or gasoil, in the case of LPC II Cogeneration Plant) will be supplied by YPF under a preliminary agreement entered into with this company before the bidding, whereby we acquire natural gas for the LPC II power plant and the El Bracho GT power plant, at 82% of CAMMESA Reference Fuel Price and gasoil at 95% of CAMMESA reference fuel price. The inability of our power plants to make available the Contracted Capacity by reason of YPF’s failure to make such fuels available will result in a reduced monthly capacity availability calculation or in the application of unavailability charges. Upon conversion of El Bracho GT from an Open Cycle into a Combined Cycle, this fuel supply regime shall apply to our full generation capacity.

Under each of these PPAs, CAMMESA’s obligation to supply or reimburse the fuel to us is limited to the Guaranteed Heat Rate, as follows:

- According to the LPC II PPA, the Guaranteed Heat Rate of each unit is 1,680 kcal/kWh for natural gas and 1,820 kcal/kWh for gasoil.
- According to the El Bracho ST PPA, the Guaranteed Heat Rate of each unit is 1,530 kcal/kWh for gas natural (working as combined cycle).

The fuel used by the generating units in excess of the Guaranteed Heat Rate is deducted monthly from the payments made by CAMMESA at the purchase prices established by CAMMESA.

As guarantee of compliance with the committed COD, surety bonds were posted for the benefit of CAMMESA in the amount of (i) US\$8,352,144, under the LPC II PPA, and (ii) US\$26,373,600 under the El Bracho ST PPA. A penalty will be applied upon failure to meet the committed COD which, if not paid in due time and form,

will enable CAMMESA to execute the guarantee delivered to it. Each of these PPAs will be terminated by operation of law if the committed COD is not met within a term of 180 days, notwithstanding the execution of the guarantee by CAMMESA.

Under the El Bracho ST PPA, the Fixed Capacity Payment is equal to US\$22,200 per MW per month and we will receive a Variable Payment of US\$5 per MW/h for sales of electricity generated from natural gas.

Under the LPC II PPA, the Fixed Capacity Payment is equal to US\$18,600 per MW per month and we will receive a Variable Payment of US\$8 per MWh for sales of electricity generated from natural gas or gasoil.

The effective term of each PPA will commence on the date committed under the respective PPA (the “Committed Date”) for the respective COD of each power plant and will expire within 15 years from the Committed Date. The effective term of LPC II PPA commenced on April 15, 2020, its Committed Date, and will expire on April 14, 2035. The effective term of El Bracho ST PPA on August 24, 2020, its Committed Date, and will expire on August 23, 2035. For circumstances beyond our control, the COD of El Bracho ST may occur after the outside date required under the applicable PPA. See “-El Bracho ST” in this section.

#### Other Thermal Power Plants-Related PPAs

##### *Loma Campana I PPA*

By way of Resolution No. 307/2016, the Secretary of Electric Energy authorized us to act as distributed self-generator for the WEM in respect of its 105 MW Loma Campana I power plant. Accordingly, a power availability and operation and maintenance agreement was entered into with YPF involving the entire nominal capacity of the power plant, which will be allocated to YPF’s several consumption points (the “Loma Campana I PPA”).

According to the terms of the Loma Campana I PPA we receive US\$27 per MWh of monthly available capacity net of primary frequency regulation, on a take-or-pay basis, payable in Argentine pesos at the prevailing exchange rate of the U.S. dollar (spot rate) of the immediately preceding business day of the billing date.

Loma Campana I operates on natural gas only, which is supplied by YPF, at its exclusive expense, according to the consumption needs at each identified point.

The Loma Campana I PPA provides for compensation in case of termination at YPF’s fault, making up for the revenues remaining under the contract for the unexpired term.

The Loma Campana I PPA provides for a 15-year term as of November 15, 2017, the date committed under the PPA for the respective COD and will expire 15 years after the Committed Date, on November 14, 2032.

##### *Loma Campana Este PPA*

The agreement for availability of 17 MW generated by Loma Campana Este was entered into as a result of having been awarded the bidding process launched by YPF for the supply of distributed power in the area of Loma Campana reservoir (the “Loma Campana Este PPA”).

According to the Loma Campana Este PPA, the price payable to us is made up of two main components:

- a fixed capacity payment (the “Fix Capacity Payment”), which consists of a fixed price per MW per month for our contracted capacity under each PPA (the “Contracted Capacity”). In order to receive the entire Fixed Capacity Payment, our Contracted Capacity must be fully available, upon YPF’s request, to deliver the service; and
- a variable payment (the “Variable Payment”), which consists of a variable charge based on the actual amount of power that we generate and supply to YPF upon request.

According to the Loma Campana Este PPA, the Fixed Capacity Payment is equal to US\$16.51 per MW per month and we will receive a Variable Payment of US\$22.51 per MW/h, payable in pesos at the prevailing exchange rate of the immediately preceding business day of the payment date.

Loma Campana Este operates on natural gas only, which is supplied by YPF, at its exclusive expense, according to the consumption needs at each identified point. The agreement is for a term of 36 months commencing on July 11, 2017.

*Manantiales Behr Thermal Plant Agreement (under construction)*

The Manantiales Behr thermal plant will operate as a distributed self-generator for the WEM in respect of its 57.7 MW, pursuant to Secretary of Electric Energy Resolution No. 269/2008. To such end a power availability agreement was entered into with YPF involving the entire nominal capacity of the power plant (the “Manantiales Behr PPA”).

The Manantiales Behr thermal plant will operate on natural gas only, which shall be supplied by YPF at its exclusive expense based on YPF’s electricity consumption needs at each identified point. The agreement is for a term of 20 years commencing on November 26, 2020.

According to the Manantiales Behr PPA, the Fixed Capacity Payment is equal to US\$23.33 per MW per month and we will receive a Variable Payment of US\$6.56 per MW/h.

*Renewable Energy*

Below is a detail of our renewable energy generation assets committed under long-term sale agreements. Our third party PPAs related to the Los Teros I, Los Teros II and Manantiales Behr (Phase 2) projects are not described in the table (except for the PPA with YPF) since the terms and conditions of the PPAs entered into with private large users may vary significantly. The weighted average life for such PPAs entered into with private clients is 13.4 years.

<u>Plant</u>	<u>Counterparty</u>	<u>Contracted Capacity</u>	<u>Average Price for Capacity</u>	<u>Average Price for Power</u>	<u>Term (in years)</u>	<u>Commencement Date</u>	<u>Expiration Date</u>
Manantiales Behr Phase 1	YPF	49.5 MW	N/A	69 US\$/MWh	15	August 2018	July 2033
Manantiales Behr Phase 2	YPF	29.3 MW	N/A	69 US\$/MWh	7	December 2018	December 2025
Cañadón León Wind Farm	CAMMESA	99 MW	N/A	41.50 US\$/MWh(1)	20	Estimated COD: Third quarter 2020	Fourth quarter 2039

(1) *Awarded Price.* The price payable is broken down into an Awarded Price times the Annual Adjustment Factor and the Incentive Factor as specified in the Bidding Terms and Conditions of the RenovAr Program.

As of the date of this offering memorandum, we had 342 MW of installed capacity of each of its renewable energy generation assets committed under PPAs with private large users, including YPF.

*PPA entered under MATER*

We have entered into a 15-year PPA with YPF for a capacity of 49.5 MW and a power delivery commitment of 210,240 MWh/year (the “Manantiales Behr PPA”). The Manantiales Behr PPA entered into force in August 2018 on the COD of the Manantiales Behr wind farm first phase. The power was agreed upon to be delivered at the Escalante Transforming Station, the point at which the power plant is connected to the SADI. The Manantiales Behr PPA is structured on a take-or-pay basis, with an annual adjustment factor denominated in U.S. dollars and payable in Argentine pesos at the prevailing exchange rate –selling spot-of the immediately preceding business day of the payment date. The Manantiales Behr PPA provides for compensation in case of termination at YPF’s fault, making up for the revenues remaining under the contract for the unexpired term.

In addition, we have entered into a PPA with YPF for an installed power capacity of 29.3 MW from the Manantiales Behr wind farm second stage, for a term of seven years. This agreement entered into force on December 22, 2018, with a sale price payable in Argentine pesos at the prevailing exchange rate corresponding to the immediately preceding business day of the payment date. The remaining installed power capacity of the Manantiales Behr wind farm is currently committed to diverse private sector entities (Roca Argentina S.A., Coca-Cola FEMSA de Buenos Aires S.A., Toyota Argentina S.A., Profertil S.A., Nestle Argentina S.A. and Eco de los Andes S.A., among others).

As established by Resolution No. 281/2017 enacted by the former Ministry of Energy, since the fourth quarter of 2017, the Manantiales Behr wind farm has been awarded priority dispatch in the MATER for its 99 MW installed capacity.

We are also discussing several other PPAs with manufacturing facilities and other users from the private sector to supply them the power generated by the Los Teros I and Los Teros II projects which were awarded priority dispatch to the SADI for 173 MW in MATER transportation capacity.

### Cañadón León PPA

We entered into a PPA with CAMMESA for a capacity of 99 MW of our 120 MW Cañadón León wind farm for a term of 20 years, as a result of the last bidding process held under the RenovAr 2.0 Program (the “Cañadón León PPA”). The Cañadón León PPA was executed on November 23, 2018, with a sale price of US\$41.50 /MWh, to be multiplied by an adjustment factor and an incentive factor, both set forth in the bidding terms and conditions of the RenovAr 2.0 Program.

### Steam purchase agreements of Cogeneration Plants

Our cogeneration assets committed under long-term sale agreements are listed below:

Plant	Counterparty	Contracted Volume	TOP/DOP	Steam Price	Fuel	Term (in years)	Commencement Date	Expiration Date
LPC I	YPF	190/210 TN/h	100%	6.77 US\$/tn <sup>(1)</sup>	Natural Gas supplied by YPF	15	January 1, 2018	April 4, 2033

<sup>(1)</sup> Such price is adjusted as per an updating formula.

In February 2018, effective as of January 5, 2018, we started to supply steam to YPF from our LPC I power plant, pursuant to a steam sale agreement subject to a 15-year term (the “LPC I Steam Sale Agreement”). Pursuant to the LPC I Steam Sale Agreement, we agreed to deliver a volume from 190 tn/h to 210 tn/h, subject to a take or pay agreement by YPF equal to 190 tn/h, and YPF supplies any necessary fuel, as the case may be, for generation of electric power and the resulting steam. The price for the steam was agreed at US\$6.77/tn and the LPC I Steam Sale Agreement is limited in terms of liability for both parties at US\$31.5.

### **Competition**

The demand for energy and power in Argentina is satisfied by several public and private generating companies. Due to a small gap between supply and demand for energy in Argentina (which has given rise to voluntary and required electric power outages at times of peak seasonal consumption), there has been no material competitive pressure in the Argentine electricity industry in the last 12 years.

In the first quarter of 2016, the energy shortage was estimated at 3.5 GW, based on information published by CAMMESA, which resulted in significant volumes of electricity imports, mainly from Brazil. In addition, the energy generation business – mainly thermal generation – is characterized by a need for material expenditures in fixed assets and technology advances: two aspects which create a barrier to entry into the market. The increase in demand expected to occur in the following years in addition to a need for recovery of reserves and for replacement of inefficient plants in the generating complex, requires material investments in new generation of electric power. Our thermal plants in operation and under construction rank among the most efficient in terms of operation in the market. Consequently, we

believe that there will be no significant competitive pressure in the generation market in Argentina in the short and medium term that may have an adverse impact on the generation volumes from our plants.

In addition, the shortage of electric power reserves is a relevant issue in the Argentine government's agenda when it comes to electric power, as shown by the bidding processes organized under Resolution No. 21 and Resolution No. 287.

In order to reduce the power shortage, pursuant to Resolution No. 21, the former Secretary of Energy released a call for tenders to install new thermal generation units expected to start operations between the summer 2016/2017 and the summer 2017/2018, pursuant to which it offered to generators long-term PPAs with CAMMESA denominated in U.S. dollars. The call for bids was released for 1 GW, and bids were received for 6,607 MW out of which 2,872 MW were awarded. In May 2017, the Secretary of Energy called for bids to install new cogeneration and Combined Cycle generating units pursuant to Resolution No. 287 intended to satisfy WEM's demand and improve efficiency of the thermal complex. CAMMESA received bids for 3,300 MW of new thermal generating capacity, and awarded 1,810 MW expected to become operational in 2020-2021.

In the electricity generating market, we face competition from widely renowned companies operating on a permanent basis, such as Pampa Energía S.A., Central Puerto S.A., AES Argentina Generación S.A., Enel S.A. and Albanesi S.A.

In the call for bids for thermal generation, MSU and Araucaria Energy, which were part of a strong competition and were awarded PPAs, appeared as new market players in addition to our main traditional competitors such as Pampa Energía S.A., Central Puerto S.A. and Albanesi S.A.

In order to meet the goals of incorporation of renewable energies into the energy system as established by the Renewable Energy Law, the former Ministry of Energy launched the RenovAr Program, which as of the date of this offering memorandum included two bidding rounds for the award of renewable energy purchase agreements with CAMMESA subject to a 20-year term and prices denominated in U.S. dollars.

Pursuant to Round 1/1.5 released in 2016, bids were received for energy from wind, photovoltaic solar, biomass, biogas sources and small hydroelectric power sources for an aggregate 6,346 MW, and 2,423 MW were awarded.

Pursuant to Round 2 released in 2017 bids were received for an aggregate 9,401 MW, and 2,043 MW were awarded.

For bidding processes involving renewable energy, greater competition was observed, mainly including many new domestic and foreign players which expressed their interest in the bidding processes.

As a result of such awards, new competitors entered the renewable energy market such as Latinoamericana de Energía S.A., 360 Energy S.A., Petroquímica Comodoro Rivadavia S.A., Envision Energy Argentina S.A. and Genneia S.A.

## **Environmental Management**

As of the date of this offering memorandum, we are not a party to any pending legal proceedings or aware of any threatened legal proceedings involving environmental matters.

In addition, we have obtained all environmental permits required by applicable environmental laws and regulations and have environmental management plans approved by the relevant regulatory authority. In order to maintain the highest environmental standards, we perform regular controls the results of which fall within the limits permitted by current laws and regulations.

We have developed a comprehensive environmental compliance and management program subject to internal and external periodic audits by TÜV Rheinland and Bureau Veritas.



In order to comply with these policies, we secure quality assurance certifications from time to time. A number of audits for ISO certifications were performed and we secured the following certificates:

*Tucumán Complex (Tucuman Thermal Plant, San Miguel de Tucumán Thermal Plant, El Bracho GT and El Bracho ST):*

- ISO 14001/2015: Certificate No. 01 10406 105437 valid until May 28, 2021 (Tucumán plant and San Miguel de Tucumán plant); and
- ISO 50001/2011: Certificate granted on January 21, 2019 (certificate number still pending).

*LPC I plant:*

- ISO 14001/2004: Certificate No. 10406 105437.

*Loma Campana I and II, Loma Campana Este plants:*

- ISO 14001/2015: Certificate No. AR-0236480 valid until March 13, 2021; and
- ISO 50001/2011: Certificate IND 198554 valid until August 21, 2021 (certificate number still pending).

*Manantiales Behr wind farm:*

- ISO 14001/2015: Certificate No. AR-O237230 valid until January 14, 2022.

## **Safety and Health**

Occupational safety, hygiene and health management are intended to preserve the integrity of people as well as our own and third parties' property, on the assumption that:

- all workplace accidents and diseases are preventable;
- compliance with workplace safety, hygiene and health standards is the responsibility of all people engaged in performance of works at the power plants and wind farms; and
- raising awareness contributes to achieving well-being at the workplace and better personal and collective development of those who are members of the labor community.

Commitment towards "Ongoing Improvement" policies requires us to make changes in this policy and goals so that they always conform to the changes required by the market and current laws and regulations.

In order to comply with these policies, we secure quality assurance certifications from time to time. A number of audits for ISO certifications were performed and we secured the following certificates:

*Tucumán Complex:*

- ISO 9001/2015: Certificate No. 01 10006 1529715 valid until October 12, 2021 (Tucumán plant and San Miguel de Tucumán plant); and
- OHSAS 18001/2007: Certificate No. 01 11 306126082 valid until September 26, 2021.

*LPC I plant:*

- ISO 9001/2015: Certificate No. 01 10006 1629671 valid until July 12, 2019. Waiting for new certificate (recertification auditory approved on June 11, 2019).
- ISO 14001/2015: Certificate No. 01 10406 1629671 valid until July 12, 2019. Waiting for new certificate (recertification auditory approved on June 11, 2019).

*Loma Campana I and II, Loma Campana Este plants:*

- ISO 9001/2015: Certificate AR-O237236 valid until January 21, 2022.

**Insurance**

We maintain full-risk coverage against all insurable risks, including machinery breakdowns and business interruptions. This insurance provides coverage for damages and losses arising from earthquakes, hail, fire, lighting, floods and explosions for all our thermal plants and wind farms, among other events. We also maintain civil liability coverage for damages caused by us to third parties of up to \$400 million. We maintain full-risk coverage for our vehicles, buildings, personal property and electronic equipment. In addition, we usually acquire insurance against construction and assembling risks, with civil liability coverage, for the capital investment projects we undertake. We also maintain D&O insurance for civil liability as required by Argentine law.

We believe that the level of insurance coverage that we maintain is reasonably appropriate for the risks that our businesses face and are comparable to the level of insurance and reinsurance coverage maintained by other companies of comparable size operating in the businesses in which we are engaged.

**Employees**

Our labor force consists of permanent and temporary personnel which as of December 31, 2018, 2017 and 2016, totaled 292, 175 and 99 employees, respectively, and as of March 31, 2019, totaled 307 employees.

Our team consists of qualified professionals, technicians and experts with experience in the generation industry distributed among our power plants and corporate offices located at El Bracho (Province of Tucumán), Loma Campana (Province of Neuquén), Manantiales Behr (Province of Chubut), La Plata (Province of Buenos Aires), Los Teros, Azul (Province of Buenos Aires) and the City of Buenos Aires.

Nearly 55% of our employees hold positions that are not subject to collective bargaining agreements, while the remaining 45% is unionized under the following unions: (i) Federación Argentina de Trabajadores de Luz y Fuerza (FATLyF); (ii) Sindicato de Luz y Fuerza de Capital Federal (LyF Cap.); (iii) Sindicato Regional de Luz y Fuerza de la Patagonia (LyF Pat); (iv) Asociación de Profesionales Universitarios del Agua y la Energía (APUAYE); (v) Asociación del Personal Jerárquico del Agua y la Energía (APJAE); and (vi) Asociación del Personal Superior de Empresas de Energía (APSEE).

The following chart shows a breakdown of our payroll by geographic area and union as of March 31, 2019. As of the date of this offering memorandum we maintain excellent relationships with each of the union representatives, fostering productive and efficient operations.

	<u>Tucumán</u>	<u>City of Buenos Aires</u>	<u>Province of Buenos Aires</u>	<u>Province of Neuquén</u>	<u>Province of Chubut</u>	<u>Total</u>
Non-unionized...	26	103	17	6	19	171
Unionized	80	-	25	24	7	136
Total .....	106	103	42	30	26	307

The chart below shows the classifications of such personnel based on positions in effect as of March 31, 2019.

<b>Classification</b>	<b>Amount</b>
Management .....	14
Professional .....	163
Administrative .....	28
Technical-operative .....	102
Total .....	307

We believe the professional training of each employee is key to the ongoing organizational growth. For this reason, and to ensure that a high level of compromise and personnel motivation is maintained, we hold specific technical and generic training events, offer mobility opportunities, have management and leadership programs in place, among other actions.

## MANAGEMENT

### Board of Directors

In accordance with the provisions set forth in Article 12 of our bylaws and applicable law, we are managed by our board of directors which is currently composed of eight directors and up to eight alternate directors. Holders of Class A shares and holders of Class B shares have the right to appoint six and two directors, respectively, and up to six and two alternates, respectively. Directors are appointed for a term of three years and may be reelected for subsequent terms of three years indefinitely but, in any case, must remain in office until new directors are appointed by our shareholders meeting. See “Principal Shareholders–Shareholders’ Agreement.” Except for Hussain Shalchi, Amanuel Haile-Mariam and Patricio Martínez Morini, the members of our board of directors were elected at a shareholders’ meeting held on March 20, 2018. Patricio Martínez Morini was elected at a shareholders’ meeting held on May 7, 2019, and Hussain Shalchi and Amanuel Haile-Mariam were elected at a shareholders’ meeting held on May 28, 2019. The terms of all of the members of our board of directors expire in March 2021.

Our board of directors meets at least once every month and whenever the chairman of the board deems it necessary or at the request of the majority of our directors or of our supervisory committee. Extraordinary meetings of the board of directors may be called by any of the directors. Quorum for a meeting of the board of directors requires the presence of the majority of our directors, present in person by conference call or videoconference. Resolutions may be adopted by a majority of directors voting in person or cast by the means of communication referred to above, except for restricted matters contemplated in our Shareholders’ Agreement. See “Principal Shareholders–Shareholders’ Agreement.”

As long as Class A shareholders hold at least 24.5% of our capital stock, Class A shareholders shall have the right to appoint the Chairman of the board of directors and, as long as Class B shareholders hold at least 24.5% of our capital stock, Class B shareholders have the right to appoint the Vice Chairman of the board of directors.

Pursuant to section 59 of the General Corporations Law, directors have the obligation to perform their duties with the loyalty and the diligence of a prudent business person. Directors are jointly and severally liable to the company, the shareholders and third parties for the breach of their duties, the applicable law, our bylaws, and for any damage to these parties caused by fraud, abuse of authority or negligence, as provided for in Section 274 of the General Corporations Law.

Under the General Corporations Law, our board of directors is in charge of our administration and, therefore, makes any and all decisions in connection therewith, as well as those decisions expressly provided for in the General Corporations Law, our bylaws and other applicable regulations. Furthermore, our board of directors is generally responsible for the execution of the resolutions passed by shareholders’ meetings and for the performance of any particular task expressly delegated by the shareholders. Under the General Corporations Law, the duties and responsibilities of an alternate director, when acting in the place of a director on a temporary or permanent basis, are the same as those discussed above for directors, and they have no other duties or responsibilities as alternate directors.

The business address of our Class A directors is Macacha Güemes 515, C1106BKK, City of Buenos Aires, Argentina, and the business address of our Class B directors is Leandro N. Alem 882, C1001AAQ, City of Buenos Aires, Argentina. For more information regarding the governance of our board of directors, see “Principal Shareholders—Shareholders’ Agreement.”

Our directors and alternate directors as of the date of this offering memorandum are as follows:

<b>Name</b>	<b>Position</b>	<b>Class Designation<sup>(1)</sup></b>	<b>Date of Appointment</b>
Marcos Miguel Browne .....	Chairman and Director	Class A	March 20, 2018
Hussain Shalchi .....	Vice-Chairman and Director	Class B	May 28, 2019
Daniel Cristian González Casartelli .....	Director	Class A	March 20, 2018
Diego Martín Pando .....	Director	Class A	March 20, 2018
Luis Miguel Sas .....	Director	Class A	March 20, 2018
Patricio Da Re .....	Director	Class A	March 20, 2018

Name	Position	Class Designation <sup>(1)</sup>	Date of Appointment
Carlos Alberto Weis .....	Director	Class A	March 20, 2018
Raghuveer Kurada .....	Director	Class B	March 20, 2018
Juan Manuel Jasson .....	Alternate Director	Class A	March 20, 2018
Gastón Marcelo Laville Bisio .....	Alternate Director	Class A	March 20, 2018
Amanuel Haile-Mariam .....	Alternate Director	Class B	May 28, 2019
Carlos Alberto San Juan .....	Alternate Director	Class A	March 20, 2018
Fernando Gómez Zanou.....	Alternate Director	Class A	March 20, 2018
María Eugenia Bianchi Pintos .....	Alternate Director	Class A	March 20, 2018
Patricio Martínez Morini .....	Alternate Director	Class A	May 7, 2019

Note:—

(1) Refers to the class of shareholder that appointed such director. For a summary of the differences between our Class A and Class B shares, see “Principal Shareholders.”

Below is a summary of the professional background of our each of our directors.

*Marcos Miguel Browne.* Mr. Browne obtained a degree in industrial engineering from the Buenos Aires Technological Institute (*Instituto Tecnológico de Buenos Aires*), a master’s degree in business administration from Henley Management College in the United Kingdom and a certificate in natural gas management and economics from the College of Petroleum Studies, University of Oxford, United Kingdom. In addition, he completed a specialization in the economics of petroleum and natural gas at the Buenos Aires Technological Institute and a Management Development Program at IAE Business School. He has held several positions at YPF, including Head of Supply and Processing of Natural Gas from February 1994 to May 2000. He served as Head of the Gas and Liquid Gas Processing Business at Transportadora de Gas del Sur S.A. and held other roles there from June 2000 to March 2004. He is a founding partner of Endriven S.A. where he served as Director until March 2016. He also served as General Manager of Gas Meridional S.A., General Manager of C3Plus S.A. and President of Fuels Meridional S.A. Mr. Browne serves as Gas & Energy Executive Vice President of YPF since March 2016.

*Hussain Shalchi.* Mr. Shalchi holds a degree in law from the University College of London and a master’s degree in law from the University of Cambridge. He worked at Clifford Chance LLP from 2007 to 2015 and held the position of senior associate. His eight-year experience working at a top tier law firm in multiple locations, and four-year experience as an in-house counsel in the international energy and infrastructure finance business has given him deep domain knowledge in advising on global investments in the energy and infrastructure sectors. He is skilled in leading, managing and negotiating complex investments/divestments in jurisdictions across the world, including M&A, debt, equity and structured products, during the entire project cycle, from early stage development to operations phase. In 2015 he joined GE Capital as Managing Director and Global Counsel.

*Daniel Cristian González Casartelli.* Mr. González earned a degree in business administration from the Argentine Catholic University (*Pontificia Universidad Católica de Argentina*). He worked for the investment bank Merrill Lynch & Co. in Buenos Aires and New York for 14 years and held the positions of Head of Mergers and Acquisitions for Latin America and President for the Southern Cone (Argentina, Chile, Perú and Uruguay), among others. While at Merrill Lynch & Co., Mr. González played a leading role in several of the most important investment banking transactions in the region and was an active member of the firm’s global fairness opinion committee. He remained a consultant to Bank of America Merrill Lynch after his departure from the bank. Additionally, he has held the position of Head of Financial Planning and Investor Relations in Transportadora de Gas del Sur S.A. Currently, he is also a member of the Board of Directors of Adecoagro S.A. He has been a member of our Board of Directors since March 20, 2018. He was interim CEO of YPF from April 29, 2016 until June 30, 2016 and was Chief Financial Officer of YPF from July 2012 until April 2018. He has been the CEO of YPF since April 2018.

*Diego Martín Pando.* Mr. Pando holds a public accountant degree from the National University of Rosario (*Universidad Nacional de Rosario*), a master’s degree in Corporate Finance from CEMA University and a postgraduate degree in business administration from Austral University of Rosario (*Universidad Austral de Rosario*). He started his career at Arthur Andersen where he worked in the audit and corporate finance department. In 2002 he joined YPF working for one of its subsidiaries. Since 2005 he has held several positions in YPF and, currently, is the Controller and President of the Disclosure Committee of YPF.

*Luis Miguel Sas.* Mr. Sas holds a public accountant degree from the University of Buenos Aires (*Universidad de Buenos Aires*). He also holds a master's degree in business and administration from the IAE Business School and an executive program from Columbia University. He has an extensive background in corporate finance, financial operations, capital markets and finance. Prior to joining us, he worked in management positions at Petrobras, EDESUR S.A. and Pérez Companc S.A. He was a member of financial committees in various companies and responsible for conducting due diligence for various companies. In April 2018 he joined the Financial Vice Presidency of YPF and, currently, he serves as CFO of YPF.

*Patricio Da Re.* Mr. Da Re holds a public accountant degree from the University of Belgrano (*Universidad de Belgrano*). He holds a postgraduate degree in oil and natural gas economics from the Buenos Aires Technological Institute (*Instituto Tecnológico de Buenos Aires*), and in Negotiation and Conflict Resolution from ESEADE Business School. He currently serves as Planning and Business Development Manager at YPF. He served as Planning and Business Development Manager in YPF, and other positions within the natural gas industry since he joined YPF in 2002. He currently serves as Vice-Chairman of the Board of Directors of Metrogas S.A., director in Compañía Mega S.A., and other companies affiliated to YPF as director.

*Carlos Alberto Weis.* Mr. Weis holds a public accountant degree from the University of Belgrano (*Universidad de Belgrano*). He holds a postgraduate degree in Oil and Natural Gas from the Argentine Catholic University (*Pontificia Universidad Católica de Argentina*), and took different courses at the University of Texas in Austin and at the Massachusetts Institute of Technology. He also attended training courses in Management in IAE Business School. Mr. Weis is currently a member of the board of directors of MetroGas S.A. and Vice-Chairman of the board of directors of MetroENERGÍA S.A. He joined YPF in 1980 and, since then, he has held different managerial positions within YPF. He was an active member in the privatization process of YPF. He currently serves as Operations Manager of LNG in the Gas and Energy Executive Vice-Presidency of YPF.

*Raghuveer Kurada.* Mr. Kurada holds a master's degree in Business from Columbia University and a master's degree in Electric Engineering from the Rensselaer Polytechnic Institute in Troy, New York. He serves as managing director and head of Global Execution in GE EFS based in London, United Kingdom. His focus is on the expansion of General Electric investments in segments of the energy industry. Since March 20, 2018 he has been a member of our Board of Directors.

*Juan Manuel Jasson.* Mr. Jasson holds an industrial engineer's degree from the Buenos Aires Technological Institute (*Instituto Tecnológico de Buenos Aires*). He earned an MBA from Rotterdam School of Management, Netherlands. Since 2003, he has worked at Royal Dutch Shell, where he has held different positions in different countries. When in the Netherlands, between 2003 and 2010, he served as New Gas and LNG Businesses Development Analyst for America and Africa, and as Gas Supply Manager for Denmark. In 2004, he was a temporary member of the development team of Mariscal Sucre LNG based in Venezuela. In 2010, he served as Commercial Advisor of the Development Team of Canada LNG. Since 2011 and until 2017, he served as New Gas and LNG Businesses Development Manager in Brazil. In 2017, he joined YPF, where he currently serves as Chief of Midstream Projects and Energetic Efficiency.

*Gastón Marcelo Laville Bisio.* Mr. Laville Bisio holds a degree in economics from the University of Buenos Aires (*Universidad de Buenos Aires*), where he graduated *cum laude* in 2008. He has a decade of experience in the energy industry, holding positions related to market, investors, competence intelligence, asset and portfolio valuation, focused on upstream. In addition, he took training courses in project management, leadership and decision making and risk analysis, among others. He is currently working on the Gas and Energy Strategic Planning team of YPF.

*Amanuel Haile-Mariam.* Mr. Haile-Mariam joined GE Energy Financial Services in 2006 and has held various positions based in the United States, Hong Kong and Singapore, executing and managing large energy transactions around the world, including, Australia, North America (U.S. & Canada), Japan, South Asia, Association of South East Asian Nations (ASEAN) countries and Latin America. He is responsible for overseeing all capital market efforts to raise third party capital and investment syndication activities in the Americas. Mr. Haile-Mariam also serves as a board member on an energy fund.

*Carlos Alberto San Juan.* Mr. San Juan holds a law degree from the University of Buenos Aires (*Universidad de Buenos Aires*). He was an associate at Nicholson y Cano Abogados law firm from 1994 to 2000 and was a sole

practitioner from 2000 to 2003. In 2003, he joined the Legal Services Management group of YPF's Refining & Commercialization Department. From 2009 to 2014, he served as Neuquén-Río Negro Legal Services Manager, and between 2015 and 2017 he served as Legal Services Manager of Affiliates. Since September 2017, he serves as Natural Gas and LPG Legal Services Manager of the Legal Services Vice-Presidency of YPF.

*Fernando Gómez Zanou.* Mr. Gómez Zanou holds a law degree from the University of Buenos Aires (*Universidad de Buenos Aires*), a master's degree in Economics and in Business Administration from ESEADE Business School, and holds several postgraduate degrees in oil and gas. He joined YPF in 2004 and he currently holds the position of Corporate Legal Services Manager and was appointed director in several companies in the industry. He was previously a lawyer at different private companies, including Citibank, N.A. Sucursal Argentina, BASF Argentina S.A. and Auchan Argentina S.A.

*María Eugenia Bianchi Pintos.* Ms. Bianchi holds a law degree from the Argentine Catholic University (*Pontificia Universidad Católica de Argentina*). She holds a master's degree in Business Law from the University of San Andrés (dissertation in progress) and a postgraduate degree in oil and natural gas law from the University of Buenos Aires (*Universidad de Buenos Aires*). In addition, she attended the executive program on renewable energy from UCES University. She is a lawyer in the Natural Gas and Energy Management group of YPF Legal Services Senior Management department. Ms. Bianchi Pintos also serves as regular statutory auditor of CDS and Inversora Dock Sud.

*Patricio Martínez Morini.* Mr. Martínez Morini holds a public accounting degree from the Argentine Catholic University (*Pontificia Universidad Católica Argentina*) and a postgraduate degree in business management and several seminar degrees in leadership and oil & gas business. He joined YPF in 2004 and currently holds the position of Budget and Management Control Manager at YPF.

## Senior Management

Our senior management is in charge of the implementation and execution of our overall short-term and strategic objectives and reports to our chief executive officer. The table below sets forth our senior managers as of the date of this offering memorandum.

<b>Name</b>	<b>Position</b>	<b>Date of Appointment (*)</b>
Héctor Martín Mandarano.....	Chief Executive Officer	March 2018
Santiago Matías Sajaroff.....	Chief Operations Officer	March 2018
Sebastián Pablo Torres.....	Chief Compliance Officer	May 2018
Patricio Javier Cipollone.....	Commercial Manager	March 2018
Alejandro Avayú.....	Procurement and Supply Manager	March 2018
Gabriel Ábalos.....	Finance Manager	April 2018
Edgardo Javier Latessa.....	Quality, Environment, Security and Health Manager	March 2018
Jorge Esteban Ravlich.....	Strategical Planning and Business Development Manager	March 2018
Ricardo H. Castañeda.....	Legal Services Manager	March 2019
Julio Omar Francisco Temen.....	Engineering and Project Manager	March 2017
Leonardo Limoli.....	Central Dock Sud Commercial Manager	April 2018
Fernando Peralta.....	Tax Administration Manager	June 2018
Mariana Iribarne.....	Institutional Relationship Manager	June 2018
Tomás Gómez Álzaga.....	Human Resources Manager	May 2019

(\*) Date of admission or assignment of labor agreement to YPF Luz.

A brief biographical description of each of our senior managers is set forth below.

*Héctor Martín Mandarano.* Mr. Mandarano holds an engineering degree from the National Technological University in Buenos Aires (*Instituto Tecnológico de Buenos Aires*), holds a master's degree in Business

Administration from IAE Business School and a master's degree in Electric Market Management from Buenos Aires Technological Institute (*Instituto Tecnológico de Buenos Aires*). He has held different positions in the Argentine electrical and energetic sector, participating in studies of power systems or operations of high-voltage networks in Sociedad Anónima Centro de Movimiento de Energía (1997-2000), and of dispatch, and movement of energy at Pérez Companc (2000-2002). He also served as Electrical Business Department Manager at Petrobras Energía S.A. between 2002 and 2011, Director and Chief Executive Officer at Enecor (2007-2011), a member of the Management Commission of AGEERA (2007-2011), and Director at Distrilec (EDESUR) S.A. (2001-2011). In 2011, he joined YPF and served as Electrical Business Manager until 2016, when he took office as Executive Manager of the Electrical and Renewable Energy Business. He has served as our Chief Executive Officer since 2013, and was Director of Metrogas S.A. between 2014-2016 and since 2012 is the chairman of the Board of Directors of CDS.

*Santiago Matías Sajaroff*. Mr. Sajaroff holds a degree of Electrical Engineer from the National Technological University (*Instituto Tecnológico de Buenos Aires*), a master's degree in Electrical Market Management from the Buenos Aires Technological Institute (*Instituto Tecnológico de Buenos Aires*), and a master's degree in business administration (MBA) from the Argentine Catholic University (*Pontificia Universidad Católica de Argentina*). Before joining YPF, Mr. Sajaroff served as Senior Operations Manager of CDS for almost 10 years, and before that, he held different positions at the same company. At YPF he served as Commercial Manager of CDS, Electrical Business Commercial Manager of the YPF Gas and Energy Vice-Presidency, then as Technical Management, Projects and Constructions Manager of the Electrical Business of the YPF Gas and Energy Vice-Presidency and since 2018 as our Chief Operations Officer. In addition, since 2016, he has served as alternate director, then regular director, and currently as Vice-President of CDS.

*Sebastián Pablo Torres*. Mr. Torres holds a law degree from the University of Morón (*Universidad de Morón*), a master's degree in Business and Commercial Law from the University de Buenos Aires (*Universidad de Buenos Aires*) and was part of an Energy Business in management Executive Program at the Argentine Catholic University. Prior to joining us in May 2018, he had served in different positions in the Compliance and Legal areas of GE since 2001, including (i) Legal and Compliance Manager of GE Capital Argentina, (ii) M&A Compliance Manager Central America in GE Global Banking (based in Costa Rica), (iii) Chief Compliance Officer Latin America in GE Global Operations Finance, and (ii) Executive Compliance Manager Latin America in GE Global Law & Policy. Since May 2018, he serves as our Chief Compliance Officer. In addition, in January 2019 he took over the Internal Auditing Management. Also, since 2018 he serves as an alternate director of CDS.

*Patricio Javier Cipollone*. Mr. Cipollone holds a degree in Industrial Engineer from the National University of La Plata (*Universidade Nacional de La Plata*), and holds a specialization in Electrical and Natural Gas Market from the Buenos Aires Technological Institute (*Instituto Tecnológico de Buenos Aires*). Before joining YPF, he worked in the Commercial Management of AES Argentina Generación S.A. between 2006 and 2013, where he was a member of the board of directors of the Association of Electric Power Generators of the Argentine Republic (*Asociación de Generadores de Energía Eléctrica de la República Argentina*). From March 2013 to May 2014, he served as Commercial Manager of the Electrical Business of IEASA Large Plants. In June 2014, he joined the Commercial Management of the Electrical Business of YPF. From January 2016 to December 2016, he held the position of Commercial Manager of CDS. Since January 2017, he has been our Commercial Manager.

*Alejandro Avayú*. Mr. Avayú holds a public accountant degree from the University of Buenos Aires (*Universidad de Buenos Aires*), holds a master's degree in business administration from the Bolivian Catholic University in conjunction with Harvard University, and a postgraduate degree in business management from IAE Business School. He joined YPF in 1997, serving in Bolivia, Iran, Dubai and Iraq as finance controller and financial advisor. From 2013 to 2017, he served as Administration Manager of Marketing Companies of YPF. In August 2017, he joined us and in March 2018 he was appointed as our Procurement and Supply Manager.

*Gabriel Ábalos*. Mr. Ábalos holds a public accounting degree from University of Buenos Aires (*Universidad de Buenos Aires*), and earned a Certified International Investment Analyst Certificate issued by ACIIA - The Association of Certified International Investment Analysts®. He began his professional career in 1997 at Arthur Andersen, where he worked in the financial institutions auditing department. In 2003, he joined YPF, where he held several positions in accounting departments and was appointed Manager of Investor Relations and Head of Market Relations. In 2013 he was appointed Corporate Finance Manager, a position he held until he joined us as Finance Manager in April 2018.



*Edgardo Javier Latessa.* Mr. Latessa holds a civil engineer degree from the University of Buenos Aires (*Universidad de Buenos Aires*), occupational health and safety specialist engineer degree from the National University of Mar del Plata (*Universidad Nacional de Mar del Plata*) and natural gas and oil degree from the University of Buenos Aires. His professional career began in 2001, when he served as Site Supervisor of the Agency for the Control of Public Thoroughfare Concessions (OCCOVI). In 2004, he joined YPF, where he held different positions in the Environmental and Safety Department. In 2014, he was appointed Chief of the Environmental, Health and Safety Department of YPF, a position he held until he joined us in November 2017 as Quality, Environmental, Safety and Health Manager.

*Jorge Esteban Ravlich.* Mr. Ravlich holds a public accounting degree with a major in finance from the University of Buenos Aires (*Universidad de Buenos Aires*). He also holds an executive MBA degree from IAE Business School. His professional career began in 1997 at Pérez Companc S.A., Petrobras Argentina S.A. and Pampa Energía S.A. He served as director in different companies and industry associations, namely: director in Termoeléctrica Manuel Belgrano S.A. (2012/2017), director in Termoeléctrica San Martín S.A. (2012/2017), director in WEBSA S.A. (2012/2017), director and General Manager at Enecor S.A. (2008/2017), member of the board of directors of the Association of Electric Power Generators of the Argentine Republic (*Asociación de Generadores de Energía Eléctrica de la República Argentina*) (2008/2017), member of the board of directors of the Association of Electric Energy Transporters of the Argentine Republic (*Asociación de Transportistas de Energía Eléctrica de la República Argentina*) (2008/2013), and director of Distrilec S.A. (2012/2013). In 2017, he was appointed as our Strategic Planning and Development Manager.

*Ricardo H. Castañeda.* Mr. Castañeda holds a law degree from the Argentine Catholic University (*Pontificia Universidad Católica de Argentina*), a master's degree in Business Law from the Austral University (*Universidad Austral*) (2004-2005) and a master's degree in Corporate Law from the University of Buenos Aires (*Universidad de Buenos Aires*). Since 2008, he is admitted to practice as foreign legal consultant in the State of New York. He worked as a foreign associate at Allen & Overy law firm in New York. Since 2007, Mr. Castañeda is an assistant professor at the University of Buenos Aires (*Universidad de Buenos Aires*). Before joining YPF Luz, he worked in the Court of Commercial Matters No. 6 of the City of Buenos Aires from 1998 to 1999, as an associate lawyer at Matta & Trejo from 1999 to 2002, and as an associate lawyer at García Pullés, Calatrava & Asoc. from 2002 to 2004. In 2005 he joined Estudio O'Farrel as a senior associate and in 2011 he became a partner in the Corporate, Finance and Capital Markets Department. In March 2019, he joined YPF Luz as our Legal Services Manager.

*Julio Omar Francisco Temen.* Mr. Temen holds a degree in engineering from the University of Buenos Aires (*Universidad de Buenos Aires*), holds a postgraduate degree in management development from the Argentine Catholic University (*Pontificia Universidad Católica de Argentina*), and is preparing for his MBA dissertation from the Argentine Catholic University (*Pontificia Universidad Católica de Argentina*). He served as Medium Voltage Planner in EDESUR S.A., among others. Between 2005 and 2009, he served as head of Energy and Critical Infrastructure in IBM Argentina. Then, he served as Operations Manager of Agrekko Argentina until 2012. After that, he joined ABB Argentina, where he served as Project Manager for the Medium and High Voltage equipment and later as Business Unit Manager for Outdoor and Medium Voltage Protection products. In 2017, he joined YPF Luz and, currently, serves as Commercial Manager of CDS.

*Leonardo Limoli.* Mr. Limoli holds a public accountant degree from the Argentine Catholic University (*Pontificia Universidad Católica de Argentina*), a master's degree in Finance from the Argentine Catholic University (*Pontificia Universidad Católica de Argentina*), a master's degree in Finance from the Foundation of Financial Studies of Madrid, Spain and an EMBA from the IAE Business School. He started his professional career in 1998 at Pistrelli, Díaz y Asociados, and worked for Deloitte, Petrobras Argentina S.A. and Energía Argentina S.A. He joined YPF Luz in April 2018 to work in our Strategic Planning and Development Department. Mr. Limoli was appointed as a Commercial Manager at CDS in 2018.

*Fernando Peralta.* Mr. Peralta obtained a public accountant degree at the Argentine Catholic University (*Pontificia Universidad Católica de Argentina*), and a master's degree in business administration at the IAE Business School. He started his career in 1998 at Arthur Andersen, where he worked in the Energy Companies Audit area. From 2003 to 2007, he served as Head of Administration of Repsol YPF in Bolivia. In 2008, he was appointed Administration Manager in YPF, in 2014, he was appointed as Consolidation and Reporting Manager in YPF and in 2018 as our Tax Administration Manager.

*Mariana Iribarne.* Ms. Iribarne holds a degree in political science and economics from the University of Wake Forest, North Carolina, and a master’s degree in public administration from Columbia University in New York. She started her career in 1995 at the Ministry of Economy as a consultant in the National Secretary of Public Investment. Between 1997 and 2004 she was an economic advisor at the Embassy of Australia and between 2004 and 2008 she was an economic and commercial advisor of the European Union in Argentina. In 2008, she became corporate affairs manager of Intel Southern Cone, and between 2012 and 2017 she worked as public affairs manager at General Electric Argentina, giving support to all of the business areas of that company. Between 2017 and 2018 she was the public affairs manager at Visa for the Southern Cone. Mariana joined YPF Luz in June 2018 as the Institutional Relations Manager.

*Tomas Gomez Alzaga.* Mr. Gomez Alzaga holds a degree in law from the Argentine Catholic University (*Pontificia Universidad Católica de Argentina*), with specializations in Labor Relations from Torcuato Di Tella University, Collective Negotiation and Human Resources from Business Argentine University (*Universidad Argentina de la Empresa*) and Business Administration from IAE Business School. He has more than 16 years of management experience in human resources and labor relations in the oil & gas industry, working for companies such as Baker Hughes and San Antonio International, before joining YPF in January 2011. He has actively negotiated collective agreements in Argentina, Perú and Venezuela. In YPF, he worked in the Upstream Labor Relations area and as Human Resources Manager in the Drilling & Workover, Production and Fields of the Future departments, being his most recent assignment in YPF as Human Resources Manager of the La Plata Industrial Complex, in the Downstream Executive Vice-presidency. He joined us as our Human Resources Manager in May 2019.

### Supervisory Committee

Our bylaws provide for a supervisory committee (*comisión fiscalizadora*) composed of three statutory auditors (*síndicos*) and three alternate statutory auditors that serve for one fiscal year and may be reelected indefinitely. Pursuant to the General Corporations Law, only lawyers and accountants admitted to practice in Argentina or civil partnerships composed of such persons may serve as statutory auditors in an Argentine *sociedad anónima*.

The primary responsibilities of our supervisory committee are to monitor the management’s compliance with applicable laws, our bylaws, and our shareholders’ resolutions, and to perform other functions, including, but not limited to: (i) supervise and inspect the corporate books and records whenever necessary, but at least quarterly; (ii) attend meetings of the directors and shareholders; (iii) prepare an annual report concerning our financial condition and submit it to our shareholders at the ordinary annual meeting; (iv) call an extraordinary shareholders’ meeting when necessary, on its own initiative or at the request of the shareholders, or an ordinary one when our board of directors fails to do so; (v) supervise and monitor our compliance with applicable laws, our bylaws and the shareholders’ resolutions; and (vi) investigate written complaints made by shareholders representing at least 2% of the capital stock.

In performing these functions, the supervisory committee does not control our operations or assess the merits of the decisions made by the directors.

The following list includes the members of our statutory supervisory committee as of the date of this offering memorandum, who were appointed at the shareholders’ meeting held on May 7, 2019, and whose terms expire in December 2019. Members of the supervisory committee will nonetheless remain in office until new members are appointed.

<u>Name</u>	<u>Position</u>	<u>Class Designation</u>	<u>Date of Appointment</u>	<u>Member Until</u>
Luis Rodolfo Bullrich.....	Member	A	May 7, 2019	December 2019
Marcela Inés Anchava.....	Member	A	May 7, 2019	December 2019
Santiago Carregal.....	Member	B	May 7, 2019	December 2019
Nicolás Perkins.....	Alternate	A	May 7, 2019	December 2019
Francisco Muruzeta.....	Alternate	A	May 7, 2019	December 2019
Diego Agustín Chighizola.....	Alternate	B	May 7, 2019	December 2019

All of the members of our Supervisory Committee are independent pursuant to the provisions set forth in the Technical Resolutions and, consequently, pursuant to the CNV Rules.

For more information regarding our Supervisory Committee, see “Principal Shareholders—Shareholders’ Agreement.”

Below is a summary of the professional background of each of the members and alternate members of the Supervisory Committee:

*Luis Rodolfo Bullrich.* Mr. Bullrich holds a law degree from the School of Law of the University of Buenos Aires (*Universidad de Buenos Aires*), and holds a postgraduate degree in economics from ESEADE Business School at the Argentine Chamber of Commerce. He is a member of the Bar Association of the City of Buenos Aires. He has been recognized as a Leading Individual by the international publication Chambers & Partners, The Client’s Guide, 2016 in the Dispute Resolution section. Since 2001, has been a partner at Nicholson y Cano law firm, in charge of the Arbitration and Litigation department. He gives advice on legal issues to companies such as YPF, HSBC, ICBC, The Bank of Tokyo, Sancor, Ledesma, QBE, Zurich, Schlumberger, Mitsubishi and Panasonic, among other corporate clients.

*Marcela Inés Anchava.* Ms. Anchava holds a law degree from the University of Buenos Aires (*Universidad de Buenos Aires*). In the past, she was a partner at Cárdenas law firm and, since 2013, she is a partner at Nicholson y Cano Abogados law firm. Her areas of expertise are the corporate and antitrust fields. She is a statutory auditor of several companies affiliated to YPF.

*Santiago Carregal.* Mr. Carregal holds a law degree from the University of Buenos Aires (*Universidad de Buenos Aires*) and a master’s degree in law from the University of Illinois in the United States. He has worked as a foreign associate at Shearman & Sterling law firm, in New York, served as Vice-President and Assistant General Counsel at JPMorgan, Buenos Aires branch, and was partner at Carregal & Funes de Rioja law firm. He is currently partner and chairman at Marval, O’Farrell & Mairal and the head of its banking and finance department. He is a member of the Bank Lawyers Committee of the Argentine Republic, and is a postgraduate professor at the University of Buenos Aires (*Universidad de Buenos Aires*), Austral University (*Universidad Austral*) and the Argentine Catholic University (*Pontificia Universidad Católica Argentina*).

*Nicolás Perkins.* Mr. Perkins holds a law degree from the University of Buenos Aires (*Universidad de Buenos Aires*), a master’s degree in Comparative Jurisprudence from the New York University School of Law and an executive master’s degree in Business Administration from IAE Business School (magna cum laude). He is partner at Nicholson y Cano Abogados law firm, mainly focused on commercial and natural resources law. He was a director and member of the Audit Committee of Petrobras Energía S.A. (2004-2007), and since 2016 has been a director of Sociedad Anónima Importadora y Exportadora de la Patagonia (La Anónima), among other companies.

*Francisco Muruzeta.* Mr. Muruzeta holds a law degree from the Argentine Catholic University (*Pontificia Universidad Católica Argentina*). He is a partner at Nicholson y Cano Abogados law firm, mainly focused on corporate and antitrust law.

*Diego Agustín Chighizola.* Mr. Chighizola holds a law degree from the Argentine Catholic University (*Pontificia Universidad Católica Argentina*), a master’s degree in law from Columbia Law School, and a master’s degree in Finance from the University of CEMA. He was a foreign associate at Cleary, Gottlieb, Steen & Hamilton in New York. He is currently a partner at Marval, O’Farrell & Mairal, and is a specialist in banking and finance, capital markets, mergers and acquisitions, and development and financing of real estate projects. He is a Business Law professor at the University of San Andrés, and gives lectures in the University of CEMA and Austral University.

## **Compensation**

The Argentine General Companies Law No. 19,550 (the “Argentine General Companies Law”) provides that the compensation payable to all directors (including those directors who are also members of senior management) in a fiscal year may not exceed 5% of net profit for such fiscal year, if the company is not paying dividends in respect of

such net profit. The Argentine General Companies Law increases the annual limitation on director compensation to up to 25% of net profit if all the net profit for such year is distributed as dividend. Nevertheless, the Argentine General Companies Law establishes that a company's bylaws might provide other specific limits to directors' compensation, always within the aforementioned legal limits. The percentage decreases proportionally based on the relation between the net profit and the dividends distributed. The Argentine General Companies Law also provides that the shareholders' meeting may approve the remuneration of the directors above the limits set by the Argentine General Companies Law in case the company has no net profit or the net profit is low, if the relevant directors performed during such fiscal year special commitments or technical-administrative functions. The compensation of all directors and members of the supervisory committee requires shareholders' approval at a shareholders' meeting.

For the fiscal year ended December 31, 2018, the members of our Board of Directors and the Supervisory Committee have waived their right to receive compensation for performance of their duties. During 2018, our performance-based compensation programs included bonus scheme for approximately 160 non-unionized employees and 132 unionized employees.

Neither we nor any of our subsidiaries have entered into any other agreement that provides for any benefit or compensation to any other director or member of our supervisory committee after the expiration of his term or upon his retirement. We maintain D&O insurance for civil liability as required by Argentine law.

## PRINCIPAL SHAREHOLDERS

As of March 31, 2019, our subscribed capital was Ps. 3,747,070,355 represented by 2,810,302,991 Class A shares with Ps. 1 of nominal value and 1 vote per share, and 936,767,364 Class B Shares with Ps. 1 of nominal value and 1 vote per share. Our Class A shares and Class B shares are entitled to the same voting, distribution and liquidation rights, subject to the terms of our Shareholders' Agreement described below. Our capital is fully issued and paid.

As of the date of this offering memorandum, the composition of our share capital was the following:

	<b>Class of Shares</b>	<b>Number of Class A Shares</b>	<b>Number of Class B Shares</b>	<b>Percentage of Capital Stock</b>
YPF <sup>(1)</sup> .....	A	2,723,826,879	—	72.69%
OPESSA <sup>(1)</sup> .....	A	86,476,112	—	2.31%
GE EFS <sup>(2)</sup> .....	B	—	936,767,364 <sup>(3)</sup>	25.00% <sup>(4)</sup>
<b>Total</b> .....		<b>2,810,302,991</b>	<b>936,767,364</b>	<b>100.00%</b>

- (1) *OPESSA is a wholly owned subsidiary of YPF. YPF is the beneficial owner of 2,810,302,991 Class A shares, which represent 75.00% of our share capital. YPF's address is Macacha Güemes 515, C1106BKK, City of Buenos Aires, Argentina.*
- (2) *GE EFS is indirectly controlled by General Electric. General Electric is a company incorporated under the laws of the State of New York and is listed in the New York Stock Exchange.*
- (3) *The shares acquired by GE EFS, an affiliate of General Electric were partially paid in March 2018. The second installment of the subscription price was paid in March 2019 pursuant to the terms of the Subscription Agreement dated as of March 20, 2018 among us, YPF and GE EFS. For information on the pledge of this shares, see "Certain Relationships And Related Party Transactions – Acquisition of a 33.33% equity interest in each of Y-GEN and Y-GEN II from General Electric."*
- (4) *Shareholding rounded up from 24.99% for arithmetic purposes.*

General Electric has recently notified us that it currently intends to transfer its entire ownership in GE EFS to a General Electric controlled fund vehicle and expects this to happen in the near future. If the proposed transaction is consummated, General Electric will continue to control GE EFS but its economic rights with respect to GE EFS (and, consequently, the underlying proportion of the economic rights corresponding to the 24.99% of our share capital held by it) will be reduced by 50%.

### Shareholders' Agreement

On March 20, 2018, we and all of our shareholders entered into a shareholders' agreement which provides for the following key provisions:

#### *Appointment of Directors*

Our directors shall be appointed as follows:

- Class A shares have the right to appoint six directors and up to six alternate directors; and
- Class B shares have the right to appoint two directors and up to two alternate directors.

A director designated by a certain class of shares may exclusively be removed at any time by resolution of the holders of the class of shares that appointed such director. Alternate directors may only replace or substitute regular directors elected by the same class of shares that elected the relevant alternate director. In the event of absence or vacancy of a director for any reason whatsoever, he or she shall be automatically replaced by an alternate director or a new director elected by the shareholders of the class of shares that appointed the applicable director.

#### *Chairman and Vice Chairman*

As long as Class A shareholders hold at least 24.5% of our capital stock then outstanding, Class A shareholders shall have the right to appoint the Chairman of the board of directors and, as long as Class B shareholders

hold at least 24.5% of our capital stock then outstanding, the Class B shareholders have the right to appoint the Vice Chairman of the board of directors.

### ***Meeting of the Board of Directors, Quorum and Voting Requirements***

Unless otherwise agreed by our board of directors, regular meeting of the board of directors shall be held at least one every month or as provided in our bylaws. Extraordinary board of directors meetings may be convened upon notice by any director. Any decision or resolution at any meeting of our board of directors shall require a quorum of a majority of directors and such resolutions shall be validly approved by the affirmative vote of a majority of our directors entitled to vote on such decision, except for (A) certain restricted matters such as the adoption of our annual budget, approval of our business plan or the entering into any commercial agreement that, individually or in the aggregate, involves consideration in excess of US\$5,000,000 and not otherwise contemplated in the annual budget, in which cases the affirmative vote of at least one director appointed by the class of shares that holds at least 24.5% of our capital stock, is required; and (B) the approval of our annual budget, and variations from our annual budget greater than 10%, in which cases the affirmative vote of at least one director appointed by GE EFS is required, as long as GE EFS holds at least 12.45% of our capital stock.

### ***Supervisory Committee***

The members of the Supervisory Committee are appointed as follows:

- Class A shareholders have the right to appoint two regular members and two alternate members and appoint the Chairman of the Supervisory Committee; and
- Class B shareholders have the right to appoint one regular member and one alternate member and appoint the Vice Chairman of the Supervisory Committee.

In the event that each of Classes A and B hold 50% of our capital stock each, then the members of the Supervisory Committee will be appointed as follows:

- Class A shareholders have the right to appoint one member and one alternate member;
- Class B shareholders have the right to appoint one member and one alternate member; and
- both classes together shall appoint one member and one alternate member. In the latter case, the Chairman and the Vice Chairman of the Supervisory Committee shall be appointed on an annual basis alternatively by Class A and Class B shareholders.

In addition, if Class A shareholders hold more than 87.5% of our capital stock, then Class A shareholders shall have the right to appoint three regular statutory auditors and three alternate statutory auditors, and the Chairman and Vice Chairman of the Supervisory Committee.

In the event of absence or vacancy for any reason whatsoever of a regular member, he or she shall be automatically replaced, or otherwise at the next succeeding meeting of the Supervisory Committee, by an alternate member or a new member elected by the shareholders of the class of shares that appointed the applicable regular member.

### ***Executive Officers***

As long as Class A shareholders hold at least 24.5% of our capital stock, Class A shareholders shall have the right to nominate our Chief Executive Officer (“CEO”) and our Chief Operating Officer (“COO”), and the CEO and the COO of our subsidiaries, and Class B shareholders shall have the right to elect those who will serve as such from among the candidate nominated by Class A shareholders.

As long as Class B shareholders hold at least 24.5% of our capital stock, Class B shareholders shall have a right to nominate our Chief Financial Officer (“CFO”) and our Chief Compliance Officer (“CCO”), and the CFO and the CCO or our subsidiaries, and Class A shareholders shall have the right to elect those who will serve as such from among the candidates nominated by Class B shareholders.

Such approvals shall not be unreasonably withheld or delayed.

### ***Transfer of Shares***

The Shareholders’ Agreement also contains certain restrictions on the transfer of our shares including rights of first refusal and tag along rights applicable to transfer of shares other than to affiliates of the shareholders.

### ***Preferential Right to Supply***

Provided that the terms applicable to the supply of product or service are on an arms’ length basis and in our best interests:

- GE shall have a preferential right to supply our equipment (and provide maintenance services in respect thereof);
- YPF shall have a preferential right to supply natural gas to be used in our thermal power plants; and
- AESA shall have a preferential right to provide us EPC services.

### ***Non-Compete and Business Opportunities***

Except for limited exceptions, none of our shareholders may, or may hold any equity interest in any entity that, competes with us or owns assets that compete with those owned by us.

In addition, subject to the specific terms set forth in the Shareholders’ Agreement, in the event that one of our shareholders intends to pursue business opportunities in Argentina related to the electric power generation or transportation, it shall give notice to the other shareholders in order to determine whether such opportunity will be developed directly by us.

### ***Dividend Policy***

We shall maximize dividend distributions to our shareholders, and shall distribute such dividends to the extent that: (i) such distributions are consistent with a prudent financial policy; and (ii) we have sufficient funds or are projected to have sufficient funds to fund the equity portion of all of the projects approved by our board of directors at the time of the dividend distribution determination.

## CERTAIN RELATIONSHIPS AND RELATED PARTY TRANSACTIONS

The following discussion is a brief summary of certain material arrangements, agreements and transactions we have with related parties. We are also engaged in other transactions with related parties that we do not perceive as material.

We have engaged, and in the future may engage, in transactions with related parties. We believe that any related party transactions and operations with related parties we have entered in the past have been in the ordinary course of business, on an arm's length basis and in accordance with usual market practices. Pursuant to the terms of the Shareholders Agreement entered into by us, YPF and GE, AESA has a preferential right to provide us with EPC services, General Electric has a preferential right to supply us turbines, generators and other equipment (and provide maintenance services in respect thereof) and YPF has a preferential right to supply us with natural gas to be used in our thermal power plants, in each case, provided that such sales and services are rendered on an arm's length basis and in our best interest.

Our related party transactions are detailed in Note 26 to our Audited Annual Financial Statements and Note 27 to our Unaudited Interim Financial Statements. Below is a summarized description of our most relevant related party transactions.

### Sale of electricity to CAMMESA

CAMMESA is a not-for-profit entity in which the Argentine government has a 20% equity interest. For more information about CAMMESA, see "The Argentine Electric Power Sector – Compañía Administradora del Mercado Mayorista Eléctrico S.A. (CAMMESA)." We have entered into PPAs with CAMMESA for certain of our operating plants and for certain of our projects. For a description of our PPAs with CAMMESA, see "Business—Our Remuneration—Our PPAs and other long term agreements." In addition we provide energy to CAMMESA under Energía Base. For a description of the terms of Energía Base, see "Business—Our Remuneration—Energía Base."

CAMMESA is our main purchaser of our electric energy. The following table provides the balances as of March 31, 2019, December 31, 2018 and 2017, and transactions consummated with CAMMESA during the three-month period ended on March 31, 2019 and during the fiscal years ended on December 31, 2018 and 2017.

		<u>Trade Receivables</u>	<u>Other current receivables</u>	<u>Other non-current receivables</u>
		(in thousands of Ps.)		
CAMMESA	03.31.2019	2,406,032	139,344	452,881
	12.31.2018	1,816,331	124,731	452,881
	12.31.2017	426,833	90,345	452,881
		<u>Revenues</u>	<u>Purchases of good and services</u>	<u>Interest</u>
		(in thousands of Ps.)		
CAMMESA	03.31.2019	1,977,170	12,319	14,613
	12.31.2018	5,881,414	128,426	37,028
	12.31.2017	1,363,882	54,696	88,520

### PPAs and other services agreements with YPF

We have entered into PPAs and other services agreements with YPF for the provision or generation of electric energy and other related services. For a description of those agreements, see "Business— Our PPAs and other long-term sale agreements" and note 26 to our Audited Annual Financial Statements and note 27 to our Unaudited Interim Financial Statements.



## **License Agreement with YPF**

We have entered into a License Agreement with YPF, dated as of March 13, 2018, for the use, among others, of “YPF Luz” and “YPF”. This agreement is for the exclusive use of such brands, free of charge and has a term of five years and is automatically extended for an additional year unless we give notice 30 days prior to the termination date.

## **Relationship Agreement with YPF**

We have entered into a relationship agreement with YPF, dated February 7, 2018, for the provision of certain transition services. Pursuant to the relationship agreement, we have the option to request YPF to provide us with accounting, human resources, finance, legal, tax, IT and other administrative services. These services will be available to us for up to one year counted from the signing date and may be extended for up to two additional one-year terms. The provision of any services may be terminated at our option upon 30-days’ notice.

## **EPC and Maintenance contracts with AESA**

In connection with the construction of LPC II power plant, we entered into a EPC Agreement by accepting AESA’s offer letter dated February 16, 2017, an affiliate of YPF, for the construction of the plant and the installation of a gas turbine and other related systems and equipment. The supply of the gas turbine and the related equipment will be provided by General Electric (See “—Supply Agreements with General Electric”). The total amount payable to AESA under the contract is US\$24,758,717 and Ps. 1,427,847,951. This total amount will be paid in different installments upon the completion of milestones. Pursuant to the terms of the agreement, AESA has provided a technical guarantee for the construction. The target date for the completion and delivery of the plant is April 20, 2020. AESA may incur penalties if the plant is not delivered by such date.

In addition, effective as of May 2, 2017, we entered into an Operating and Maintenance Agreement with AESA for the provision of certain services related to the operation and maintenance of Loma Campana Este power plant. Pursuant to the terms of the agreement we pay a fixed amount to AESA for such maintenance. The agreement has a term of 36 months counted from the execution of the agreement and shall terminate on the termination date of the PPA we entered with YPF for the sale of the energy generated by Loma Campana Este power plant.

## **Acquisition and sale of our equity interest in CDS**

On May 26, 2017, YPF contributed to us (i) a 42.86% equity interest in Inversora Dock Sud, which holds 71.78% equity interest in CDS, and (ii) a 9.64% equity interest in CDS. In exchange to such contribution, we issued 777,033,657 shares. Subsequently to the closing of the transaction, on March 1, 2018 we sold the 9.64% equity interest in CDS to YPF for a total consideration of Ps. 270,518,661.

## **Sale of the Ramos Area to YPF**

On February 2, 2018, we entered into an Asset Purchase Agreement by which we sold our 27% interest in the rights, titles, privileges, benefits and obligations over the Ramos Area to YPF. Such interest had been granted by means of National Decree No. 90/91 dated January 14, 1991 (as extended by Administrative Decision No. 92/96), including the participation over the exploitation concession granted in relation to the Ramos Area and the participation in the joint operation agreement of the Ramos Area called “Joint Operating Agreement for the Ramos Area Province of Salta” dated April 1, 1979 by and among Pluspetrol S.A., Techint Compañía Internacional S.A.I.C. and Selva Oil, Inc., as amended. Such assets had been allocated and contributed to us as part of the spin-off from Pluspetrol Energy S.A. and such disposition was made as part of our separation from YPF and with the purpose of concentrating our business on the generation of electricity. This transaction was considered as a reorganization for purposes of Argentine taxes. Following the completion of such transaction, AFIP communicated that no taxes were due related to this transaction.

### **Acquisition of a 33.33% equity interest in each of Y-GEN and Y-GEN II from General Electric**

On March 20, 2018, through a capital increase, we issued shares representing 24.99% of our capital and voting stock, to GE EFS pursuant to the terms of the subscription agreement dated February 6, 2018. The subscription price was (i) a fixed price of US\$275 million, and (ii) US\$35 million, as a contingent price. See “Business – History and Development.” On March 20, 2018, GE EFS’ 24.99% equity interest in us was pledged for the benefit of certain creditors and Citibank, N.A., Argentine Branch, as collateral agent. The terms and execution of the pledge shall at all times comply with the provisions of the Shareholders’ Agreement and the subscription agreement between us and GE EFS, dated February 6, 2018.

Simultaneously with the share subscription we acquired from GE Capital Global Energy Investments B.V. all of their interest (33.33% equity interest) in each of Y-GEN and Y-GEN II. Following such acquisition, we own 100% of the outstanding equity interest in each of Y-GEN and Y-GEN II.

### **Supply Agreements with General Electric**

We entered into an EPC Agreement with General Electric by accepting its offer letter dated February 16, 2017 for the design and construction of our El Bracho ST power plant. This is a full turnkey agreement and includes the provision of the steam turbine. Pursuant to the terms of the EPC Agreement, General Electric will design, build and install the steam turbine necessary to complete a Combined Cycle in our El Bracho power plant. The total amount of payable to General Electric under the agreement is approximately US\$273,677,000. Such amount will be paid in different installments upon the completion of certain advances. Pursuant to the terms of the agreement, General Electric provides a technical guarantee until the definitive acceptance by us of the plant. The committed date for the completion and delivery of the plant is June 20, 2020. General Electric may incur into penalties if the plant is not delivered by such date. For circumstances beyond our control, we may not complete this project as required under the applicable PPA. See “Business–Our Projects–Thermal Energy–El Bracho ST”.

In addition, we entered into a Supply Agreement with General Electric by accepting its offer letter dated December 29, 2017 for the acquisition of gas turbines, its corresponding power generator and a heat recovery steam generator for our LPC II project. Pursuant to the terms of the agreement, General Electric shall provide the gas turbine and other equipment which shall be installed by AESA in the designated site.

Both agreements provide guarantees, the usual supplemental services and other equipment to install, operate and maintain these turbines. For a description of the turbines we acquired from General Electric, see “Business–Our Operating Thermal Power Plants–LPC II” and “–El Bracho ST.”

In addition, we accepted certain offers from General Electric dated June 25, 2018 and July 4, 2018, to enter into a turnkey agreement for the supply, installation and commissioning of 32 wind turbines, for the construction of a wind farm with a power capacity of 123 MW located in Los Teros I, Azul, Province of Buenos Aires, Argentina. In accordance with the terms and conditions of such agreement, General Electric will design, build, supply and install the wind turbines in this wind farm. The total amount payable to General Electric for the provision and supply of the wind turbines as well as for the assembly, installation and commissioning of the wind turbines will be approximately US\$138,648,699. The price will be paid based on: (i) milestones directly related to the provision and supply of the wind turbines and their auxiliary equipment; and (ii) by work progress certificates in relation to the assembly, installation and commissioning of the wind turbines. Pursuant to the terms of this supply agreement, General Electric granted a technical guarantee of the assembly, installation and commissioning work and for the wind turbines themselves. Such guarantee which will remain in force until our final acceptance of the wind farm. The date set for the completion and delivery of the wind farm is September 13, 2019 for the first stage of 73 MW, and October 25, 2019 for the second stage of the remaining 50 MW. General Electric may be subject to penalties if the wind farm is not delivered and completed within the established deadlines.

Lastly, we have entered into Operation and Maintenance Agreements (“O&M Agreements”) with General Electric for the provision of services related to the maintenance of certain of our turbines located in the San Miguel de Tucumán, Tucumán, Loma Campana I, Loma Campana II, El Bracho GT and LPC I power plants. Under the terms of such agreements, General Electric provides us with technical support related to the operation and maintenance of the turbines, performs certain routine maintenance of our turbines and, in certain cases, supplies the necessary spare

parts necessary for maintenance. As consideration for these services, we pay General Electric (i) a monthly fixed amount per agreement and per turbine upon which General Electric provides its services, and (ii) variable fee equal to a certain amount per hour of production of each turbine. The O&M Agreements with General Electric has a term of the earlier of a certain term (typically between 10 and 12 years depending on the technology and age of the turbines that such agreement covers) or a certain amount of production hours of the turbines. Under certain O&M Agreement, General Electric guarantees, provided we comply with the terms and conditions of the O&M Agreements, a minimum availability of the turbines.

### **Guarantee from YPF**

In connection with the IIC Loan Agreement, YPF has entered into a Guarantee Agreement, with IIC dated December 2, 2016 pursuant to which YPF has granted an unconditional and irrevocable guaranty in favor of IIC of all the payment obligations of YPF Luz under the terms of the loan. For this guarantee, since March 20, 2018, we have been obliged to pay YPF a fee equal to 1.25% of the outstanding principal amount under the terms of the loan agreement. For a description of the loan with IIC, see “Management Discussion and Analysis-Liquidity and Capital Resources-Bank Financings-IIC Loan.”

## DESCRIPTION OF THE NOTES

*The following is a summary of the material provisions of the Notes and the Indenture (as defined below) governing the Notes. Because this is a summary, it may not contain all the information that is important to you. The following is qualified in its entirety by reference to the Notes and the Indenture. You should read the Indenture in its entirety. Copies of the Indenture may be obtained as described under “Listing and General Information” in this offering memorandum.*

In this Description of the Notes, the “Issuer” refers only to YPF Energía Eléctrica S.A. and not to any of its subsidiaries. You can find the definitions of certain terms used in this description under “—Certain Definitions.”

The Notes will be issued under an Indenture to be dated as of July 25, 2019 (the “Indenture”) among the Issuer and The Bank of New York Mellon, as trustee (in such capacity, the “Trustee”), co-registrar (in such capacity, the “Co-Registrar”), principal paying agent (in such capacity, the “Principal Paying Agent” and, together with any other paying agents under the Indenture, the “Paying Agents”) and transfer agent (in such capacity, a “Transfer Agent” and, together with any other transfer agents under the Indenture, the “Transfer Agents”), Banco Santander Río S.A., as registrar (in such capacity, the “Registrar”), Paying Agent, Transfer Agent and representative of the Trustee in Argentina (in such capacity, the “Representative of the Trustee in Argentina”) and The Bank of New York Mellon SA/NV, Luxembourg Branch, as Luxembourg paying agent. The Indenture is not required to be qualified under the U.S. Trust Indenture Act of 1939, as amended, and will not incorporate, or be subject to, any of the provisions thereof.

The Notes will qualify as “*obligaciones negociables simples no convertibles en acciones*” under the Argentine Negotiable Obligations Law and will be entitled to the benefits set forth therein and subject to the procedural requirements thereof, and will be issued and placed in accordance with such law, the Argentine Capital Markets Law and the CNV Rules and any other Argentine applicable laws and regulations.

The Notes will be issued as “Series II Notes” under the Issuer’s US\$1,500,000,000 global note program. The creation of the note program was authorized by resolutions of the Issuer’s shareholders’ meeting dated March 16, 2018, and certain terms of the Program were approved by the board on March 16, 2019 by delegation of authority granted by the Issuer’s shareholders on March 16, 2018; and approved by the CNV by Resolutions No. RESFC-2019-20192-APN-DIR#CNV, dated April 17, 2019. The issuance of the Notes was approved at a meeting of the board of directors of the Issuer on July 17, 2019, pursuant to the powers delegated to the Issuer’s board of directors at a shareholders’ meeting dated March 16, 2018.

The Issuer will apply to list the Notes on the Luxembourg Stock Exchange and to have the Notes admitted for trading on the Euro MTF Market. The Issuer will also apply to have the Notes admitted for trading on the MAE. See “—Listing” below.

### Basic Terms of Notes

The Notes will:

- be issued in an original aggregate principal amount of US\$400,000,000;
- be direct, unconditional, unsecured and unsubordinated obligations of the Issuer;
- be equal in right of payment with all other existing and future unsubordinated, unsecured obligations of the Issuer;
- be senior in right of payment to all existing and future subordinated obligations of the Issuer;
- be effectively subordinated to all existing and future secured obligations of the Issuer, to the extent of the value of the assets securing such secured obligations;

- be subordinated in right of payment to liabilities preferred by applicable law (including those obligations preferred by statute or operation of Argentine law, such as, without limitation, labor and tax claims);
- be subject to optional redemption or tax redemption as described under “—Redemption and Repurchase;”
- mature on July 25, 2026, unless earlier redeemed or repurchased in accordance with the terms of the Notes (see “—Redemption and Repurchase” below); and
- accrue interest at 10.000% per year, payable semi-annually in arrears on each January 25 and July 25, commencing on January 25, 2020, to holders of record on the January 10 and July 10 immediately preceding the applicable interest payment date (whether or not a Business Day).

Interest on the Notes will accrue from the most recent date to which interest has been paid or, if no interest has been paid, from and including the Issue Date to, but excluding, the applicable interest payment date. Interest will be computed on the basis of a 360-day year of twelve 30-day months.

The Notes will be issued in minimum denominations of US\$1,000 and integral multiples of US\$1,000 in excess thereof. This offering will require a minimum subscription amount of US\$150,000. The Notes will be represented by one or more registered Notes in global form, except that in limited circumstances the Notes may be issued as certificated Notes.

#### **Additional Notes**

The Indenture by its terms will not limit the aggregate principal amount of Notes that may be issued thereunder and permits the issuance by the Issuer, from time to time without consent of holders of Notes outstanding, of additional Notes (“additional Notes”) under the Indenture having the same terms as the Notes, except with respect to the issue date, initial issue price and, if applicable, the first interest payment date, *provided* that, among other requirements, (i) no Default or Event of Default under the Indenture shall have occurred and then be continuing or shall occur as a result of such additional issuance and (ii) such additional Notes rank *pari passu* and have equivalent terms and benefits as the Notes offered hereby; *provided further* that, if the additional Notes are not fungible with the Notes for U.S. federal income tax purposes, such additional Notes will have a separate CUSIP number, ISIN number or other identifying number from the Notes offered hereby. The Notes offered hereby and any additional Notes would be treated as a single series for all purposes under the Indenture and will vote together as one series on all matters with respect to the Notes. Any issuance of additional Notes will be subject to all of the covenants in the Indenture, including the covenant described below under “—Certain Covenants—Limitation on Indebtedness.”

#### **Status and Ranking**

The Notes will be direct, unconditional, unsecured and unsubordinated obligations of the Issuer and will:

- rank equal in right of payment with all existing and future unsecured and unsubordinated obligations of the Issuer from time to time outstanding (except those obligations preferred by statute or operation of Argentine law, including, without limitation, labor and tax claims);
- rank senior in right of payment to all future subordinated indebtedness of the Issuer, if any;
- be effectively subordinated to all existing and future secured obligations of the Issuer, to the extent of the value of the assets securing such obligations; and
- be structurally subordinated to all existing and future indebtedness and other liabilities of any Subsidiary of the Issuer.

The Notes will qualify as “*obligaciones negociables simples no convertibles (en acciones)*” under the Argentine Negotiable Obligations Law, and will be entitled to the benefits set forth therein and subject to the

procedural requirements thereof. Under the terms of Article 29 of the Argentine Negotiable Obligations Law, Notes constituting negotiable obligations grant their holders access to summary judgment judicial proceedings. To that effect, any beneficial owner of global Notes will have the right to obtain evidence of its beneficial ownership interest in a global Note in accordance with Section 129 of the Argentine Capital Markets Law (including for initiating summary proceedings (*acción ejecutiva*) in the manner provided by the Argentine Negotiable Obligations Law), and, for such purposes, such beneficial owner will be treated as the owner of that portion of the global Note which represents its beneficial ownership interest therein. This evidence shall enable beneficial owners to institute suit before any competent court in Argentina, including summary judgment proceedings, to obtain any overdue amount under the Notes.

### **Payments of Principal and Interest**

Payment of the principal of the Notes, together with accrued and unpaid interest thereon, or payment upon redemption prior to the Stated Maturity, will be made only:

- following the surrender of the Notes at the office of the Trustee or any Paying Agent; and
- to the person in whose name the Note is registered as of the close of business, New York City time, on the due date for such payment.

Payments of interest on a Note, other than the last payment of principal and interest or payment in connection with a redemption of the Notes prior to the Stated Maturity, will be made on each payment date to the person in whose name the Note is registered at the close of business, New York City time, on the record date, which shall be the January 10 or July 10, as the case may be, preceding each such payment date.

Payments of principal and interest shall be made by depositing immediately available funds in U.S. dollars into an account maintained by the Trustee, acting on behalf of the noteholders, no later than the close of business on the Business Day prior to the applicable payment date.

Payments of principal and interest on the global notes (as defined below) will be made to The Depository Trust Company (“DTC”) or its nominee, as the case may be, as registered holder thereof. It is expected that such registered holder of global notes will receive the funds for distribution to the holders of beneficial interests in the global notes. Neither the Issuer nor the Trustee shall have any responsibility or liability for any of the records of, or payments made by, DTC or its nominee or Euroclear or Clearstream.

If any date for a payment of principal or interest or redemption is not a Business Day, the Issuer will make the payment on the next Business Day. No interest on the Notes will accrue as a result of this delay in payment.

In the case of amounts not paid by the Issuer under the Notes (after giving effect to any applicable grace period therefor), interest will continue to accrue on such amounts (except as provided below) at a rate equal to the default rate (i.e., 1.0% in excess of the interest rate then accruing on the Notes), from and including the date when such amounts were due (after giving effect to any applicable grace period therefor), and through but excluding the date of payment by the Issuer.

Subject to applicable law, the Trustee and the Paying Agent will pay to the Issuer upon request any monies held by them for the payment of principal or interest that remains unclaimed for two years. Thereafter, noteholders entitled to these monies must seek payment from the Issuer.

### **Payments of Additional Amounts**

All payments in respect of the Notes, including, without limitation, payments of principal and interest, will be made by the Issuer without withholding or deduction for or on account of any present or future taxes, duties, levies, or other governmental charges of whatever nature in effect on the Issue Date or imposed or established thereafter by or on behalf of Argentina or any political subdivision or taxing authority thereof (“Argentine Taxes”), unless the Issuer is compelled by law to deduct or withhold such Argentine Taxes. In the event of any such withholding or deduction in respect of Argentine Taxes, the Issuer will pay such additional amounts (“Additional Amounts”) as may be necessary in order that the net amounts receivable by the holders of the Notes after any withholding or deduction in respect of such Argentine Taxes shall equal the respective amounts of principal and interest which would have been

receivable in respect of the Notes in the absence of such withholding or deduction; except that no such Additional Amounts will be payable with respect to any withholding or deduction on any Notes to, or to a third party on behalf of, a holder of the Notes for or on account of: (a) any such Argentine Taxes that have been imposed by reason of the holder or beneficial owner of such Notes being a resident of Argentina or having some present or future connection with Argentina other than the mere holding of the Notes or the receipt of principal and interest in respect thereof; (b) any such Argentine Taxes that have been imposed by reason of the presentation by the holder of a Note for payment on a date more than 30 days after the date on which such payment became due and payable or the date on which payment thereof is duly provided for, whichever occurs later, except to the extent that such holder would have been entitled to such Additional Amounts on presenting such Note for payment on the last date of such period of 30 days; (c) any Argentine Taxes that would not have been imposed but for the failure of the holder or beneficial owner of such Notes to comply with any certification, information, documentation or other reporting requirements if such compliance (i) is required by applicable law, regulation, administrative practice or an applicable treaty as a precondition to exemption from, or reduction in the rate of deduction or withholding of, such Argentine Taxes, and (ii) is not more onerous to the holder or beneficial owner than comparable certification, information, documentation or other reporting requirements imposed under U.S. tax law, regulation and administrative practice (such as IRS Forms W-8 and W-9 or any comparable successor forms); (d) any estate, inheritance, gift, sales, use, value added, excise, transfer, personal assets or similar tax, assessment or other governmental charge; (e) Argentine Taxes payable otherwise than by withholding from payment of principal of, premium, if any, or interest on the Notes; (f) Argentine Taxes imposed on or on behalf of a holder or beneficial owner of a Note by reason of such person being a resident in, or having invested in the Note with funds from, a “non-cooperative jurisdiction” (as defined under the Argentine Income Tax Law and the regulations issued thereunder, and also including any jurisdiction that is listed as “non cooperative” or as a low or no-tax jurisdiction or any similar definition that the Argentine Income Tax Law or the regulations issued thereunder may include from time to time); or (g) any combination of items (a) to (f) above.

Furthermore, no Additional Amounts shall be paid with respect to (x) any payment on a Note to a holder that is a fiduciary or partnership or other than the sole beneficial owner of such payment to the extent that a beneficiary or settlor with respect to such fiduciary or a member of such partnership or beneficial owner would not have been entitled to receive the Additional Amounts had such beneficiary, settlor, member or beneficial owner been the holder or (y) any tax imposed pursuant to Sections 1471 through 1474 of the Internal Revenue Code of 1986, as amended (the “Code”) (or any amended or successor version), any current or future regulations or official interpretations thereof, any agreements entered into pursuant to Section 1471(b) of the Code and any intergovernmental agreements (and related legislation or official administrative guidance) implementing the foregoing. Any reference herein or in the Notes to principal, premium and/or interest shall be deemed also to refer to any Additional Amounts which may be payable under the undertakings described in this paragraph.

In addition, the Issuer will pay any stamp, issue, registration, documentary or other similar taxes and duties, including interest and penalties, in respect of the creation, issue and offering of the Notes, excluding any such taxes and duties imposed by any jurisdiction outside Argentina, except those resulting from, or required to be paid in connection with, the enforcement of such Notes after the occurrence and during the continuance of an Event of Default with respect to the Notes in default. The Issuer will also pay and indemnify the holders and the Trustee from and against all court taxes or other taxes and duties, including interest and penalties, paid by any of them in any jurisdiction in connection with any action permitted to be taken by the holders or the Trustee to enforce the Issuer’s obligations under the indenture and the Notes.

The Issuer will provide the Trustee with the official acknowledgement for the relevant taxing authority (or, if such acknowledgement is not available, other reasonable documentation) evidencing any payment of Argentine Taxes in respect of which the Issuer has paid any Additional Amount. Copies of such documentation will be made available to the holders upon request therefor.

In the event that the Issuer pays any personal assets tax in respect of outstanding Notes, the Issuer has agreed to waive any right it may have under Argentine law to seek reimbursement from the holders or direct owners of the Notes of any such amounts paid. See “Taxation— Certain Argentine Tax Considerations.”

## Redemption and Repurchase

### *Mandatory Redemption*

The Issuer is not required to make mandatory redemption or sinking fund payments with respect to the Notes. However, under certain circumstances, the Issuer may be required to offer to purchase the Notes as described under “Repurchase Offer upon a Change of Control Repurchase Event” or “Limitation on Asset Sales.”

### *Optional Redemption with a Make-Whole Premium*

At any time prior to July 25, 2023, the Issuer may on any one or more occasions redeem any of the Notes (including any additional Notes issued after the Issue Date) in whole or in part, at its option, at a “make-whole” redemption price equal to the greater of (A) 100% of the principal amount of such Notes and (B) the sum of the present value at such redemption date of (i) the redemption price of the Notes on July 25, 2023 and (ii) all required interest payments thereon through July 25, 2023 (excluding accrued but unpaid interest to the redemption date), in each case discounted to the redemption date on a semi-annual basis (assuming a 360-day year consisting of twelve 30-day months) at the Adjusted Treasury Rate as of such date of redemption plus 50 basis points; plus, in each case, any accrued and unpaid interest and Additional Amounts, if any, on such Notes to the redemption date.

### *Optional Redemption without a Make-Whole Premium*

At any time and from time to time on or after July 25, 2023 (the “2023 Call Date”), the Issuer may, at its option, redeem the Notes, in whole or in part, at the redemption prices, expressed as percentages of principal amount, set forth below, plus accrued and unpaid interest thereon (including Additional Amounts), if any, to, but not including, the applicable redemption date, if redeemed during the 12 month-period beginning on July 25 of the years indicated below:

<b>Year</b>	<b>Percentage</b>
2023 .....	105.000%
2024 .....	102.500%
2025 and after.....	100.000%

### *Optional Redemption with Proceeds of Equity Offerings*

At any time, or from time to time, on or prior to July 25, 2023, the Issuer may, at its option, use the net cash proceeds of one or more Equity Offerings to redeem in the aggregate up to 35% of the aggregate principal amount of outstanding Notes (including any additional Notes) at a redemption price of 110% of the principal amount thereof, plus accrued and unpaid interest (including Additional Amounts), if any, to, but not including, the redemption date; *provided that*:

- (1) Notes in an aggregate principal amount equal to at least 65% of the aggregate principal amount of Notes (including any additional Notes) remain outstanding immediately after the occurrence of such redemption; and
- (2) the redemption must occur not more than 90 days after the date of the closing of such Equity Offering.

Notice of any redemption upon an Equity Offering may be given prior to the completion thereof, and any such redemption or notice may, at the Issuer’s discretion, be subject to one or more conditions precedent, including, but not limited to, completion of the related Equity Offering.



### ***Optional Redemption for Taxation Reasons***

If, at any time subsequent to the Issue Date, as a result of any change in, or amendment to, the laws or regulations of Argentina or of any political subdivision thereof or of any authority therein or thereof having power to tax or as a result of any change in the application or official interpretation of such laws or regulations, the Issuer becomes obligated to pay any Additional Amounts as provided above under “—Payments of Additional Amounts” and the Issuer determines in good faith that such obligation cannot be avoided by taking reasonable measures available to it, then the Notes will be redeemable as a whole (but not in part), at its option, at any time at a redemption price equal to 100% of the principal amount of the Notes, plus accrued and unpaid interest (including Additional Amounts), if any, to (but not including) the redemption date. The Issuer will also pay to the holders of the Notes on the redemption date any Additional Amounts which are then payable. In order to effect a redemption of the Notes under this paragraph, the Issuer will be required to deliver to the Trustee at least 25 days prior to the redemption date (i) an Officers’ Certificate stating that the obligation to pay such Additional Amounts cannot be avoided by the Issuer taking reasonable measures available to it and (ii) an opinion of independent legal counsel of recognized standing to the effect that the Issuer has or will become obligated to pay such Additional Amounts as a result of such change or amendment. No notice of redemption pursuant to this paragraph may be given earlier than 60 days prior to the earliest date on which the Issuer would be obligated to pay such Additional Amounts were a payment in respect of the Notes then due.

### ***Procedure for Redemption***

Notice of redemption to the holders of Notes to be redeemed as a whole or in part at the Issuer’s option pursuant to the terms set forth herein shall be given to holders of the Notes as specified in “—Notices.” The notice of redemption of Notes to be redeemed at the Issuer’s option shall be given to holders of the Notes by it or, at its written request at least five Business Days prior to the date notice of redemption is deliverable to the holders of the Notes, which such request shall include all of the information required in the Indenture to be set forth in the notice of redemption, by the Trustee, in the Issuer’s name and expense, at least 10 days but not more than 60 days before the redemption date in accordance with “—Notices.” Such notice shall be irrevocable *provided* that any notice of redemption may, at the Issuer’s discretion, be subject to the satisfaction of one or more conditions precedent.

If notice of redemption has been given, the Notes to be redeemed will become due and payable on the redemption date specified in such notice *provided* that any notice of redemption may, at the Issuer’s discretion, be subject to the satisfaction of one or more conditions precedent. Upon presentation and surrender of the Notes at the place or places specified in such notice, the Notes will be paid and redeemed by the Issuer at the places and in the manner therein specified and at the redemption price therein specified. From and after the redemption date, if monies for the redemption of Notes called for redemption will have been made available at the corporate trust office of the Trustee for redemption on the redemption date, the Notes called for redemption will cease to bear interest, and the only right of the holders of such Notes will be to receive payment of the redemption price.

If fewer than all of the Notes are being redeemed, selection of the Notes for redemption will be made, to the extent permitted under applicable law and securities exchange rules, on a pro rata basis, by lot or by using any other method that the Trustee deems fair and appropriate, or otherwise in compliance with DTC procedures and requirements, in minimum denominations of US\$1,000 principal amount and integral multiples of US\$1,000 in excess thereof. In the case of certificated Notes, upon surrender of any Note redeemed in part, the holder will receive a new Note equal in principal amount to the unredeemed portion of the surrendered Note. In the case of a global note, appropriate adjustments to the amount and beneficial interests in the global note will be made as necessary.

### ***Market and Other Purchases of Notes***

The Issuer and its Subsidiaries and Affiliates may at any time purchase or otherwise acquire any Note, by purchase or private agreement, in the open market or otherwise, at any price and may resell or otherwise dispose of such Note at any time, taking into account that, in order to determine at any time whether or not the holders of the required principal amount of the outstanding Notes have made a request, demand, authorization, instruction, notice, consent or waiver, if any, the Notes held by the Issuer or any of its Subsidiaries and Affiliates will not be counted and will not be considered outstanding.

### ***Repurchase Offer upon a Change of Control Repurchase Event***

If a Change of Control Repurchase Event occurs, the Issuer will make an offer to purchase all of the Notes (a “Change of Control Offer”) *provided* that the principal amount of a holder’s Note will not be less than US\$1,000 or integral multiples of US\$1,000 in excess thereof at a purchase price in cash equal to 101% of the principal amount of the Notes, plus accrued and unpaid interest, if any, to the date of purchase (a “Change of Control Payment”).

The Issuer will give a notice of such Change of Control Offer to the holders of the Notes (with a copy to the Trustee) within 30 days following any Change of Control Repurchase Event stating:

- (i) that a Change of Control Offer is being made and that all Notes properly tendered pursuant to such Change of Control Offer will be accepted for purchase by us at a purchase price in cash equal to 101% of the principal amount of such Notes plus accrued and unpaid interest, if any, to (but excluding) the date of purchase;
- (ii) the purchase date (which shall be no earlier than 30 days nor later than 60 days from the date such notice is given) (the “Change of Control Payment Date”); and
- (iii) the procedures the Issuer determined that a holder of the Notes must follow in order to have its Notes repurchased.

On the Business Day immediately preceding the Change of Control Payment Date, the Issuer will, to the extent lawful, deposit with the Paying Agents an amount equal to the Change of Control Payment in respect of all Notes or portions of Notes so tendered.

On the Change of Control Payment Date, the Issuer will, to the extent lawful:

- (i) accept for payment all Notes or portions of Notes (of the minimum authorized denomination or permitted integral multiples in excess thereof), properly tendered and not withdrawn pursuant to the Change of Control Offer; and
- (ii) deliver or cause to be delivered to the Trustee an Officers’ Certificate stating the aggregate principal amount of Notes or portions of Notes being purchased by the Issuer.

If only a portion of a Note is purchased pursuant to a Change of Control Offer, to the extent such Notes are cancelled, a new Note in a principal amount equal to the portion thereof not purchased will be issued in the name of the holder thereof upon cancellation of the original Note (or appropriate adjustments to the amount and beneficial interests in a Note will be made, as appropriate).

The Issuer will not be required to make a Change of Control Offer upon a Change of Control Repurchase Event if a third party makes the Change of Control Offer in the manner, at the times and otherwise in compliance with the requirements applicable to a Change of Control Offer made by the Issuer and purchases all Notes validly tendered and not withdrawn under such Change of Control Offer.

In the event that holders of not less than 90% of the aggregate amount of the Notes being repurchased accept a Change of Control Offer and the Issuer (or a third party making the Change of Control Offer) purchases all of the Notes held by such holders, the Issuer will have the right to, within 30 days following the Change of Control Payment Date, redeem all of the Notes that remain outstanding following such purchase at a redemption price equal to the Change of Control Payment plus, to the extent not included in the Change of Control Payment, accrued and unpaid interest on the Notes that remain outstanding to, but excluding, the date of redemption.

The Issuer will comply, to the extent applicable, with the requirements of Rule 14e-1 under the Exchange Act and any other securities laws or regulations in connection with the repurchase of Notes pursuant to a Change of Control Offer. To the extent that the provisions of any securities laws or regulations conflict with provisions of this

offering memorandum, the Issuer will comply with the applicable securities laws and regulations and will not be deemed to have breached its obligations described in this offering memorandum by virtue of doing so.

### **Suspension of Certain Covenants**

If at any time after the Issue Date (i) the Notes are rated Investment Grade by at least two of the Rating Agencies and (ii) no Default has occurred and is continuing under the Indenture (the occurrence of the events described in the foregoing clauses (i) and (ii) being collectively referred to as a “Covenant Suspension Event”), then, beginning on that day, the Issuer and its Restricted Subsidiaries will not be subject to the covenants in the Indenture specifically listed under the following captions in this “Description of the Notes” section (the “Suspended Covenants”):

- (1) “—Certain Covenants—Limitation on Indebtedness;”
- (2) “—Certain Covenants—Limitation on Restricted Payments;”
- (3) “—Certain Covenants—Limitation on Asset Sales;” and
- (4) clause (4) of “—Certain Covenants—Mergers, Consolidations, Sales, Leases.”

During any period when the Suspended Covenants are suspended, the Issuer may not designate any Subsidiary as an Unrestricted Subsidiary.

In the event that the Issuer and its Restricted Subsidiaries are not subject to the Suspended Covenants for any period of time as a result of the foregoing, and on any subsequent date (the “Reversion Date”) the condition set forth in clause (i) of the first paragraph of this section is no longer satisfied, then the Issuer and its Restricted Subsidiaries will thereafter again be subject to the Suspended Covenants with respect to future events.

The period of time between the occurrence of a Covenant Suspension Event and the Reversion Date is referred to in this description as the “Suspension Period.” In the event of any such reinstatement, no action taken or omitted to be taken by the Issuer or any Restricted Subsidiary with respect to the Suspended Covenants during the Suspension Period will give rise to a Default or Event of Default under the Indenture with respect to the Notes. On each Reversion Date, all Indebtedness Incurred, or Disqualified Stock or Preferred Stock issued, during the Suspension Period will be classified to have been Incurred pursuant to clause (b)(7) of “—Certain Covenants—Limitation on Indebtedness.” For purposes of the “—Certain Covenants—Limitation on Asset Sales” covenant, on the Reversion Date, the amount of Excess Proceeds will be reset to the amount of Excess Proceeds in effect as of the first day of the Suspension Period ending on such Reversion Date.

Promptly following the occurrence of any Covenant Suspension Event or Reversion Date, the Issuer will provide an Officers’ Certificate to the Trustee regarding such occurrence. The Trustee shall have no obligation to independently determine or verify if a Covenant Suspension Event or Reversion Date has occurred or notify the holders of any occurrence of a Covenant Suspension Event or Reversion Date. Absent receipt of such Officers’ Certificate, the Trustee shall be entitled to assume that no Covenant Suspension Event or the occurrence of any Reversion Date has occurred. The Trustee may provide a copy of such Officers’ Certificate to any Holder of the Notes upon request.

There can be no assurance that the Notes will ever achieve or maintain a rating of Investment Grade from the Rating Agencies.

### **Certain Covenants**

The Indenture contains the following covenants:

#### ***Limitation on Indebtedness***

- (a) The Issuer:

- (1) will not, and will not permit any of its Restricted Subsidiaries to, Incur any Indebtedness; and
- (2) will not, and will not permit any of its Restricted Subsidiaries to, Incur any Disqualified Stock, and will not permit any of its Restricted Subsidiaries to Incur any Preferred Stock (other than Disqualified Stock or Preferred Stock of Restricted Subsidiaries held by the Issuer or a Restricted Subsidiary, so long as it is so held);

*provided* that the Issuer or any Restricted Subsidiary may Incur Indebtedness or Disqualified Stock and any Restricted Subsidiary may Incur Preferred Stock if on the date of the Incurrence, after giving effect to the Incurrence and the receipt and application of the proceeds therefrom, (A) the Interest Coverage Ratio is not less than 2.00 to 1.00 and (B) the Net Leverage Ratio is not greater than (i) 4.50 to 1.00 from the Issue Date until July 24, 2021, (ii) 4.00 to 1.00 from July 25, 2021 until July 24, 2022, and (iii) 3.50 to 1.00 from July 25, 2022 until the Stated Maturity of the Notes.

(b) Notwithstanding the foregoing, the Issuer and, to the extent provided below, any Restricted Subsidiary may Incur the following (“Permitted Indebtedness”):

- (1) Indebtedness of the Issuer or any Restricted Subsidiary to the Issuer or any Restricted Subsidiary so long as such Indebtedness continues to be owed to the Issuer or a Restricted Subsidiary; *provided* that
  - (i) if the Issuer is the obligor on Indebtedness owing to a Restricted Subsidiary, such Indebtedness is expressly subordinated to the prior payment in full in cash of all obligations with respect to the Notes; and
  - (ii) (A) any subsequent issuance or transfer of Capital Stock or any other event that results in any such Indebtedness being beneficially held by a Person other than the Issuer or a Restricted Subsidiary of the Issuer, and (B) any sale or other transfer of any such Indebtedness to a Person other than the Issuer or a Restricted Subsidiary of the Issuer shall be deemed, in each case, to constitute the Incurrence of such Indebtedness by the issuer thereof;
- (2) Indebtedness of the Issuer pursuant to the Notes (other than additional Notes);
- (3) Refinancing Indebtedness in respect of:
  - (A) Indebtedness (other than Indebtedness owed to the Issuer or any Restricted Subsidiary of the Issuer) Incurred pursuant to paragraph (a) above (it being understood that no Indebtedness outstanding on the Issue Date is Incurred pursuant to such paragraph (a) above), or
  - (B) Indebtedness Incurred pursuant to clauses (b)(2), (3), (6) or (7);
- (4) Hedging Agreements of the Issuer or any Restricted Subsidiary entered into in the ordinary course of business for bona fide hedging purposes and not for speculation;
- (5) Indebtedness consisting of letters of credit, bank guarantees, banker’s acceptances, warehouse receipts, or similar instruments (including in respect of workers’ compensation claims, health, disability or other employee benefits, or property, casualty or liability insurance), self-insurance obligations, customer deposits, performance, bid, surety, advance payment, appeal and similar bonds (including, for the avoidance of doubt, *seguros de caución*) and completion guarantees, in each case in the ordinary course of business and other than an obligation for borrowed money;
- (6) Acquired Indebtedness; *provided* that, after giving effect to the Incurrence thereof, either (A) the Issuer could Incur at least US\$1.00 of Indebtedness under paragraph (a) above, or (B) (x) the Interest Coverage Ratio would be higher than the Interest Coverage Ratio immediately prior to such

transaction, and (y) the Net Leverage Ratio would be lower than the Net Leverage Ratio immediately prior to such transaction;

- (7) Indebtedness of the Issuer or any Restricted Subsidiary outstanding on the Issue Date;
  - (8) Indebtedness of the Issuer or any Restricted Subsidiary, which may include Capital Leases, Incurred on or after the Issue Date and no later than 365 days after the date of purchase or completion of construction, development or improvement of property for the purpose of financing all or any part of the purchase price or cost of construction, development or improvement (including related transaction fees and expenses); *provided* that the principal amount of any Indebtedness Incurred pursuant to this clause may not exceed 5.0% of Consolidated Net Tangible Assets;
  - (9) Indebtedness arising from the honoring by a bank or other financial institution of a check, draft or similar instrument drawn against insufficient funds or Indebtedness in respect of netting services, automatic clearinghouse arrangements, overdraft protections and similar arrangements in connection with deposit accounts, in each case in the ordinary course of business;
  - (10) Guarantees by the Issuer or any Restricted Subsidiary of Indebtedness to be Incurred by the Issuer or another Restricted Subsidiary in accordance with this covenant; *provided* that, in the event such Indebtedness that is being Guaranteed is Subordinated Indebtedness, then the related Guarantee shall be subordinated in right of payment to the Notes;
  - (11) Deeply Subordinated Indebtedness;
  - (12) Indebtedness of the Issuer or any of its Restricted Subsidiaries in the form of Guarantees of Indebtedness of, or equity contribution commitments in respect of, or Indebtedness to finance equity contributions in Project Finance Subsidiaries in an aggregate principal amount not to exceed US\$100.0 million (or the equivalent in other currencies) at any time outstanding;
  - (13) Indebtedness of the Issuer or any of its Restricted Subsidiaries in an aggregate principal amount at any time outstanding not to exceed two times the aggregate net cash proceeds received by the Issuer after the Issue Date from the issuance of Qualified Equity Interests of the Issuer or any contribution to its common equity (or the equivalent in other currencies); *provided* that (i) the net proceeds from the Incurrence of such Indebtedness and the issuance of such Qualified Equity Interests of the Issuer or other contribution to its common equity are used to finance the development of power generation projects; (ii) after giving effect to such Incurrence, the Issuer is in compliance with the Interest Coverage Ratio limitation set out in paragraph (a) above; and (iii) such equity proceeds shall not be available to make Restricted Payments under clause (a)(iii)(A) or clause (b)(3) under “—Limitation on Restricted Payments” so long as such related Indebtedness under this clause (13) remains outstanding; and
  - (14) Indebtedness of the Issuer or any Restricted Subsidiary Incurred on or after the Issue Date not otherwise permitted in an aggregate principal amount at any time outstanding not to exceed 10.0% of Consolidated Net Tangible Assets.
- (c) Notwithstanding any other provision of this covenant, for purposes of determining compliance with this covenant, increases in Indebtedness solely due to fluctuations in the exchange rates of currencies will not be deemed to exceed the maximum amount that the Issuer or a Restricted Subsidiary may Incur under this covenant. For purposes of determining compliance with any U.S. dollar-denominated restriction on the Incurrence of Indebtedness, the U.S. dollar-equivalent principal amount of Indebtedness denominated in any other currency shall be calculated based on the relevant currency exchange rate in effect on the date such Indebtedness was Incurred; *provided* that, if such Indebtedness is Incurred to Refinance other Indebtedness denominated in any other currency, and such Refinancing would cause the applicable U.S. dollar-denominated restriction to be exceeded if calculated at the relevant currency exchange rate in effect on the date of such Refinancing, such U.S. dollar-denominated restriction shall be deemed not to have been exceeded so long as

the principal amount of such Refinancing Indebtedness does not exceed the principal amount of such Indebtedness being Refinanced. The principal amount of any Indebtedness Incurred to Refinance other Indebtedness, if Incurred in a different currency from the Indebtedness being Refinanced, shall be calculated based on the currency exchange rate applicable to the currencies in which such respective Indebtedness is denominated that is in effect on the date of such Refinancing.

- (d) In the event that an item of Indebtedness meets the criteria of more than one of the types of Indebtedness described in this covenant, the Issuer, in its sole discretion, will classify such item of Indebtedness and will only be required to include the amount and type of such Indebtedness in one of such clauses and the Issuer will be entitled to divide and classify an item of Indebtedness in more than one of the types of Indebtedness described in this covenant, and may change the classification of an item of Indebtedness (or any portion thereof) to any other type of Indebtedness described in this covenant at any time.
- (e) For purposes of determining compliance with, and the outstanding principal amount of, any particular Indebtedness Incurred pursuant to and in compliance with this covenant:
  - (1) the outstanding principal amount of any item of Indebtedness will be counted only once;
  - (2) the amount of Indebtedness issued at a price that is less than the principal amount thereof will be equal to the amount of the liability in respect thereof determined in accordance with IFRS;
  - (3) Guarantees of, or obligations in respect of letters of credit or similar instruments relating to, Indebtedness that is otherwise included in the determination of a particular amount of Indebtedness will not be included; and
  - (4) the accrual of interest, the accretion or amortization of original issue discount, the payment of regularly scheduled interest in the form of additional Indebtedness of the same instrument or the payment of regularly scheduled dividends on Disqualified Stock in the form of additional Disqualified Stock with the same terms will not be an Incurrence of Indebtedness for purposes of this covenant; *provided* that any such outstanding additional Indebtedness or Disqualified Stock paid in respect of Indebtedness Incurred will be counted as Indebtedness outstanding thereunder for purposes of any future Incurrence under such provision.

#### ***Limitation on Restricted Payments***

- (a) The Issuer will not, and will not permit any Restricted Subsidiary to, directly or indirectly (the payments and other actions described in the following clauses being collectively “Restricted Payments”):
  - (1) declare or pay any dividend or make any distribution (whether made in cash, securities or other property) on the Equity Interests of the Issuer or any of its Restricted Subsidiaries, other than:
    - (A) dividends or distributions payable in Qualified Equity Interests of the Issuer;
    - (B) dividends or distributions payable to the Issuer and/or any of its Restricted Subsidiaries; or
    - (C) dividends or distributions made on a *pro rata* basis to the Issuer and its Restricted Subsidiaries, on the one hand, and minority holders of Equity Interests of a Restricted Subsidiary, on the other hand (or on a less than *pro rata* basis to any minority holder);
  - (2) purchase, redeem or otherwise acquire or retire for value any Equity Interests of the Issuer or any direct or indirect parent of the Issuer held by Persons other than the Issuer or any of the Restricted Subsidiaries other than in exchange for Equity Interests of the Issuer (other than Disqualified Equity Interests);

- (3) repay, redeem, repurchase, defease or otherwise acquire or retire for value, or make any payment on or with respect to, any Subordinated Indebtedness (other than Subordinated Indebtedness of the Issuer or any Restricted Subsidiary to the extent permitted under clause (b)(1) of the definition of “Permitted Indebtedness”), except a payment of interest or principal at Stated Maturity; or
- (4) make any Investment other than a Permitted Investment;

unless, at the time of, and after giving effect to, the proposed Restricted Payment:

- (i) no Default has occurred and is continuing;
- (ii) the Issuer could Incur at least US\$1.00 of Indebtedness under paragraph (a) under “— Limitation on Indebtedness”; and
- (iii) the aggregate amount expended for all Restricted Payments made on or after the Issue Date (other than pursuant to clause (5) of paragraph (b)) would not, subject to paragraph (c), exceed the sum of:
  - (A) subject to paragraph (c), the aggregate net cash proceeds received by the Issuer (other than from a Subsidiary) after the Issue Date from:
    - (i) the issuance and sale of Qualified Equity Interests of the Issuer, including by way of issuance of its Disqualified Equity Interests or Indebtedness to the extent subsequently converted into or exchanged for Qualified Equity Interests of the Issuer, or
    - (ii) any contribution to its common equity, plus
  - (B) an amount equal to the sum, for all Unrestricted Subsidiaries, of the following:
    - (i) the cash return, after the Issue Date, on Investments in an Unrestricted Subsidiary made after the Issue Date pursuant to this paragraph (a) as a result of any sale for cash, repayment, redemption, liquidating distribution or other cash realization (not included in Consolidated Net Income), plus
    - (ii) the portion (proportionate to the Issuer’s equity interest in such Unrestricted Subsidiary) of the fair market value of the assets less liabilities of an Unrestricted Subsidiary at the time such Unrestricted Subsidiary is designated a Restricted Subsidiary, not to exceed, in the case of any Unrestricted Subsidiary, the amount of Investments made after the Issue Date by the Issuer and its Restricted Subsidiaries in such Unrestricted Subsidiary pursuant to this paragraph (a), plus
  - (C) the cash return, after the Issue Date, on any other Investment made after the Issue Date pursuant to this paragraph (a), as a result of any sale for cash, repayment, redemption, liquidating distribution or other cash realization (not included in Consolidated Net Income), not to exceed the amount of such Investment so made.

The amount expended in any Restricted Payment, if other than in cash, will be deemed to be the fair market value of the relevant non-cash assets, as determined in good faith by the Board of Directors of the Issuer whose determination will be conclusive and evidenced by a Board Resolution of the Issuer.

- (b) The foregoing will not prohibit:
- (1) the payment of any dividend within 60 days after the date of declaration thereof if, at the date of declaration, such payment would comply with the provisions of this covenant;
  - (2) the repayment, redemption, repurchase, defeasance or other acquisition or retirement for value of Subordinated Indebtedness with the proceeds of, or in exchange for, Refinancing Indebtedness;
  - (3) (i) the purchase, redemption or other acquisition or retirement for value of Equity Interests of the Issuer, (ii) the repayment, redemption, repurchase, defeasance or other acquisition or retirement of Subordinated Indebtedness of the Issuer or (iii) any Investment, in each case made in exchange for, or out of the proceeds of a substantially concurrent offering or placement of, Qualified Equity Interests of the Issuer or any Affiliate of the Issuer (to the extent contributed to the Capital Stock of the Issuer in the form of Qualified Equity Interests);
  - (4) the repayment, redemption, repurchase, defeasance or other acquisition or retirement for value of any Subordinated Indebtedness at a purchase price not greater than (x) 101% of the principal amount thereof in the event of a change of control pursuant to a provision no more favorable to the holders thereof than “—Repurchase Offer upon a Change of Control Repurchase Event” or (y) 100% of the principal amount thereof in the event of an asset sale pursuant to a provision no more favorable to the holders thereof than “—Limitation on Asset Sales,” *provided* that, in each case, the Issuer has complied or is simultaneously complying with “—Repurchase Offer upon a Change of Control Repurchase Event” and “—Limitation on Asset Sales,” as applicable; or
  - (5) dividends or distributions on the Equity Interests of the Issuer in an amount not to exceed 100% of the aggregate amount of the Consolidated Net Income accrued during the fiscal year immediately prior to the date of such dividend or distribution; *provided* that at the time of, and after giving effect to, such proposed dividend or distribution, the Issuer could Incur at least US\$1.00 of Indebtedness under paragraph (a) under “— Limitation on Indebtedness”; or
  - (6) Restricted Payments not otherwise permitted (other than dividends or distributions on the Equity Interests of the Issuer or any of its Restricted Subsidiaries) in an aggregate amount not to exceed the greater of (i) US\$100 million (or the equivalent in other currencies) and (ii) 10.0% of Consolidated Net Tangible Assets;

*provided* that, in the case of clauses (3), (4) and (5), no Default has occurred and is continuing or would occur as a result thereof.

- (c) Proceeds of the issuance of Qualified Equity Interests will be included under clause (a)(iii)(A) of this covenant only to the extent they are not applied as described in clause (3) of paragraph (b). Restricted Payments permitted pursuant to clause (2) or (3) of paragraph (b) will not be included in making the calculations under clause (a)(iii)(A) of this covenant. The use of proceeds from the issuance of Qualified Equity Interests or contributions to common equity on the clauses (a)(iii)(A) and (b)(3) will be subject to the limitations set forth under clause (b)(13) under “—Limitation on Indebtedness.”
- (d) For purposes of determining compliance with this covenant, in the event that a Restricted Payment permitted pursuant to this covenant or a Permitted Investment meets the criteria of more than one of the categories of Restricted Payment described in clauses (1), (2), (3), (4) and (6) of paragraph (b) above or one or more clauses of the definition of Permitted Investments, as the case may be, the Issuer shall be permitted to classify such Restricted Payment or Permitted Investment on the date it is made, or later reclassify all or a portion of such Restricted Payment or Permitted Investment, in any manner that complies with this covenant, and such Restricted Payment or Permitted Investment shall be treated as having been made pursuant to only one of such clauses of this covenant or of the definition of Permitted Investments, as the case may be. For purposes of covenant compliance, the amount of any Investment shall be the amount actually invested, without adjustment for subsequent increases or decreases in the value of such Investment,



less any amount paid, repaid, returned, distributed or otherwise received in cash in respect of such Investment.

### ***Limitations on Liens***

The Issuer will not, and will not permit any of its Restricted Subsidiaries to, directly or indirectly, create, incur, assume or suffer to exist any Lien on any of its or its Restricted Subsidiaries present or future property to secure Indebtedness unless, at the same time or prior thereto, all of the Notes are equally and ratably secured therewith, except for (“Permitted Liens”):

- (a) any Lien existing on the date of the Issue Date;
- (b) Liens in favor of issuers of surety or performance bonds or letters of credit or bankers’ acceptances or similar obligations issued pursuant to the request of and for the account of such Person in the ordinary course of its business;
- (c) any landlord’s, workmen’s, carriers’, warehousemen’s, mechanics’, materialmen’s, repairmen’s or other like Liens arising in the ordinary course of business (excluding, for the avoidance of doubt, Liens in connection with any Indebtedness for borrowed money) that are not overdue for a period of more than 30 days or that are being contested in good faith by appropriate proceedings; *provided that* any reserve or other appropriate provision required in conformity with IFRS has been made therefor;
- (d) any Lien on any property (including Capital Stock of any Person) securing Indebtedness incurred or assumed solely for the purpose of financing or refinancing all or any part of the cost of acquisition, construction, development or improvement of such property (including related transaction fees and expenses), which Lien attached to such property concurrently with or within 365 days after the acquisition or the completion of the construction, development or improvement thereof;
- (e) any Lien on any property or Capital Stock existing thereon at the time of acquisition of such property or Capital Stock, including by means of merger or otherwise, and not created in connection with such acquisition; *provided that* any such Lien may not extend to any other property owned by the Issuer or any of its Restricted Subsidiaries;
- (f) Liens securing the Notes or any of the Issuer’s other securities for the purposes of defeasance thereof in accordance with the terms of the Indenture or any indenture under which such other securities have been issued;
- (g) pledges or deposits under worker’s compensation laws, unemployment insurance laws or similar legislation, or good faith deposits in connection with bids, tenders, contracts or leases, or to secure public or statutory obligations, surety bonds, customs duties and the like, or for the payment of rent, in each case incurred in the ordinary course of business and not securing Indebtedness;
- (h) Liens in respect of taxes and other governmental assessments and charges which are not yet due or which are being contested in good faith and by appropriate proceedings;
- (i) minor survey exceptions, minor encumbrances, easements or reservations of, or rights of others for, licenses, rights of way, sewers, electric lines, telegraph and telephone lines and other similar purposes, or zoning or other restrictions as to the use of real property, not interfering in any material respect with the conduct of the business of the Issuer and the Restricted Subsidiaries;
- (j) licenses or leases or subleases as licensor, lessor or sublessor of any of its property, including intellectual property, in the ordinary course of business;
- (k) judgment liens, so long as no Event of Default then exists as a result thereof;

(l) Liens securing Hedging Agreements so long as such Hedging Agreements relate to Indebtedness for borrowed money that is, and is permitted to be under the Indenture, secured by a Lien on the same property securing such Hedging Agreements;

(m) Liens on property or shares of stock of a Person at the time such Person becomes a Restricted Subsidiary of the Issuer; *provided* such Liens were not created in contemplation thereof and do not extend to any other property of the Issuer or any Restricted Subsidiary;

(n) any pledge of the Capital Stock of an Unrestricted Subsidiary to secure Indebtedness of such Unrestricted Subsidiary;

(o) any Lien on any property securing an extension, renewal or refunding of Refinanced Indebtedness secured by a Lien referred to in (a), (b), (d), (e), (m) and (o) above, *provided* that such new Lien is limited to the property which was subject to the prior Lien immediately before such extension, renewal or refunding and *provided, further*, that the principal amount of Indebtedness secured by the prior Lien immediately before such extension, renewal or refunding is not increased (other than in respect of transaction fees and expenses);

(p) any other Lien on the Issuer's properties or those of any of its Restricted Subsidiaries not permitted by any other provision in this Section, *provided* that, on the date of creation or assumption of such Lien, the Indebtedness secured thereby, together with all the Issuer's and its Restricted Subsidiaries' other Indebtedness secured by any Lien in reliance on this clause (p), has an aggregate outstanding amount no greater than 15.0% of the Issuer's Consolidated Net Tangible Assets.

#### ***Limitation on Asset Sales***

The Issuer will not, and will not permit any Restricted Subsidiary to, make any Asset Sale unless the following conditions are met:

(1) the Issuer (or such Restricted Subsidiary, as the case may be) receives consideration at the time of such Asset Sale at least equal to the fair market value of the assets or Equity Interests issued or sold or otherwise disposed of, as determined in good faith by the Board of Directors of the Issuer; and

(2) at least 75% of the consideration consists of cash or Cash Equivalents or Additional Assets or any combination of the foregoing received at closing. For purposes of this clause (2), each of the following will be deemed to be cash:

(A) any liabilities of the Issuer or such Restricted Subsidiary (other than Subordinated Indebtedness) that are assumed by the transferee of any such assets pursuant to a customary novation agreement or other arrangement that releases the Issuer or such Restricted Subsidiary from further liability; and

(B) any securities, notes or other obligations received by the Issuer or such Restricted Subsidiary from such transferee that are, within 180 days after the consummation of the Asset Sale, converted by the Issuer or such Restricted Subsidiary into cash or Cash Equivalents, but only to the extent of the cash or Cash Equivalents actually received in that conversion;

(3) within 365 days after the receipt of any Net Cash Proceeds from an Asset Sale, the Net Cash Proceeds may be used:

(A) to repay Indebtedness (other than any Disqualified Equity Interests or Subordinated Indebtedness) of the Issuer or a Restricted Subsidiary (and, in the case of a revolving credit, permanently reduce the commitment thereunder by such amount), in each case owing to a Person other than the Issuer or any Restricted Subsidiary,

- (B) to invest in or purchase Additional Assets, or
  - (C) any combination of items (A) or (B) of this paragraph; and
- (4) the Net Cash Proceeds of an Asset Sale not applied pursuant to clause (3) within 365 days of the Asset Sale constitute “Excess Proceeds.” Excess Proceeds of less than US\$20.0 million (or the equivalent in other currencies) will be carried forward and accumulated. When accumulated Excess Proceeds equal or exceed such amount, the Issuer must, within 30 days, make an offer to purchase (the “Asset Sale Offer”) Notes having a principal amount equal to:
- (A) accumulated Excess Proceeds, multiplied by
  - (B) a fraction (x) the numerator of which is equal to the outstanding principal amount of the Notes and (y) the denominator of which is equal to the outstanding principal amount of the Notes and all *pari passu* Indebtedness similarly required to be repaid, redeemed or tendered in connection with the Asset Sale, rounded down to the nearest US\$1,000. The purchase price (the “Asset Sale Payment”) for the Notes will be 100% of the principal amount plus accrued and unpaid interest to, but excluding, the date of purchase;

*provided*, that, in the case of clause (3), a binding commitment to invest in or purchase Additional Assets shall be treated as a permitted application of the Net Cash Proceeds from the date of such commitment so long as the Issuer or a Restricted Subsidiary enters into such commitment with the good faith expectation that such Net Cash Proceeds will be applied to satisfy such commitment within 365 days of such commitment (an “Acceptable Commitment”) and such Net Cash Proceeds is actually applied in such manner within the later of 365 days from the consummation of the Asset Sale and 365 days from the date of the Acceptable Commitment.

Each notice of an Asset Sale Offer shall be given to each registered holder of the Notes, with a copy to the Trustee, as described in “—Notices” below. The Asset Sale Offer will state, among other things, the purchase date, which must not be less than 30 days or more than 60 days from the date the notice is given, other than as may be required by law (the “Asset Sale Payment Date”). The Asset Sale Offer will also contain instructions and materials necessary to enable holders to tender Notes pursuant to the offer.

On the Business Day immediately preceding the Asset Sale Payment Date, the Issuer will, to the extent lawful, deposit with the paying agent funds in an amount equal to the Asset Sale Payment in respect of all Notes or portions thereof so tendered.

On the Asset Sale Payment Date, the Issuer will, to the extent lawful:

- (1) accept for payment all Notes or portions thereof properly tendered and not withdrawn pursuant to the Asset Sale Offer; and
- (2) deliver or cause to be delivered to the Trustee the Notes so accepted, together with an Officer’s Certificate stating the aggregate principal amount of the Notes or portions thereof being purchased by the Issuer.

If the Asset Sale Offer is for less than all of the outstanding Notes and Notes in an aggregate principal amount in excess of the purchase amount are tendered and not withdrawn pursuant to the offer, the Issuer will purchase Notes having an aggregate principal amount equal to the purchase amount on a *pro rata* basis, with adjustments so that only Notes in multiples of US\$1,000 principal amount will be purchased, *provided* that the principal amount of such tendering holder’s Note will not be less than US\$1,000. Upon completion of the Asset Sale Offer, Excess Proceeds will be reset at zero, and any Excess Proceeds remaining after consummation of the Asset Sale Offer may be used for any purpose not otherwise prohibited by the Indenture.

The Issuer will comply with Rule 14e-1 under the Exchange Act and any other applicable securities laws and regulations in connection with the purchase of Notes through an Asset Sale Offer, and the above procedures will be deemed modified as necessary to permit such compliance.

If at any time any non-cash consideration received by the Issuer or any Restricted Subsidiary, as the case may be, in connection with any Asset Sale is converted into or sold or otherwise disposed of for cash (other than interest received with respect to any non-cash consideration), the conversion or disposition will be deemed to constitute an Asset Sale hereunder and the net cash proceeds thereof will be applied in accordance with this covenant within 365 days of conversion or disposition.

The Issuer will not be required to make an Asset Sale Offer following an Asset Sale if a Restricted Subsidiary or a third party makes the Asset Sale Offer in the manner, at the times and otherwise in compliance with the requirements set forth in the Indenture applicable to an Asset Sale Offer following an Asset Sale made by the Issuer and if such Person purchases all Notes validly tendered and not withdrawn under such Asset Sale Offer.

### ***Designation of Restricted and Unrestricted Subsidiaries***

- (a) The Board of Directors of the Issuer may designate after the Issue Date any Subsidiary, including a newly acquired or created Subsidiary, to be an Unrestricted Subsidiary if it meets the following qualifications:
- (1) such Subsidiary does not own any Capital Stock of the Issuer or any Restricted Subsidiary or hold any Indebtedness of, or any Lien on any property of, the Issuer or any Restricted Subsidiary;
  - (2) at the time of the designation, the designation would be permitted under “— Limitation on Restricted Payments” (assuming the effectiveness of such designation and treating such designation as an Investment at the time of designation);
  - (3) to the extent the Indebtedness of the Subsidiary is not Non-Recourse Indebtedness, any Guarantee or other credit support thereof by the Issuer or any Restricted Subsidiary is permitted under “— Limitation on Indebtedness” and “—Limitation on Restricted Payments;”
  - (4) neither the Issuer nor any Restricted Subsidiary has any obligation to subscribe for additional Equity Interests of the Subsidiary or to maintain or preserve its financial condition or cause it to achieve specified levels of operating results, except to the extent permitted by “—Limitation on Indebtedness” and “—Limitation on Restricted Payments”;
  - (5) no Default or Event of Default has occurred and is continuing at the time or after giving effect to such designation;
  - (6) such Subsidiary is not a Significant Subsidiary at the time of its designation; and
  - (7) once so designated, the Subsidiary will remain an Unrestricted Subsidiary, subject to paragraph (b).
- (b)
- (1) A Subsidiary previously designated an Unrestricted Subsidiary which fails to meet the qualifications set forth in paragraph (a) will be deemed to become at that time a Restricted Subsidiary, subject to the consequences set forth in paragraph (d).
  - (2) The Board of Directors of the Issuer may designate an Unrestricted Subsidiary to be a Restricted Subsidiary if, at the time of such designation, no Default or Event of Default has occurred and is continuing and such designation would not cause a Default.
- (c) Upon a Restricted Subsidiary becoming an Unrestricted Subsidiary:

- (1) all existing Investments of the Issuer and the other Restricted Subsidiaries therein (valued at the Issuer's and other Restricted Subsidiaries' proportional share of the fair market value of its assets less liabilities) will be deemed to have been made at that time;
  - (2) all existing Capital Stock or Indebtedness of, and all Liens on property of, the Issuer or any other Restricted Subsidiary held by it will be deemed Incurred at that time;
  - (3) all existing transactions between it and the Issuer or any other Restricted Subsidiary will be deemed to have been entered into at that time; and
  - (4) it will cease to be subject to the provisions of the Indenture as a Restricted Subsidiary.
- (d) Upon an Unrestricted Subsidiary becoming, or being deemed to become, a Restricted Subsidiary:
- (1) all of its Indebtedness and Disqualified Stock or Preferred Stock will be deemed Incurred at that time for purposes of "—Limitation on Indebtedness;"
  - (2) Investments therein previously charged under "—Limitation on Restricted Payments" will be credited thereunder; and
  - (3) it will thenceforward be subject to the provisions of the Indenture as a Restricted Subsidiary.
- (e) Any designation by the Board of Directors of the Issuer of a Subsidiary as a Restricted Subsidiary or Unrestricted Subsidiary will be evidenced to the Trustee by promptly delivering to the Trustee a copy of the Board Resolution of the Issuer giving effect to the designation and an Officers' Certificate certifying that the designation complied with the foregoing provisions.
- (f) The designation of a Subsidiary of the Issuer as an Unrestricted Subsidiary will be deemed to include the designation of all of the Subsidiaries of such Subsidiary, unless otherwise determined by the Board of Directors of the Issuer.

***Mergers, Consolidations, Sales, Leases***

The Issuer will not merge or consolidate with or into, or convey, transfer or lease its Properties substantially as an entirety or substantially an entirety (determined on a consolidated basis for the Issuer and its Restricted Subsidiaries), whether in one transaction or a series of transactions, to any Person, unless immediately after giving effect to such transaction,

- (1) no Default or Event of Default shall have occurred and be continuing;
- (2) either (a) the Issuer is the continuing Person or (b) any Person formed by any such merger or consolidation or the Person which acquires by conveyance or transfer, or which leases such properties and assets (other than the Issuer) (the "Successor Person") is a corporation organized and validly existing under the laws of Argentina, the United States of America, any state thereof or the District of Columbia or any member country of the Organization for Economic Cooperation and Development and expressly assumes, by a supplemental indenture, executed and delivered to the Trustee, in form reasonably satisfactory to the Trustee, the due and punctual payment of principal, interest and premium, if any, and Additional Amounts, if any, that may result due to withholding by any jurisdiction in which such Successor Person is organized or any political subdivision or taxing authority thereof (and, for purposes of the payment of Additional Amounts, references in "— Payments of Additional Amounts" to Argentina or Argentine Taxes shall be deemed also to include such jurisdiction and taxes imposed thereby), on all of the Notes according to their terms, and the due and punctual performance of all of the Issuer's other covenants and obligations under the Indenture and Notes;

- (3) the Successor Person (except in the case of leases), if any, succeeds to and becomes substituted for us with the same effect as if it had been named in the Notes and the Indenture as the Issuer;
- (4) immediately after giving effect to the transaction on a pro forma basis, either (x) the Issuer or the Successor Person could Incur at least US\$1.00 of Indebtedness under paragraph (a) under “—Limitation on Indebtedness”, or (y) the Interest Coverage Ratio and the Net Leverage Ratio of the Issuer or the Successor Person is better than the Interest Coverage Ratio and the Net Leverage Ratio, as the case may be, of the Issuer without giving effect to the transaction; and
- (5) the Issuer shall have delivered to the Trustee an Officers’ Certificate and an opinion of counsel each stating that all conditions precedent to such merger, consolidation, conveyance, or transfer and the execution of such supplemental indenture (if any) have been satisfied and such merger, consolidation, conveyance, or transfer and the execution of such supplemental indenture (if any) is authorized or permitted by the Indenture;

*provided* that clauses (1), (2), (4) and (5) do not apply to (a) the consolidation, amalgamation or merger of the Issuer with or into a Restricted Subsidiary or (b) the consolidation, amalgamation or merger of a Restricted Subsidiary with or into the Issuer.

### ***Reporting***

For so long as any of the Notes remain outstanding and constitute “restricted securities” within the meaning of Rule 144(a)(3) under the Securities Act, the Issuer will furnish to the holders of the Notes and prospective investors, upon their request, the information required to be delivered pursuant to Rule 144A(d)(4) under the Securities Act.

The Issuer will furnish to the Trustee: (A) as soon as available, but, in any event within 90 days after the end of each of the first three quarters of each fiscal year, unaudited consolidated financial statements for such quarter in English prepared in accordance with IFRS and (B) as soon as available but, in any event, within 120 days after the end of each fiscal year, (1) audited consolidated financial statements in English prepared in accordance with IFRS for such fiscal year, and (2) an Officers’ Certificate certifying that, since the Issuer’s most recent delivery of financial statements pursuant to this section, no default or Event of Default has occurred or is continuing or, if such default or Event of Default has occurred and is continuing, specifying its nature, the period of its existence and the action taken or proposed to be taken to remedy such default or Event of Default.

The Issuer will be deemed to have complied with the foregoing paragraphs if it has posted the required information on its website within the time periods described above.

The Trustee shall not be responsible or liable for determining or monitoring whether or not the Issuer has delivered (or otherwise made available on its website) any report or other information in accordance with the requirements specified in the foregoing paragraphs.

Delivery of any of the reports, information and documents to the Trustee (other than the Officers’ Certificate deliverable pursuant to (B)(2) mentioned in the second paragraph of this section) is for informational purposes only, and the Trustee’s receipt of such reports shall not constitute actual or constructive notice of any information contained therein or determinable from information contained therein, including the Issuer’s compliance with any covenants under the Indenture or the Notes (as to which the Trustee is entitled to conclusively rely on Officers’ Certificates).

### ***Payment of Principal and Interest***

The Issuer will duly and punctually pay the principal of and interest and premium and Additional Amounts, if any, on the Notes in accordance with the terms of the Notes and the Indenture.

### ***Maintenance of Office or Agency***

The Issuer will maintain in each of the City of Buenos Aires, New York and Luxembourg, an office or agency (including for such purposes the office of a Paying Agent or Transfer Agent, to the extent applicable) where the Notes may be presented or surrendered for payment.

### ***Maintenance of Existence***

The Issuer will maintain its corporate existence and take all reasonable actions to maintain all rights, privileges and the like necessary or desirable in the normal conduct of business, activities or operations; *provided* that this covenant shall not prohibit any transaction otherwise permitted under the covenant described in “—Mergers, Consolidations, Sales, Leases.”

### ***Maintenance of Books and Records***

The Issuer will, and will cause each of its Subsidiaries to, maintain books, accounts and records in accordance with IFRS.

### ***Notice of Default***

The Issuer will give written notice to the holders of the Notes and the Trustee promptly, and in any event within 30 days after the Issuer becomes aware thereof, of the occurrence and continuance of any Event of Default, accompanied by an Officers’ Certificate, if applicable, setting forth the details of such Event of Default and stating what action the Issuer proposes to take with respect thereto.

### ***Further Actions***

The Issuer will use its commercially reasonable efforts to take any action, satisfy any condition or do anything (including the obtaining or effecting of any necessary consent, approval, authorization, exemption, filing, license, order, recording or registration) at any time required in accordance with the applicable laws and regulations to be taken, fulfilled or done in order (a) to enable the Issuer lawfully to enter into, exercise its rights and perform and comply with its payment obligations under the Notes, as the case may be, (b) to ensure that those obligations are legally binding and enforceable, and (c) to make the Notes admissible in evidence in the courts of Argentina.

### **Events of Default**

So long as any of the Notes remain outstanding, if any of the following events (each an “Event of Default”) with respect to the Notes shall occur and be continuing:

- (i) default by the Issuer in the payment of any principal or premium due on the Notes and such default continues for a period of 7 days; or
- (ii) default by the Issuer in the payment of any interest or any Additional Amounts due on any Note and such default continues for a period of 30 days; or
- (iii) default in the performance or observance by the Issuer of any other term, covenant or obligation under the Notes or the Indenture not otherwise described in subparagraphs (i) or (ii) above, for a period of more than 45 days after there has been given to the Issuer by the Trustee or by holders of not less than 25% in aggregate principal amount of the outstanding Notes (with a copy to the Trustee if given by the holders) a written notice specifying such default and requiring it to be remedied; or
- (iv) the Issuer or any of its Restricted Subsidiaries shall (a) default in the payment of principal or interest on Indebtedness in an aggregate principal amount equal to or in excess of US\$30.0 million (or the then-equivalent thereof), other than the Notes, when and as such Indebtedness shall become due and payable, if such default continues for more than the period of grace, if any, originally applicable thereto and

the time for payment of such amount has not been expressly extended or (b) default in the observance of any other terms and conditions relating to Indebtedness in an aggregate principal amount equal to or in excess of US\$30.0 million (or the then-equivalent thereof), other than the Notes, if the effect of such default is to cause the aggregate principal amount of such Indebtedness to become due prior to its Stated Maturity; or

(v) one or more final and non-appealable judgments or orders for the payment of money are rendered against the Issuer or any of its Restricted Subsidiaries and are not paid or discharged (and are not covered by adequate insurance by a solvent insurer of national or international reputation that has acknowledged its obligations in writing), and there is a period of 45 days following entry of the final and non-appealable judgment or order (or 45 days, in the event that an enforcement proceeding is commenced upon the entry of such judgment or order) that causes the aggregate amount for all such final and non-appealable judgments or orders outstanding and not paid or discharged against all such Persons to exceed US\$30.0 million (or the equivalent in other currencies) during which a stay of enforcement, by reason of a pending appeal or otherwise, is not in effect; or

(vi) it becomes unlawful for the Issuer to perform any of its payment obligations under the Notes, or any of its payment obligations thereunder ceases to be valid, binding or enforceable; or

(vii) a resolution is passed or adopted by the Issuer's Board of Directors or shareholders, or a ruling or judgment of a Government Agency having jurisdiction or a court of competent jurisdiction is made, that the Issuer be wound up or dissolved, other than pursuant to a merger, consolidation or other transaction otherwise permitted in accordance with the terms of Indenture as described in "— Mergers, Consolidations, Sales and Leases," and, in the case of any such ruling or judgment, remains undismissed for 45 days consecutive days; or

(viii) a court having jurisdiction enters a decree or order for (a) relief in respect of the Issuer or any of its Significant Subsidiaries in an involuntary case under Argentine Law No. 24,522, as amended (the "Bankruptcy Law"), or any other applicable bankruptcy, insolvency or other similar law now or hereafter in effect or (b) appointment of an administrator, receiver, trustee or intervenor for the Issuer or any of its Significant Subsidiaries for all or substantially all of the Issuer or any of its Significant Subsidiaries' property and, in each case, such decree or order remains unstayed and in effect for a period of 45 consecutive days; or

(ix) the Issuer or any of its Significant Subsidiaries (a) commence a voluntary case under the Bankruptcy Law or any other applicable bankruptcy, insolvency or other similar law now or hereafter in effect including, without limitation, any out-of-court agreement (*acuerdo preventivo extrajudicial*), (b) consent to the appointment of or taking possession by an administrator, receiver, trustee or intervenor for the Issuer or any of its Significant Subsidiaries for all or substantially all of the Issuer or any of its Significant Subsidiaries' Properties or (c) effect any general assignment for the benefit of creditors; or

(x) a moratorium is agreed or declared in respect of any of the Issuer or any of its Significant Subsidiary's Indebtedness; or

(xi) any event occurs which under the laws of any relevant jurisdiction has an analogous effect to any of the events referred to in subparagraph (viii) or (ix) above and, in the case of (viii), such analogous event remains unstayed and in effect for a period of 45 consecutive days;

then, if such an Event of Default (other than an Event of Default specified in subparagraphs (viii), (ix), (x) or (xi) above) occurs and is continuing with respect to the Notes, the Trustee or the holders of not less than 25% in aggregate principal amount of the outstanding Notes may declare the principal amount of all the Notes to be due and payable immediately, by a notice in writing to the Issuer (and to the Trustee if given by the holders), and upon any such declaration such principal amount and any accrued interest and Additional Amounts shall become immediately due and payable. If an Event of Default specified in subparagraphs (viii), (ix), (x) or (xi) above occurs, the principal and any accrued interest and Additional Amounts on all the Notes then outstanding shall become immediately due and payable without any action by the Trustee or any holder; *provided* that after such acceleration, an affirmative vote of the holders of not less than 66% in aggregate principal amount of the Notes at the time outstanding present or



represented at a meeting of such holders at which a quorum is present may rescind and cancel such declaration and its consequences:

- (i) if the rescission would not conflict with any judgment or decree;
- (ii) if all existing Events of Default have been cured or waived, except nonpayment of principal or interest that has become due solely because of such declaration of acceleration; and
- (iii) if the Issuer has paid the Trustee its reasonable compensation and reimbursed the Trustee for its reasonable expenses, disbursements and advances (including legal fees and expenses) in accordance with the Indenture.

No rescission shall affect any subsequent Default or impair any rights relating thereto.

### **Listing**

The Issuer has applied to have the Notes listed on the Luxembourg Stock Exchange for trading on the Euro MTF Market. The Issuer has also applied to have the Notes admitted for trading on the MAE. If the admission of the Notes to the Luxembourg Stock Exchange and trading on the Euro MTF Market of the Luxembourg Stock Exchange would, in the future, require it to publish financial information either more regularly than it would otherwise be required to, or requires the Issuer to publish separate financial information, or if the listing, in the Issuer's judgment, is unduly burdensome, the Issuer may seek an alternative admission to listing, trading and/or quotation for the Notes by another listing authority, stock exchange and/or quotation system. If such alternative admission to listing, trading and/or quotation of the Notes is not available to the Issuer or is, in its commercially reasonable judgment, unduly burdensome, an alternative admission to listing, trading and/or quotation of the Notes may not be obtained.

### **Meetings, Modification and Waiver**

The Issuer and the Trustee may, without the vote or consent of any holder of Notes, modify or amend the Indenture or the Notes for the purpose of:

- adding to the Issuer's covenants such further covenants, restrictions, conditions or provisions as are for the benefit of the holders of such Notes;
- surrendering any right or power conferred upon the Issuer;
- securing the Notes pursuant to the requirements thereof or otherwise;
- evidencing the succession of another person to the Issuer and the assumption by any such successor of its covenants and obligations in the Notes and in the Indenture pursuant to any merger, consolidation or sale of assets;
- complying with any requirement of the CNV in order to effect and maintain the qualification of the Indenture;
- making any modification which is of a minor or technical nature or correcting or supplementing any ambiguous, inconsistent or defective provision contained in the Indenture or in such Notes, to the extent such modification, correction or supplement does not adversely affect the interest of the holders of the Notes in any material respect;
- conforming any provisions of the Indenture or the Notes to this "Description of the Notes."
- making any other modification, or granting any waiver or authorization of any breach or proposed breach, of any of the terms and conditions of such Notes or any other provisions of the Indenture in any manner which does not adversely affect the interest of the holders of the Notes in any material respect;

- appointing a successor trustee in accordance with the terms of the Indenture;
- establishing the form or terms of any Additional Notes as permitted under the Indenture; or
- making modifications or amendments in order to increase the size of the Issuer's global rate program.

Modifications to and amendments of the Indenture and the Notes may be made, and future compliance or past default by the Issuer may be waived, by the Issuer and the Trustee, if any, by the adoption of a resolution at a meeting of holders of the Notes as set forth below, but no such modification or amendment and no such waiver may, without the unanimous consent of the holders of all Notes adversely affected thereby,

- extend the due date for the payment of principal of, premium, if any, or any installment of interest on any such Note;
- reduce the principal amount of, the portion of such principal amount which is payable upon acceleration of the maturity of, the rate of interest on or the premium payable upon redemption or repurchase of any such Note;
- reduce the Issuer's obligation to pay Additional Amounts on any such Note;
- shorten the period during which the Issuer is not permitted to redeem any such Note, or permit the Issuer to redeem any such Note if, prior to such action, the Issuer is not permitted to do so;
- change the currency in which or the required places at which any such Note or the premium or interest thereon is payable;
- reduce the percentage of the aggregate principal amount of such Notes necessary to modify, amend or supplement the Indenture or such Notes, or for waiver of compliance with certain provisions thereof or for waiver of certain defaults;
- reduce the percentage of aggregate principal amount of outstanding Notes required for the adoption of a resolution or the quorum required at any meeting of holders of such Notes at which a resolution is adopted;
- modify any provisions of the Indenture relating to meetings, modifications or waivers as described above, except to increase any such percentage or to provide that certain other provisions of the Indenture cannot be modified or waived without the consent of the holder of each Note adversely affected thereby; or
- impair the right to sue for enforcement of any payment in respect of any such Notes.

A meeting of the holders of Notes may be called by the Issuer's Board of Directors or Supervisory Committee, the Trustee or upon the request of the holders of at least 5% in principal amount of the outstanding Notes. If a meeting is held pursuant to the written request of holders of Notes, such meeting will be convened within 40 days from the date such written request is received by the Issuer.

Meetings may be ordinary meetings or extraordinary meetings. Any proposed amendment to the terms and conditions of the Notes requiring the consent of the holders of the Notes shall be dealt with at an extraordinary meeting. Any such meeting may, as determined by the Issuer or the Trustee, be held simultaneously in the City of Buenos Aires and New York City by means of telecommunications which permit the participants to hear and speak to each other. Notice of any meeting of holders of Notes (which will include the date, place and time of the meeting, the agenda therefor and the requirements for attendance) will be given as set forth under "—Notices" not less than 10 nor more than 30 days prior to the date fixed for the meeting and, to the extent required by applicable law, will be published at the Issuer's expense for five business days in Argentina in the Official Gazette of Argentina (Boletín Oficial), in a

newspaper of general circulation and in the Bulletin of the MAE (as long as the Notes are listed on the MAE). Meetings of holders may be simultaneously convened for two dates, in case the initial meeting were to be adjourned for lack of quorum. However, for meetings that include in the agenda items requiring consent of each holder of a Note or the amendment of any of the terms and conditions of the Note, to the extent required by applicable law, notice of a new meeting resulting from adjournment of the initial meeting for lack of quorum will be given not less than eight days prior to the date fixed for such new meeting and will be published for three business days in Argentina in the Official Gazette of Argentina (Boletín Oficial), a newspaper of general circulation in Argentina and in the Bulletin of the MAE (as long as the Notes are listed on the MAE). To be entitled to vote at a meeting of holders, a person shall be (i) a holder of one or more Notes as of the relevant record date or (ii) a person appointed by an instrument in writing as proxy by such a holder of one or more Notes.

The quorum at any ordinary meeting called to adopt a resolution will be persons holding or representing a majority in aggregate principal amount of the outstanding Notes and at any reconvened adjourned ordinary meetings will be any person(s) present at such reconvened adjourned meeting. The quorum at any extraordinary meeting called to adopt a resolution will be persons holding or representing at least 60% in aggregate principal amount of the outstanding Notes and at any reconvened adjourned extraordinary meeting will be persons holding or representing at least 30% in aggregate principal amount of the outstanding Notes. At a meeting or a reconvened adjourned meeting duly convened and at which a quorum is present, any resolution to modify or amend, or to waive compliance with, any provision of the Notes (other than the provisions referred to in the fourth preceding paragraph) will be validly passed and decided if approved by the persons entitled to vote a majority in aggregate principal amount of the Notes then outstanding represented and voting at the meeting. Any instrument given by or on behalf of any holder of a Note in connection with any consent to any such modification, amendment or waiver will be irrevocable once given and will be conclusive and binding on all subsequent holders of such Note. Any modifications, amendments or waivers to the Indenture or to the Notes will be conclusive and binding upon all holders of Notes whether or not they have given such consent or were present at any meeting.

The Issuer will designate the record date for determining the holders of Notes entitled to vote at any meeting and the Issuer will provide notice to holders of Notes in the manner set forth herein. The holder of a Note may, at any meeting of holders of Notes at which such holder is entitled to vote, cast one vote for each U.S. dollar in principal amount of the Notes held by such holder in which such Notes are denominated.

For purposes of the above, any Note authenticated and delivered pursuant to the Indenture will, as of any date of determination, be deemed to be “outstanding,” except:

- (i) Notes theretofore canceled by the Trustee;
- (ii) Notes that have been called for redemption or tendered for repurchase in accordance with the terms hereof or which have become due and payable at maturity or otherwise and with respect to which monies sufficient to pay the principal thereof and any premium, interest, Additional Amounts or other amount thereon have been deposited with the Issuer or with the Trustee; or
- (iii) Notes in lieu of or in substitution for which other Notes have been authenticated and delivered; *provided* that in determining whether the holders of the requisite principal amount of outstanding Notes are present at a meeting of holders of Notes for quorum purposes or have consented to or voted in favor of any notice, consent, waiver, amendment, modification or supplement under the Indenture, Notes owned directly or indirectly by the Issuer or any of its Affiliates, including any Subsidiary, will be disregarded and deemed not to be outstanding.

Promptly after the execution by the Issuer and the Trustee of any supplement or amendment to the Indenture, the Issuer will give notice thereof to the holders of the Notes and, if applicable, to the CNV, setting forth in general terms the substance of such supplement or amendment. If the Issuer fails to give such notice to the holders of the Notes within 15 days after the execution of such supplement or amendment, the Trustee will give notice to the holders at the Issuer’s expense. Any failure by the Issuer or the Trustee to give such notice, or any defect therein, will not, however, in any way impair or affect the validity of any such supplement or amendment.

To the extent that the Notes are listed on the Luxembourg Stock Exchange for trading on the Euro MTF Market or listed on any other securities exchange, such meetings of holders and notices thereof will also comply with the applicable rules of the Luxembourg Stock Exchange or such securities exchange, as applicable.

### **Enforcement by Holders of Notes**

Except as described in the next paragraph, no holder of a Note will have any right by virtue of or by availing itself of any provision of the Indenture or such Note to institute any suit, action or proceeding in equity or at law upon or under the Notes or for the appointment of a receiver or trustee, or for any other remedy thereunder, unless (i) such holder previously has given to the Trustee written notice of a default with respect to the Notes, (ii) holders of not less than 25% in aggregate principal amount of the outstanding Notes have made written request upon the Trustee to institute such action, suit or proceeding in its own name as trustee under the Indenture and have offered to the Trustee such reasonable indemnity as it may require against the costs, expenses and liabilities to be Incurred therein or thereby and (iii) the Trustee for 60 days after its receipt of such notice, request and offer of indemnity has failed to institute any such action, suit or proceeding and no direction inconsistent with such written request has been given to the Trustee pursuant to the Indenture.

Notwithstanding any other provision in the Indenture and any provision of any Note issued under the Indenture, the right of any holder of Notes to receive payment of the principal, any premium, and interest on such Note (and Additional Amounts, if any) on or after the respective due dates expressed in such Note, or to institute suit, including a summary proceeding (*accion ejecutiva individual*) pursuant to Article 29 of the Argentine Negotiable Obligations Law, for the enforcement of any such payment on or after such respective dates, will not be impaired or affected without the consent of such holder.

Any beneficial owner of Notes issued under the Indenture represented by a global Note will be able to obtain from the relevant depository, upon request and subject to certain limitations set forth in the Indenture, a certificate representing its interest in the relevant global Note in accordance with the Argentine Capital Markets Law. This certificate will enable such beneficial owner to initiate legal action before any competent court in Argentina, including a summary proceeding, to obtain overdue amounts under the Notes.

### **Defeasance**

The Issuer may, at its option, elect to terminate (1) all of its obligations with respect to the Notes (“legal defeasance”), except for certain obligations, including those regarding any trust established for defeasance and obligations relating to the transfer and exchange of the Notes, the replacement of mutilated, destroyed, lost or stolen Notes and the maintenance of agencies with respect to the Notes and the rights, protections, immunities and indemnities of the Trustee and the Issuer’s obligations with respect thereto or (2) its obligations under certain of the covenants in the Indenture, so that any failure to comply with such obligations will not constitute an Event of Default (“covenant defeasance”). In order to exercise either legal defeasance or covenant defeasance, the Issuer must irrevocably deposit with the Trustee money or U.S. government obligations, or any combination thereof in such amounts as will be sufficient, in the written opinion of an internationally recognized firm of independent public accountants delivered to the Trustee, to pay the principal, premium, if any, and interest (and Additional Amounts, if any) in respect of the Notes then outstanding on the Stated Maturity of the Notes, and comply with certain other conditions, including, without limitation, the delivery to the Trustee of an opinion of a nationally recognized counsel in the United States experienced in such tax matters to the effect that the deposit and related defeasance would not cause the holders of the Notes to recognize income, gain or loss for U.S. federal income tax purposes. In the case of legal defeasance, such opinion of counsel must be based on a ruling from the U.S. Internal Revenue Service or a change in the applicable U.S. federal income tax law.

### **Repayment of Monies; Prescription**

Any monies deposited with or paid to the Trustee or any Paying Agent for the payment of the principal of or interest or any other amounts payable on or in respect of any Note (and Additional Amounts, if any) and not applied but remaining unclaimed for two years after the date upon which such principal or interest or other amounts have become due and payable will, unless otherwise required by mandatory provisions of applicable escheat or abandoned or unclaimed property law, be repaid to the Issuer by the Trustee or such Paying Agent, and the holder of such Note

will, unless otherwise required by mandatory provisions of applicable escheat or abandoned or unclaimed property laws, thereafter look only to the Issuer for any payment that such holder may be entitled to collect, and all liability of the Trustee or any Paying Agent with respect to such monies will thereupon cease.

All claims against the Issuer for the payment of principal of or interest or any other amounts payable on or in respect of any Note (and Additional Amounts, if any) will prescribe unless made within five years for principal and two years for interest from the date on which such payment first became due, or a shorter period if provided by applicable law.

## **Notices**

Notices to holders of non-global notes will be mailed to them, by first class mail, postage prepaid, at their registered addresses. Notices to holders of global notes will be given to DTC in accordance with its applicable procedures.

The Issuer will also be required to cause all such other publications of such notices as may be required from time to time in any manner by the provisions of the Argentine Capital Markets Law, the CNV Rules and by any applicable Argentine law and/or regulation (including without limitation publishing notices at the official site of the CNV ([www.cnv.gob.ar](http://www.cnv.gob.ar))).

For so long as any Notes are admitted for trading in the MAE, the Issuer will publish all notices in the on-line bulletin of the MAE.

For so long as any Notes are listed on the Luxembourg Stock Exchange and admitted for trading on the Euro MTF Market and the rules of such exchange so require, the Issuer will publish all notices to holders in English via the website of the Luxembourg Stock Exchange at <http://www.bourse.lu>, *provided* that such method of publication satisfies the rules of such exchange.

In addition, the Issuer will be required to cause all such other publications of such notices as may be required from time to time by applicable Argentine law. Neither the failure to give notice nor any defect in any notice given to any particular holder of a Note will affect the sufficiency of any notice with respect to any other Notes.

## **Currency Indemnity**

This is an international debt issuance transaction in which the specification of U.S. dollars and payment in New York City is of the essence, and the Issuer's obligations under the Notes and the Indenture to the Trustee and the holders of the Notes to make payment in U.S. dollars shall not be discharged or satisfied by any tender or recovery pursuant to any judgment expressed in or converted into any other currency or in another place except to the extent that on the Business Day following receipt of any sum adjudged to be so due in the judgment currency the payee may in accordance with normal banking procedures purchase U.S. dollars in the amount originally due with the judgment currency. If, for the purpose of obtaining judgment in any court, it is necessary to convert a sum due under the Notes and the Indenture in U.S. dollars into another currency (in this paragraph called the "judgment currency"), the rate of exchange shall be that at which, in accordance with normal banking procedures, such payee could purchase such U.S. dollars in New York, New York with the judgment currency on the Business Day immediately preceding the day on which such judgment is rendered. The Issuer's obligation in respect of any such sum due under the Notes and the Indenture shall, notwithstanding the rate of exchange actually applied in rendering such judgment, be discharged only to the extent that on the Business Day following receipt by the relevant payee of any sum adjudged to be due under the Notes and the Indenture in the judgment currency the relevant payee may, in accordance with normal banking procedures, purchase and transfer dollars to New York City with the amount of the judgment currency so adjudged to be due (giving effect to any set-off or counterclaim taken into account in rendering such judgment). Accordingly, the Issuer hereby, as a separate obligation and notwithstanding any such judgment, agrees to indemnify each of the holders of the Notes and the Trustee against, and to pay on demand, in U.S. dollars, the amount (if any, the "Excess") by which the sum originally due to the holders of the Notes or the Trustee in U.S. dollars under the Notes and the Indenture exceeds the amount of the U.S. dollars so purchased and transferred.

In the event that, on any payment date, any restrictions or prohibition of access to the Argentine foreign exchange market exists, the Issuer will seek to pay all amounts payable under the Notes in U.S. dollars either (i) by purchasing at market price securities of any series of U.S. dollar denominated Argentine sovereign bonds or any other securities or private or public bonds issued in Argentina, and transferring and selling such instruments outside Argentina for the U.S. dollars, to the extent permitted by applicable law, or (ii) by means of any other reasonable means permitted by law in Argentina, in each case, on such payment date. All costs and taxes payable in connection with the procedures referred to in (i) and (ii) above shall be borne by the Issuer.

Nothing in the Notes and the Indenture shall impair any of the rights of the holders of the Notes or the Trustee or justify the Issuer in refusing to make payments under the Notes and the Indenture in U.S. dollars for any reason whatsoever, including, without limitation, any of the following: (i) the purchase of U.S. dollars in Argentina by any means becoming more onerous or burdensome for the Issuer than as of the date hereof and (ii) the exchange rate in force in Argentina increasing significantly from that in effect as of the date hereof. The Issuer waives the right to invoke any defense of payment impossibility (including any defense under Section 1091 of the Argentine Civil and Commercial Code), impossibility of paying in U.S. dollars (assuming liability for any force majeure or act of God), or similar defenses or principles (including, without limitation, equity or sharing of efforts principles).

### **Governing Law, Judgments, Jurisdiction, Service of Process, Waiver of Immunities**

The Indenture and the Notes shall be governed by, and construed in accordance with, the laws of the State of New York; *provided* that all matters relating to the due authorization, execution, issuance and delivery of the Notes by the Issuer, all matters relating to the legal requirements necessary in order for the Notes to qualify as “*obligaciones negociables*” under Argentine law, and certain matters related to meetings of holders of the Notes, including quorums, majorities, and requirements for convocation, shall be governed by the Argentine Negotiable Obligations Law, the Argentine General Companies Law No. 19,550 and/or other applicable Argentine laws and regulations.

The Issuer will submit to the non-exclusive jurisdiction of any state or federal court sitting in the Borough of Manhattan, City and State of New York, of any Argentine court sitting in the City of Buenos Aires, including the ordinary courts for commercial matters and the *Tribunal de Arbitraje del MAE* or the permanent arbitration tribunal from the market in Argentina in which the Notes are listed, under the provisions of Article 46 of Argentine Law No. 26,831, and any competent court in the place of its corporate domicile for purposes of any suit, action or proceeding arising out of or related to the Indenture or the Notes. The Issuer will irrevocably waive, to the fullest extent permitted by law, any objection which the Issuer may have to the laying of the venue of any such action or proceeding brought in such a court and any claim that any such action or proceeding brought in such a court has been brought in an inconvenient forum. The Issuer has also agreed that final judgment in any such action or proceeding brought in such court will be conclusive and binding upon it and may be enforced in any court in the jurisdiction to which the Issuer is subject by a suit upon such judgment; *provided* that service of process is effected upon the Issuer in the manner specified in the following paragraph.

As long as any Note remains outstanding, the Issuer will at all times have an authorized agent in the Borough of Manhattan in the City and State of New York upon whom process may be served in any legal action or proceeding arising out of or relating to the Notes or the Indenture. Service of process upon such agent and written notice of such service mailed or delivered to the party being joined in such action or proceeding will, to the extent permitted by law, be deemed in every respect effective service of process upon such party in any such legal action or proceeding. The Issuer has appointed Cogency Global Inc. as its agent for service of process in any proceedings in the Borough of Manhattan, City and State of New York.

The Issuer acknowledges and agrees that the activities contemplated by the provisions of the Indenture are commercial in nature rather than governmental or public and, therefore, acknowledges and agrees that it is not entitled to any right of immunity on the grounds of sovereignty or otherwise with respect to any such activities or in any legal action or proceeding arising out of or in any way relating to this Indenture. The Issuer, in respect of itself and its properties and revenues, expressly and irrevocably waives any such right of immunity (including any immunity from the jurisdiction of any court or from service of process or from any execution of judgment or from attachment prior to judgment or in aid of execution or otherwise) or claim thereto which may now or hereafter exist, and agrees not to assert any such right or claim in any such action or proceeding, whether in the United States or otherwise.

## **Trustee**

The Notes will be issued in accordance with the Indenture. The Indenture contains provisions relating to the duties and responsibilities of the Trustee and its obligations to the holders of the Notes.

The Trustee may resign at any time and the holders of a majority in aggregate principal amount of the outstanding Notes may remove the Trustee at any time. If the Trustee has or shall acquire a conflicting interest within the meaning of the Trust Indenture Act, the Trustee shall either eliminate such interest or resign in accordance with the Trust Indenture Act. The Issuer may remove the Trustee if the Trustee becomes ineligible to serve as Trustee under the terms of the Indenture, becomes incapable of acting as Trustee, or is adjudged insolvent or bankrupt. If the Trustee resigns or is removed, a successor Trustee will be appointed in accordance with the terms of the Indenture. The Issuer will give notice of any resignation, termination or appointment of the Trustee to the holders of the Notes and to the CNV.

In the Indenture, the Issuer will covenant to indemnify and defend the Trustee for, and to hold it harmless against, any loss, damage, cost, claim, liability or documented expense (including the reasonable costs and documented expenses of its counsel) arising out of or in connection with the acceptance or administration of the Indenture or the trusts thereunder and the performance of its duties and the exercise of its rights thereunder, including in each of its capacities hereunder as Co-Registrar, Principal Paying Agent and Transfer Agent, except to the extent such loss, liability or expense is due to its own negligence or willful misconduct.

The Indenture will provide that the Trustee or any Affiliate or agent of the Trustee may become the owner or pledgee of securities with the same rights it would have if it were not the Trustee or any agent of the Trustee and may otherwise deal with the Issuer and receive, collect, hold and retain collections from the Issuer with the same rights it would have if it were not the Trustee. The Trustee and its Affiliates and agents are entitled to enter into business transactions with the Issuer or any of its Affiliates without accounting for any profit resulting from such transactions.

## **Paying Agents; Transfer Agents; Registrars**

The Issuer has initially appointed The Bank of New York Mellon, as Paying Agent, Transfer Agent and Registrar. The Issuer may at any time appoint additional or other Registrars, Paying Agents and Transfer Agents and terminate the appointment thereof; *provided, however*, that (i) while Notes issued under the Indenture are outstanding, the Issuer will maintain a Registrar, a Paying Agent and a Transfer Agent in New York City; (ii) as long as the Notes are listed on the Official List of the Luxembourg Stock Exchange for trading on the Luxembourg Stock Exchange and the rules of the Euro MTF market so require, at least one Paying Agent and Transfer Agent will be located in Luxembourg; and (iii) as long as it is required by Argentine law or by the CNV, the Issuer will maintain a Registrar, a Paying Agent and a Transfer Agent in the City of Buenos Aires. In the event required by the Indenture, notice of any resignation, termination or appointment of any Registrar, Paying Agent or Transfer Agent, and of any change in the office through which any Registrar, Paying Agent or Transfer Agent will act, will be promptly given to the holders of the Notes in the manner described under “—Notices” above.

The Trustee, the Paying Agents, the Transfer Agents, Registrar and Co-Registrar will make no representation regarding this offering memorandum or the matters contained herein.

## **No Personal Liability of Directors, Officers, Employees, Incorporators, Members or Stockholders**

Except as specifically provided under Argentine law, no director, officer, employee, incorporator, member or stockholder of the Issuer, as such, will have any liability for any obligations of the Issuer under the Notes or the Indenture or for any claim based on, in respect of, or by reason of, such obligations. To the extent permitted by applicable law, each holder of Notes by accepting a Note waives and releases all such liability.

## **Certain Definitions**

“*Acquired Indebtedness*” means Indebtedness of a Person existing at the time the Person merges with or into or becomes a Restricted Subsidiary and not Incurred in connection with, or in contemplation of, the Person merging with or into or becoming a Restricted Subsidiary. Acquired Indebtedness will be deemed to have been Incurred at the

time such Person becomes a Restricted Subsidiary or at the time it merges or consolidates with the Issuer or a Restricted Subsidiary or at the time such Indebtedness is assumed in connection with the acquisition of assets from such Person.

“*Additional Assets*” means:

- (1) any property or assets (other than Indebtedness and Capital Stock) to be used by the Issuer or a Restricted Subsidiary engaged in a Related Business; and
- (2) the Capital Stock of a Person engaged in a Related Business that becomes a Restricted Subsidiary as a result of the acquisition of such Capital Stock by the Issuer or another Restricted Subsidiary.

“*Adjusted EBITDA*” means, for any period, Consolidated Net Income, increased (without duplication) by the followings items to the extent deducted in calculating Consolidated Net Income:

- (1) financial expense, net, plus
- (2) consolidated income taxes, other than income taxes or income tax adjustments (whether positive or negative) attributable to Asset Sales or extraordinary gains or losses; plus
- (3) consolidated depreciation and amortization expense;

in each case to be determined in accordance with IFRS and as set forth in the most recent consolidated financial statements of the Issuer delivered to the Trustee pursuant to the Indenture.

For purposes of the calculation of Adjusted EBITDA in U.S. dollars, amounts in Argentine pesos for each quarter of the relevant Reference Period will be converted to U.S. dollars at the average of the daily seller’s exchange rate for wire transfers (*divisas*) published by the Banco de la Nación Argentina for such quarter, and then, the amount in U.S. dollars for each of the four quarters of the Reference Period will be added up resulting in the U.S. dollar amount for such Reference Period.

“*Adjusted Treasury Rate*” means, with respect to any redemption date, the rate per annum equal to the semi-annual equivalent yield to the 2023 Call Date or interpolated maturity (on a day count basis) of the Comparable Treasury Issue, assuming a price for the Comparable Treasury Issue (expressed as a percentage of its principal amount) equal to the Comparable Treasury Price for such redemption date.

“*Affiliate*” of any specified Person means any other Person directly or indirectly controlling or controlled by or under direct or indirect common control with such specified Person. For the purposes of this definition, “control” when used with respect to any specified Person means the power to direct or cause the direction of the management and policies of such Person, directly or indirectly, whether through the ownership of voting securities, by contract or otherwise; and the terms “controlling” and “controlled” have meanings correlative to the foregoing.

“*Asset Sale*” means any sale, lease, transfer or other disposition of any assets by the Issuer or any Restricted Subsidiary, including by means of a merger, consolidation or similar transaction and including any sale or issuance of the Equity Interests of any Restricted Subsidiary (each of the above referred to as a “disposition”), *provided* that the following are not included in the definition of “Asset Sale”:

- (1) a disposition to the Issuer or a Restricted Subsidiary, including the sale or issuance by the Issuer or any Restricted Subsidiary of any Equity Interests of any Restricted Subsidiary to the Issuer or any Restricted Subsidiary;
- (2) the disposition by the Issuer or any Restricted Subsidiary of cash or Cash Equivalents;
- (3) the disposition by the Issuer or any Restricted Subsidiary in the ordinary course of business of (i) inventory and other assets held for sale in the ordinary course of business, (ii) damaged, worn out



- or obsolete assets that are no longer useful in the conduct of the business of the Issuer and its Restricted Subsidiaries, (iii) rights granted to others pursuant to leases or licenses or (iv) any property, rights or assets upon expiration in accordance with the terms of any concession;
- (4) the sale or discount of accounts receivable arising in the ordinary course of business in connection with the compromise, settlement or collection thereof;
  - (5) a transaction covered by “—Certain Covenants—Mergers, Consolidations, Sales, Leases”;
  - (6) a Restricted Payment permitted under “—Certain Covenants—Limitation on Restricted Payments”;
  - (7) the issuance of Disqualified Stock or Preferred Stock pursuant to “—Certain Covenants—Limitation on Indebtedness;”
  - (8) the surrender or waiver of contract rights or the settlement, release or surrender of contract, tort or other claims;
  - (9) the creation of a Permitted Lien; and
  - (10) any disposition in a transaction or series of related transactions of assets with a fair market value of less than the greater of (x) US\$5.0 million (or the equivalent in other currencies) or (y) 2.0% of Consolidated Net Tangible Assets.

“*Average Life*” means, with respect to any Indebtedness, the quotient obtained by dividing (i) the sum of the products of (x) the number of years from the date of determination to the dates of each successive scheduled principal payment of such Indebtedness and (y) the amount of such principal payment by (ii) the sum of all such principal payments.

“*Board of Directors*” means the Board of Directors of the Issuer or any committee of the Board of Directors of the Issuer, or officers of the Issuer, duly authorized to act for it in respect hereof.

“*Business Day*” means a day other than a Saturday, Sunday or any day on which banking institutions are authorized or required by law to close in New York City, New York or the City of Buenos Aires, Argentina.

“*Capital Stock*” means, with respect to any Person, any and all shares, interests, participations, warrants, options, rights or other equivalents of or interests in (however designated and whether voting or non-voting) corporate stock of a corporation and any and all equivalent ownership interests in a Person (other than a corporation), in each case whether now outstanding or hereafter issued, including any preferred stock.

“*Cash Equivalents*” means:

- (1) U.S. dollars, Argentine pesos or money in other currencies received in the ordinary course of business;
- (2) U.S. Government Obligations or certificates representing an ownership interest in U.S. Government Obligations or (ii) marketable general obligations issued or unconditionally guaranteed by Argentina or the Argentine Central Bank, in each case with maturities not exceeding one year from the date of acquisition;
- (3) (i) demand deposits, (ii) time deposits and certificates of deposit with maturities of one year or less from the date of acquisition, (iii) bankers’ acceptances with maturities not exceeding one year from the date of acquisition, and (iv) overnight bank deposits, in each case with any bank or trust company organized or licensed under the laws of (x) Argentina or any political subdivision thereof having one of the four highest international or local ratings obtainable by S&P, Moody’s or Fitch or such similar equivalent rating by at least one “nationally recognized statistical rating organization”

registered under Section 15E of the Exchange Act or (y) the United States or any state thereof having capital, surplus and undivided profits in excess of US\$500.0 million whose short-term debt is rated “A-2” or higher by S&P, or “P-2” or higher by Moody’s (or such equivalent rating by at least one nationally recognized statistical rating organization registered under Section 15E of the Exchange Act);

- (4) repurchase obligations with a term of not more than seven days for underlying securities of the type described in clauses (2) and (3) above entered into with any financial institution meeting the qualifications specified in clause (3) above;
- (5) (i) commercial paper rated at least “P-1” by Moody’s or “A-1” by S&P and (ii) commercial paper of an Argentine issuer the long-term unsecured debt obligations of which are rated the highest international rating of an Argentine issuer, in each case, maturing within one year after the date of acquisition;
- (6) *fondos comunes de inversión* (Argentine funds focused primarily on in-country cash management investments) that have a local rating of at least “A-bf.ar” by Moody’s or the equivalent by Fitch or S&P (or their respective Affiliates in Argentina, including without limitation, Fix Scr S.A.); or
- (7) money market funds at least 90% of the assets of which consist of investments of the type described in clauses (1) through (6) above.

“*Capital Lease*” means, with respect to any Person, any lease of any property which, in conformity with IFRS, is required to be capitalized on the balance sheet of such Person.

“*Change of Control*” means the occurrence of an event or series of events that results in: (1) prior to the consummation of an IPO, YPF ceasing to be the beneficial owner, directly or indirectly, of at least 50% of the voting power of the Capital Stock of the Issuer; and (2) after the consummation of an IPO, if a Person becomes the beneficial owner, directly or indirectly, of 35% or more of the voting power of the Capital Stock of the Issuer if such holding is more than the voting power of the Capital Stock of the Issuer beneficially owned, directly or indirectly, by YPF or its Affiliates.

“*Change of Control Offer*” has the meaning set forth in “—Redemption and Repurchase—Repurchase Offer upon a Change of Control Repurchase Event.”

“*Change of Control Payment*” has the meaning set forth in “—Redemption and Repurchase—Repurchase Offer upon a Change of Control Repurchase Event.”

“*Change of Control Payment Date*” has the meaning set forth in “—Redemption and Repurchase—Repurchase Offer upon a Change of Control Repurchase Event.”

“*Change of Control Repurchase Event*” means the occurrence of both a Change of Control and a Rating Downgrade Event.

“*Common Stock*” means with respect to any Person, any and all shares, interests or other participations in, and other equivalents (however designated and whether voting or nonvoting) of such Person’s common stock, whether or not outstanding on the Issue Date, and includes, without limitation, all series and classes of such common stock.

“*Comparable Treasury Issue*” means the U.S. Treasury security or securities selected by an independent investment banking institution of international standing appointed by the Issuer having an actual or interpolated maturity comparable to the term ended on the 2023 Call Date that would be utilized, at the time of selection and in accordance with customary financial practice, in pricing new issues of corporate debt securities with a maturity comparable to term ended on the 2023 Call Date.

“*Comparable Treasury Price*” means, with respect to any redemption date:

- (1) the average of the bid and asked prices for the Comparable Treasury Issue (expressed in each case as a percentage of its principal amount) on the third Business Day preceding such redemption date, as set forth in the daily statistical release (or any successor release) published by the Federal Reserve Bank of New York and designated “Composite 3:30 P.M. Quotations for U.S. Government Securities;” or
- (2) if such release (or any successor release) is not published or does not contain such prices on such Business Day, (a) the average of the Reference Treasury Dealer Quotations for such redemption date, after excluding the highest and lowest of such Reference Treasury Dealer Quotations, or (b) if fewer than three such Reference Treasury Dealer Quotations are available, the average of all such quotations.

“*Consolidated Interest Expense*” means, for any period, the consolidated interest expense in accordance with IFRS of the Issuer and its Restricted Subsidiaries in respect of Indebtedness, plus, to the extent not included in such consolidated interest expense, and to the extent Incurred, accrued or payable by the Issuer or its Restricted Subsidiaries in respect of Indebtedness, without duplication:

- (1) interest expense attributable to Capital Lease or Sale and Leaseback Transactions;
- (2) amortization of debt discount and debt issuance costs;
- (3) capitalized interest;
- (4) non-cash interest expense;
- (5) commissions, discounts and other fees and charges owed with respect to letters of credit and bankers’ acceptance financing;
- (6) net cash costs associated with Hedging Agreements related to Indebtedness; and
- (7) any of the above expenses with respect to Indebtedness of another Person Guaranteed by the Issuer or any of its Restricted Subsidiaries, as determined on a consolidated basis and in accordance with IFRS.

For purposes of the calculation of Consolidated Interest Expense in U.S. dollars, amounts in Argentine pesos for each quarter of the relevant Reference Period will be converted to U.S. dollars at the average of the daily seller’s exchange rate for wire transfers (*divisas*) published by the Banco de la Nación Argentina for such quarter, and then, the amount in U.S. dollars for each of the four quarters of the Reference Period will be added up resulting in the U.S. dollar amount for such Reference Period.

“*Consolidated Net Income*” means, for any period, the net income (or loss) of the Issuer and its Restricted Subsidiaries for such period determined on a consolidated basis in conformity with IFRS; *provided* that the following (without duplication) will be excluded in computing Consolidated Net Income:

- (1) the net income (but not loss) of any Restricted Subsidiary to the extent that a corresponding amount could not be distributed to the Issuer or another Restricted Subsidiary at the date of determination without any government approval (that has not been obtained) or by charter or by any agreement, instrument, judgment, decree, order, statute, rule or governmental regulation applicable to such distribution;
- (2) the net income (or loss) of any Person that is not the Issuer or a Restricted Subsidiary, except to the extent of the amount of dividends or other distributions actually paid in cash to the Issuer or any of its Restricted Subsidiaries by such Person during such period or to the extent that a loss was funded with cash or other contributions from the Issuer or a Restricted Subsidiary;

- (3) any net after-tax gains or losses attributable to Asset Sales;
- (4) any net after-tax extraordinary gains or losses; and
- (5) the cumulative effect of a change in accounting principles.

“*Consolidated Net Tangible Assets*” means, at any time, the total of all assets appearing on a consolidated balance sheet of the Issuer and its Restricted Subsidiaries, net of all applicable reserves and excluding goodwill, tradenames, trademarks, patents, unamortized debt discount and all other like intangible assets, less the aggregate of the current liabilities of the Issuer and its Restricted Subsidiaries appearing on such balance sheet as of such date on a consolidated basis determined in accordance with IFRS.

“*Deeply Subordinated Indebtedness*” means any Subordinated Indebtedness of the Issuer which is (i) subordinated in right of payment to the Notes, pursuant to a written agreement to that effect, (ii) (A) does not mature or require any amortization, redemption or other repayment of principal (other than through conversion or exchange of such Indebtedness into Qualified Stock of the Issuer or any Indebtedness meeting the requirements of this definition), (B) does not require payment of any cash interest or any similar cash amounts, (C) contains no change of control or similar provisions and (D) does not accelerate and has no right to declare a default or event of default or take any enforcement action or otherwise require any cash payment of the Issuer (other than as a result of insolvency proceedings of the Issuer), in each case, prior to the 90th day following the Stated Maturity of the Notes and all other amounts due under the Indenture, (iii) does not provide for or require any security interest or encumbrance over any asset of the Issuer or any Restricted Subsidiary and (iv) does not (including upon the happening of any event) restrict the payment of amounts due in respect of the Notes or compliance by the Issuer with its obligations under the Notes and the Indenture.

“*Default*” means any event that is, or after notice or passage of time or both would be, an Event of Default.

“*Disqualified Equity Interests*” means Equity Interests that by their terms or upon the happening of any event are:

- (1) required to be redeemed or redeemable at the option of the holder prior to the Stated Maturity of the Notes for consideration other than Qualified Equity Interests, or
- (2) convertible at the option of the holder into Disqualified Equity Interests or exchangeable for Indebtedness.

“*Disqualified Stock*” means Capital Stock constituting Disqualified Equity Interests.

“*Equity Interests*” means all Capital Stock and all warrants or options with respect to, or other rights to purchase, Capital Stock, but excluding Indebtedness convertible into equity.

“*Equity Offering*” means an offering or placement for cash, after the Issue Date, of Qualified Stock of the Issuer or of any direct or indirect parent of the Issuer (to the extent the proceeds thereof are contributed to the Capital Stock of the Issuer in the form of Qualified Stock).

“*Exchange Act*” means the U.S. Securities Exchange Act of 1934, as amended, or any successor statute or statutes thereto.

“*Government Agency*” means any public legal entity or public agency, created by federal, state or local government, or any other legal entity now existing or hereafter created, or now or hereafter owned or controlled, directly or indirectly, by any public legal entity or public agency.

“*Guarantee*” means any obligation, contingent or otherwise, of any Person directly or indirectly guaranteeing any Indebtedness of any other Person:

(a) to purchase or pay, (or advance or supply funds for the purchase or payment of), such Indebtedness of such other Person, (whether arising by virtue of partnership arrangements, or by agreement to keep-well, to purchase assets, goods, securities or services, to take-or-pay, or to maintain financial statement conditions or otherwise), or

(b) entered into for purposes of assuring in any other manner the obligee of such Indebtedness of the payment thereof or to protect such obligee against loss in respect thereof, in whole or in part,

*provided*, that the term “Guarantee” shall not include endorsements for collection or deposit in the ordinary course of business. The term “Guarantee” used as a verb has a corresponding meaning.

“*Hedging Agreement*” means (i) any interest rate swap agreement, interest rate cap agreement or other agreement, (ii) any foreign exchange forward contract, currency swap agreement or other agreement or (iii) commodity futures agreements or other similar agreement.

“*IFRS*” means the International Financial Reporting Standards issued by the International Accounting Standards Board as in effect from time to time. For the avoidance of doubt, all financial information of the Issuer calculated under the Indenture shall be prepared on the basis of its consolidated financial statements in accordance with IFRS.

“*Incur*” means, with respect to any Indebtedness or Capital Stock, to incur, create, issue, assume or Guarantee such Indebtedness or Capital Stock. If any Person becomes a Restricted Subsidiary on any date after the date of the Indenture (including by redesignation of an Unrestricted Subsidiary or failure of an Unrestricted Subsidiary to meet the qualifications necessary to remain an Unrestricted Subsidiary), the Indebtedness and Capital Stock of such Person outstanding on such date will be deemed to have been Incurred by such Person on such date for purposes of “— Certain Covenants— Limitation on Indebtedness.” The accretion of original issue discount or payment of interest in kind will not be considered an Incurrence of Indebtedness.

“*Indebtedness*” means, with respect to any Person, without duplication:

- (1) all indebtedness of such Person for borrowed money;
- (2) all obligations of such Person evidenced by bonds, debentures, notes or other similar instruments;
- (3) all obligations of such Person in respect of letters of credit, bankers’ acceptances or other similar instruments, excluding obligations in respect of trade letters of credit or bankers’ acceptances or other similar instruments issued in respect of trade payables to the extent not drawn upon or presented, or, if drawn upon or presented, the resulting obligation of the Person is paid within 30 days;
- (4) all obligations of such Person to pay the deferred and unpaid purchase price of property or services which are recorded as liabilities under IFRS, excluding trade payables arising in the ordinary course of business;
- (5) all obligations of such Person as lessee under Capital Leases;
- (6) all Indebtedness of other Persons Guaranteed by such Person to the extent so Guaranteed;
- (7) all Indebtedness of other Persons secured by a Lien on any asset of such Person, whether or not such Indebtedness is assumed by such Person;
- (8) all obligations of such Person under Hedging Agreements; and
- (9) all Disqualified Stock (the amount of Indebtedness therefrom deemed to equal any involuntary liquidation preference plus accrued and unpaid dividends).

The amount of Indebtedness of any Person will be deemed to be:

- (A) with respect to contingent obligations, the maximum liability upon the occurrence of the contingency giving rise to the obligation; *provided* that, with respect to Indebtedness consisting of performance, bid, surety, appeal or similar bonds (including, for the avoidance of doubt, *seguros de caución*) or completion guarantees, only when, and to the extent, such amounts constitute reimbursement obligations of such Person;
- (B) with respect to Indebtedness secured by a Lien on an asset of such Person but not otherwise the obligation, contingent or otherwise, of such Person, the lesser of (x) the fair market value of such asset on the date the Lien attached and (y) the amount of such Indebtedness;
- (C) with respect to any Indebtedness issued with original issue discount, the face amount of such Indebtedness less the remaining unamortized portion of the original issue discount of such Indebtedness;
- (D) with respect to any Hedging Agreement, the net amount payable if such Hedging Agreement terminated at that time due to default by such Person; and
- (E) otherwise, the outstanding principal amount thereof.

“*Interest Coverage Ratio*” means, on any date (the “transaction date”), the ratio for the Issuer of:

- (i) the aggregate amount of Adjusted EBITDA for the four fiscal quarters immediately prior to the determination date for which internal financial statements are available (the “Reference Period”) to
- (ii) the aggregate Consolidated Interest Expense during such Reference Period. In making the foregoing calculation,
  - (A) pro forma effect will be given to any Indebtedness, Disqualified Stock or Preferred Stock Incurred during or after the Reference Period to the extent the Indebtedness, Disqualified Stock or Preferred Stock is outstanding or is to be Incurred on the transaction date as if the Indebtedness, Disqualified Stock or Preferred Stock had been Incurred on the first day of the Reference Period;
  - (B) pro forma calculations of interest on Indebtedness bearing a floating interest rate will be made as if the rate in effect on the transaction date (taking into account any Hedging Agreement applicable to the Indebtedness if the Hedging Agreement has a remaining term of at least 12 months) had been the applicable rate for the entire Reference Period;
  - (C) Consolidated Interest Expense related to any Indebtedness, Disqualified Stock or Preferred Stock no longer outstanding or to be repaid, repurchased or redeemed on the transaction date, except for Consolidated Interest Expense accrued during the Reference Period under a revolving credit to the extent of the commitment thereunder (or under any successor revolving credit) in effect on the transaction date, will be excluded; and
  - (D) pro forma effect will be given to:
    - (i) the creation, designation or redesignation of Restricted and Unrestricted Subsidiaries,
    - (ii) the acquisition or disposition of companies, divisions or lines of businesses by the Issuer and its Restricted Subsidiaries, including any acquisition or disposition of a company, division or line of business since the beginning of the Reference Period

by a Person that became a Restricted Subsidiary after the beginning of the Reference Period, and

- (iii) the discontinuation of any discontinued operations,

in each case, that have occurred since the beginning of the Reference Period as if such events had occurred on the first day of the Reference Period. To the extent that pro forma effect is to be given to an acquisition or disposition of a company, division or line of business, the pro forma calculation will be based upon the most recent four full fiscal quarters for which the relevant financial information is available.

*“Investment”* means:

- (1) any direct or indirect advance, loan or other extension of credit to another Person;
- (2) any capital contribution to another Person, by means of any transfer of cash or other property or in any other form;
- (3) any purchase or acquisition of Equity Interests, bonds, notes or other Indebtedness, or other similar instruments or securities issued by another Person, including the receipt of any of the above as consideration for the disposition of assets or rendering of services; or
- (4) any Guarantee of any obligation of another Person.

If the Issuer or any Restricted Subsidiary (x) sells or otherwise disposes of any Equity Interests of any direct or indirect Restricted Subsidiary so that, after giving effect to that sale or disposition, such Person is no longer a Subsidiary of the Issuer, or (y) designates any Restricted Subsidiary as an Unrestricted Subsidiary in accordance with the provisions of the Indenture, all remaining Investments of the Issuer and its Restricted Subsidiaries in such Person shall be deemed to have been made at such time.

*“Investment Grade”* means a rating equal to or higher than Baa3 (or the equivalent) by Moody’s and BBB- (or the equivalent) by S&P and Fitch, in each case, with a stable or better outlook.

*“IPO”* means a public offering in the United States registered with the SEC and/or in Argentina registered with the CNV for cash by the Issuer or any direct or indirect parent of the Issuer, as applicable, of its Common Stock or any other share of its Capital Stock (in the case of an offering by any direct or indirect parent of the Issuer, to the extent such cash proceeds are contributed to the Issuer), other than an issuance to any Subsidiary or any offering of Capital Stock issued in connection with a transaction that constitutes a Change of Control.

*“Issue Date”* means July 25, 2019.

*“Lien”* means any mortgage, pledge, encumbrance, security interest, charge or other encumbrance or preferential arrangement having the effect of constituting a security interest, including, without limitation, the equivalent created or arising under the laws of any country where the Issuer or any of its Subsidiaries own property.

*“Net Cash Proceeds”* means, with respect to any Asset Sale, the proceeds of such Asset Sale in the form of cash (including (i) payments in respect of deferred payment obligations to the extent corresponding to, principal, but not interest, when received in the form of cash, and (ii) proceeds from the conversion of other consideration received when converted to cash), net of:

- (1) brokerage commissions and other fees and expenses related to such Asset Sale, including fees and expenses of counsel, accountants and investment bankers;
- (2) provisions for taxes as a result of such Asset Sale without regard to the consolidated results of operations of the Issuer and its Restricted Subsidiaries;

- (3) payments required to be made to holders of minority interests in Restricted Subsidiaries as a result of such Asset Sale or to repay Indebtedness outstanding at the time of such Asset Sale that is secured by a Lien on the property or assets sold; and
- (4) appropriate amounts to be provided as a reserve against liabilities associated with such Asset Sale, including pension and other post-employment benefit liabilities, liabilities related to environmental matters and indemnification obligations associated with such Asset Sale, with any subsequent reduction of the reserve other than by payments made and charged against the reserved amount to be deemed a receipt of cash.

“*Net Leverage Ratio*” means, on any date (the “transaction date”), the ratio of:

- (i) the aggregate amount of consolidated Indebtedness, net of cash and Cash Equivalents of the Issuer and its Restricted Subsidiaries (“*Net Indebtedness*”) to
- (ii) the aggregate amount of Adjusted EBITDA for the Reference Period prior to the transaction date.

In making the foregoing calculation:

- (1) any Indebtedness, Disqualified Stock or Preferred Stock Incurred after the date of the consolidated balance sheet used to determine Indebtedness that remains outstanding on the transaction date, or any Indebtedness, Disqualified Stock or Preferred Stock that is to be Incurred on the transaction date, will be included as if Incurred at the beginning of such Reference Period and outstanding on the date of such consolidated balance sheet;
- (2) any Indebtedness, Disqualified Stock or Preferred Stock no longer outstanding, or to be repaid, repurchased or redeemed, retired, defeased or otherwise discharged on the transaction date will be excluded; and
- (3) pro forma effect will be given to:
  - (A) the creation, designation or redesignation of Restricted and Unrestricted Subsidiaries,
  - (B) the acquisition or disposition of companies, divisions or lines of businesses by the Issuer and its Restricted Subsidiaries, including any acquisition or disposition of a company, division or line of business since the beginning of such Reference Period by a Person that became a Restricted Subsidiary after the beginning of such Reference Period, and
  - (C) the discontinuation of any discontinued operations,

in each case, that have occurred since the beginning of such Reference Period as if such events had occurred on the first day of such Reference Period. To the extent that pro forma effect is to be given to an acquisition or disposition of a company, division or line of business, the pro forma calculation will be based upon the most recent four full fiscal quarters for which the relevant financial information is available.

For purposes of the calculation of Net Indebtedness in U.S. dollars, amounts in Argentine pesos as of the most recent relevant balance sheet date will be converted to U.S. dollars at the seller’s exchange rate for wire transfers (*divisas*) published by the Banco de la Nación Argentina as of the date of such balance sheet.

“*Non-Recourse Indebtedness*” means Indebtedness as to which neither the Issuer nor any Restricted Subsidiary provides any Guarantee and as to which the lenders have been notified in writing that they will not have any recourse to the stock or assets of the Issuer or any Restricted Subsidiary.



“*Officers’ Certificate*” means , with respect to any Person, a certificate signed by two officers of such Person, one of whom is the principal executive officer, the principal financial officer, the treasurer or the principal accounting officer, and either an assistant treasurer or an assistant secretary of such Person.

“*Permitted Investments*” means:

- (1) any Investment in the Issuer or in a Restricted Subsidiary, directly or indirectly engaged in a Related Business;
- (2) any Investment in Cash Equivalents;
- (3) any Investment by the Issuer or any Subsidiary of the Issuer in a Person, if as a result of such Investment,
  - (A) such Person becomes a Restricted Subsidiary engaged in a Related Business; or
  - (B) such Person is merged or consolidated with or into, or transfers or conveys substantially all its assets to, or is liquidated into, the Issuer or a Restricted Subsidiary engaged in a Related Business;
- (4) Investments received as non-cash consideration in an Asset Sale made pursuant to and in compliance with “—Certain Covenants—Limitation on Asset Sales” or a disposition of assets not constituting an Asset Sale;
- (5) Hedging Agreements otherwise permitted under the Indenture;
- (6) receivables owing to the Issuer or any Restricted Subsidiary created or acquired in the ordinary course of business and payable or dischargeable in accordance with customary trade terms; *provided* that such trade terms may include such concessionary trade terms as the Issuer or any such Restricted Subsidiary deems reasonable under the circumstances;
- (7) Guarantees issued in accordance with “—Certain Covenants—Limitation on Indebtedness”;
- (8) payroll, travel and other loans or advances to, or Guarantees issued to support the obligations of, officers and employees, in each case in the ordinary course of business, not in excess of US\$10.0 million (or the equivalent in other currencies) outstanding at any time;
- (9) Investments in any Project Finance Subsidiary (to the extent an Unrestricted Subsidiary) having an aggregate fair market value (taken together with all other Investments made pursuant to this clause (9) that are, at the time outstanding) not to exceed US\$100.0 million (or the equivalent in other currencies) at the time of such Investment (with the fair market value of each Investment being measured at the time made and without giving effect to subsequent changes in value); and
- (10) prepayments and other credits to suppliers made in the ordinary course of business.

“*Person*” means any individual, corporation (including a business trust), limited liability company, partnership, joint venture, association, joint stock company, trust, unincorporated organization or other entity, or government or any agency or political subdivision thereof.

“*Preferred Stock*” means, with respect to any Person, any and all Capital Stock which is preferred as to the payment of dividends or distributions, upon liquidation or otherwise, over another class of Capital Stock of such Person.

“*Project Finance Subsidiary*” means, with respect to any Project Financing, a Subsidiary that is the primary obligor in respect of such Project Financing.

“*Project Financing*” means Indebtedness or a Sale and Leaseback Transaction involving property of a Subsidiary the proceeds of which are applied to fund new acquisition, development or expansion by, or upgrades of the property of, such Subsidiary that is secured by the property or Capital Stock of such Subsidiary.

“*Qualified Equity Interests*” means all Equity Interests of a Person other than Disqualified Equity Interests.

“*Qualified Stock*” means all Capital Stock of a Person other than Disqualified Stock.

“*Rating Agency*” means each of Standard & Poor’s Ratings Group, Inc., or any successor thereto, Moody’s Investors Service, Inc., or any successor thereto, and Fitch, Inc., or any successor thereto.

“*Rating Downgrade Event*” means that at any time within 60 days (which period will be extended for so long as the rating of the Notes is under publicly announced consideration by any of the Rating Agencies then rating the Notes for possible downgrade due to a Change of Control, such extended period ending on such later day that the relevant Rating Agency announces its decision) after the earlier of (x) the date of public announcement of a Change of Control and (y) the date of delivery of written notice by the Issuer to the Rating Agencies then rating the Notes of its intention to effect a Change of Control, a downgrade of the Notes by (i) if three Rating Agencies are making ratings of the Notes publicly available, at least two of the Rating Agencies or (ii) if two or fewer Rating Agencies are making ratings of the Notes publicly available, then any one of the Rating Agencies, in each case, in whole or in part as a result of such Change of Control.

“*Redeemable Stock*” means any class or series of Capital Stock that by its terms or otherwise is required to be redeemed prior to the Stated Maturity of the Notes of the applicable series, or is redeemable at the option of the holder thereof at any time prior to the Stated Maturity of the Notes.

“*Refinance*” means, in respect of any Indebtedness, to issue any Indebtedness in exchange for or to refinance, repay, redeem, replace, defease or refund such Indebtedness in whole or in part. “*Refinanced*” and “*Refinancing*” will have correlative meanings.

“*Refinancing Indebtedness*” means Indebtedness of the Issuer or any Restricted Subsidiary issued to Refinance any other Indebtedness of the Issuer or a Restricted Subsidiary existing on the Issue Date or Incurred in compliance with the Indenture so long as:

- (1) the aggregate principal amount of such new Indebtedness as of the date of such proposed Refinancing does not exceed the aggregate principal amount of the Indebtedness to be Refinanced (plus accrued and unpaid interest premiums, fees and expenses related to such Refinancing); or
- (2) (x) such new Indebtedness does not have a Stated Maturity that is prior to (i) the Stated Maturity of the Indebtedness to be Refinanced, or (ii) the Stated Maturity of the Notes and (y) the Average Life of the new Indebtedness is equal to or greater than the remaining Average Life of the Indebtedness to be Refinanced;
- (3) if the Indebtedness being Refinanced is:
  - (A) Indebtedness of the Issuer, then such Refinancing Indebtedness will be Indebtedness of the Issuer;
  - (B) Subordinated Indebtedness, then the new Indebtedness, by its terms or by the terms of any agreement or instrument pursuant to which it is outstanding, will be expressly made subordinate in right of payment to the Notes at least to the extent that the Indebtedness to be Refinanced is subordinated to the Notes.

“*Related Business*” means any business conducted by the Issuer and its Restricted Subsidiaries on the Issue Date, and any business reasonably related, incidental, complementary or ancillary thereto (including, without limitation, any business in or related to the energy sector).

“*Restricted Subsidiary*” means any Subsidiary of the Issuer other than an Unrestricted Subsidiary.

“*Reversion Date*” has the meaning set forth under “—Suspension of Certain Covenants.”

“*S&P*” means Standard & Poor’s Ratings Services and its successors.

“*Sale and Leaseback Transaction*” means, with respect to any Person, an arrangement whereby such Person enters into a lease of property previously transferred by such Person to the lessor.

“*SEC*” means the U.S. Securities and Exchange Commission.

“*Significant Subsidiary*” means, at any relevant time, any of the Issuer’s Subsidiaries which is a “significant subsidiary” of ours within the meaning of Rule 1 -02 under Regulation S-X promulgated by the SEC, as in effect on the date of this Offering Memorandum.

“*Stated Maturity*” means (i) with respect to any Indebtedness, the date specified as the fixed date on which the final installment of principal of such Indebtedness is due and payable or (ii) with respect to any scheduled installment of principal of or interest on any Indebtedness, the date specified as the fixed date on which such installment is due and payable as set forth in the documentation governing such Indebtedness, not including any contingent obligation to repay, redeem or repurchase prior to the regularly scheduled date for payment.

“*Subordinated Indebtedness*” means any Indebtedness of the Issuer or any Restricted Subsidiary which is subordinated in right of payment to the Notes, pursuant to a written agreement to that effect.

“*Subsidiary*” means, with respect to any Person, any corporation, association or other business entity of which more than 50% of the voting power of the Capital Stock thereof is at the time owned or controlled, directly or indirectly, by such Person or one or more of the other Subsidiaries of such Person or a combination thereof.

“*Unrestricted Subsidiary*” means any Subsidiary of the Issuer that at the time of determination has previously been designated, and continues to be, an Unrestricted Subsidiary in accordance with “Certain Covenants—Designation of Restricted and Unrestricted Subsidiaries.” On the Issue Date, there are no Unrestricted Subsidiaries.

## FORM OF NOTES, CLEARING AND SETTLEMENT

### Global Notes

The Notes will be issued in fully registered global form, without interest coupons (the “Global Notes”), as follows:

- (i) Notes sold to qualified institutional buyers under Rule 144A will be represented by one or more permanent global certificates (the “Rule 144A Global Note”); and
- (ii) Notes sold in offshore transactions to non-U.S. persons in reliance on Regulation S will be represented by one or more permanent global certificates (the “Regulation S Global Note”).

Upon issuance, each of the Global Notes will be deposited with the trustee as custodian for DTC and registered in the name of Cede & Co., as nominee of DTC.

Ownership of beneficial interests in each Global Note will be limited to persons who have accounts with DTC (“DTC participants”) or persons who hold interests through DTC participants (including Euroclear and Clearstream). We expect that under procedures established by DTC:

- (i) upon deposit of each Global Note with DTC’s custodian, DTC will credit portions of the principal amount of the Global Note to the accounts of the DTC participants designated by the initial purchasers; and
- (ii) ownership of beneficial interests in each Global Note will be shown on, and transfer of ownership of those interests will be effected only through, records maintained by DTC (with respect to interests of DTC participants) and the records of DTC participants (with respect to other owners of beneficial interests in the Global Note).

Beneficial interests in the Global Notes may not be exchanged for Notes in physical, certificated form except in the limited circumstances described below.

Each Global Note and beneficial interests in each Global Note will be subject to restrictions on transfer as described under “Transfer Restrictions.”

### Transfers and Exchanges between the Global Notes

Beneficial interests in the Regulation S Global Note may be transferred to a person who takes delivery in the form of an interest in the Rule 144A Global Note only if such transfer is made pursuant to Rule 144A and the transferor first delivers to the trustee a certificate (in the form provided in the Indenture) to the effect that such transfer is being made to a person who the transferor reasonably believes is a qualified institutional buyer within the meaning of Rule 144A in a transaction meeting the requirements of Rule 144A and in accordance with all applicable securities laws of the states of the United States and other jurisdictions.

Beneficial interests in the Rule 144A Global Note may be transferred to a person who takes delivery in the form of a beneficial interest in the Regulation S Global Note only upon receipt by the trustee of a written certification (in the form provided in the Indenture) from the transferor to the effect that such transfer is being made in accordance with Regulation S.

The trustee shall be entitled to receive such evidence as may be reasonably requested by it to establish the identity and/or signatures of the transferor and transferee.

Transfers of beneficial interests within a Global Note may be made without delivery of any written certification or other documentation from the transferor or the transferee.

Transfers of beneficial interests in the Regulation S Global Note for beneficial interests in the Rule 144A Global Note or vice versa will be effected by DTC by means of an instruction originated through the DTC deposit/withdraw through the system of DTC's custodian. Accordingly, in connection with any transfer, appropriate adjustments will be made to reflect a decrease in the principal amount of the Regulation S Global Note and a corresponding increase in the principal amount of the Rule 144A Global Note or vice versa, as applicable. Any beneficial interest in one of the Global Notes that is transferred to a person who takes delivery in the form of an interest in another Global Note will, upon transfer, cease to be an interest in such Global Note and will become an interest in the other Global Note and, accordingly, will thereafter be subject to all transfer restrictions and other procedures applicable to beneficial interests in such other Global Note for so long as it remains such an interest.

### **Book-Entry Procedures for the Global Notes**

All interests in the Global Notes will be subject to the operations and procedures of DTC, Euroclear and Clearstream. We provide the following summaries of those operations and procedures solely for the convenience of investors. The operations and procedures of each settlement system are controlled by that settlement system and may be changed at any time. Neither we nor the initial purchasers are responsible for those operations or procedures.

DTC has advised that it is:

- (i) a limited purpose trust company organized under the New York State Banking Law;
- (ii) a "banking organization" within the meaning of the New York State Banking Law;
- (iii) a member of the U.S. Federal Reserve System;
- (iv) a "clearing corporation" within the meaning of the New York Uniform Commercial Code; and
- (v) a "clearing agency" registered under Section 17A of the Exchange Act.

DTC was created to hold securities for its participants and to facilitate the clearance and settlement of securities transactions between its participants through electronic book-entry changes to the accounts of its participants. DTC's participants include securities brokers and dealers, including the initial purchasers; banks and trust companies; clearing corporations; and certain other organizations. Indirect access to DTC's system is also available to others such as banks, brokers, dealers and trust companies; these indirect participants clear through or maintain a custodial relationship with a DTC participant, either directly or indirectly. Investors who are not DTC participants may beneficially own securities held by or on behalf of DTC only through DTC participants or indirect participants in DTC (including Euroclear or Clearstream).

So long as DTC or its nominee is the registered owner of a Global Note, DTC or its nominee will be considered the sole owner or holder of the Notes represented by that Global Note for all purposes under the Indenture. Except as provided below, owners of beneficial interests in a Global Note:

- (i) will not be entitled to have Notes represented by the Global Note registered in their names;
- (ii) will not receive or be entitled to receive physical, certificated Notes; and
- (iii) will not be considered the registered owners or holders of the Notes under the Indenture for any purpose, including with respect to the giving of any direction, instruction or approval to the trustee under the Indenture.

As a result, each investor who owns a beneficial interest in a Global Note must rely on the procedures of DTC to exercise any rights of a holder of Notes under the Indenture (and, if the investor is not a participant or an indirect participant in DTC, on the procedures of the DTC participant through which the investor owns its interest).

Payments of principal, premium, if any, and interest with respect to the Notes represented by a Global Note will be made by the trustee to DTC's nominee as the registered holder of the Global Note. Neither we, the trustee nor any of our respective agents will have any responsibility or liability for the payment of amounts to owners of beneficial interests in a Global Note, for any aspect of the records relating to or payments made on account of those interests by DTC, or for maintaining, supervising or reviewing any records of DTC relating to those interests.

Payments by participants and indirect participants in DTC to the owners of beneficial interests in a Global Note will be governed by standing instructions and customary practices and will be the responsibility of those participants or indirect participants and not of DTC, its nominee or us.

Transfers between participants in DTC will be effected under DTC's procedures and will be settled in same-day funds. Transfers between participants in Euroclear and Clearstream will be effected in the ordinary way under the rules and operating procedures of those systems.

Cross-market transfers between DTC participants, on the one hand, and Euroclear or Clearstream participants, on the other hand, will be effected within DTC through the DTC participants that are acting as depositaries for Euroclear and Clearstream. To deliver or receive an interest in a Global Note held in a Euroclear or Clearstream account, an investor must send transfer instructions to Euroclear or Clearstream, as the case may be, under the rules and procedures of that system and within the established deadlines of that system. If the transaction meets its settlement requirements, Euroclear or Clearstream, as the case may be, will send instructions to its DTC depository to take action to effect final settlement by delivering or receiving interests in the relevant Global Notes in DTC, and making or receiving payment. Euroclear or Clearstream participants may not deliver instructions directly to the DTC depositaries that are acting for Euroclear or Clearstream.

Because of time zone differences, the securities account of a Euroclear or Clearstream participant that purchases an interest in a Global Note from a DTC participant will be credited on the business day for Euroclear or Clearstream immediately following the DTC settlement date. Cash received in Euroclear or Clearstream from the sale of an interest in a Global Note to a DTC participant will be received with value on the DTC settlement date but will be available in the relevant Euroclear or Clearstream cash account as of the business day for Euroclear or Clearstream following the DTC settlement date.

DTC, Euroclear and Clearstream have agreed to the above procedures to facilitate transfers of interests in the Global Notes among participants in those settlement systems. However, the settlement systems are not obligated to perform these procedures and may discontinue or change these procedures at any time. Neither we nor the trustee nor any of our respective agents will have any responsibility for the performance by DTC, Euroclear or Clearstream or their participants of indirect participants of their obligations under the rules and procedures governing their operations.

### **Certificated Notes**

Beneficial interests in the Global Notes may not be exchanged for Notes in physical, certificated form unless:

- (i) DTC notifies us at any time that it is unwilling or unable to continue as depository for the Global Notes and a successor depository is not appointed within 90 days;
- (ii) DTC ceases to be registered as a clearing agency under the Exchange Act and a successor depository is not appointed within 90 days;
- (iii) we, at our option, notify the trustee that we elect to cause the issuance of certificated Notes; or
- (iv) certain other events provided in the Indenture should occur, including the occurrence and continuance of an event of default with respect to the Notes, and a request for such exchange has been made by the holder.

In all cases, certificated Notes delivered in exchange for any Global Note will be registered in the names, and issued in any approved denominations, requested by the depository and will bear a legend indicating the transfer restrictions of that particular Note.

### **Replacement of Notes**

In the event that any Note becomes mutilated, defaced, destroyed, lost or stolen, we will execute and, upon our request, the trustee will authenticate and deliver a new Note, of like tenor and equal principal amount, registered in the same manner, and bearing interest from the date to which interest has been paid on such Note, in exchange and substitution for such Note (upon surrender and cancellation thereof) or in lieu of and substitution for such Note. In the event that such Note is destroyed, lost or stolen, the applicant for a substitute Note will furnish to us and the trustee such security or indemnity as may be required by them to hold each of them harmless, and, in every case of destruction, loss or theft of such Note, the applicant will also furnish to us and the trustee satisfactory evidence of the destruction, loss or theft of such Note and of the ownership thereof. Upon the issuance of any substituted Note, we may require the payment by the registered holder thereof of a sum sufficient to cover any tax or other governmental charge that may be imposed in relation thereto and any other fees and expenses (including the fees and expenses of the trustee) connected therewith.

For information concerning paying agents and transfer agents for any Notes in certificated form, see “Description of the Notes—Basic Terms of Notes.”

## TRANSFER RESTRICTIONS

The Notes have not been registered, and will not be registered, under the Securities Act or any state securities laws, and the Notes may not be offered or sold except pursuant to an effective registration statement or pursuant to transactions exempt from, or not subject to, registration under the Securities Act. Accordingly, the Notes are being offered and sold only:

- in the United States to qualified institutional buyers (as defined in Rule 144A) pursuant to Rule 144A under the Securities Act; and
- outside of the United States, to certain persons, other than U.S. persons, in offshore transactions meeting the requirements of Rule 903 of Regulation S under the Securities Act.

### **Purchasers' Representations and Restrictions on Resale and Transfer**

Each purchaser of the Notes (other than the initial purchasers in connection with the initial issuance and sale of the Notes) and each owner of any beneficial interest therein will be deemed, by its acceptance or purchase thereof, to have represented and agreed as follows:

- (1) it is purchasing the Notes for its own account or an account with respect to which it exercises sole investment discretion and it and any such account is either (a) a qualified institutional buyer and is aware that the sale to it is being made pursuant to Rule 144A or (b) a non-U.S. person that is outside the United States;
- (2) it acknowledges that the Notes have not been registered under the Securities Act or with any securities regulatory authority of any state and may not be offered or sold within the United States or to, or for the account or benefit of, U.S. persons except as set forth below;
- (3) it understands and agrees that the Notes initially offered in the United States to qualified institutional buyers will be represented by a Global Note and that the Notes offered outside the United States pursuant to Regulation S will also be represented by a Global Note;
- (4) it will not offer, sell, pledge or otherwise transfer any of such Notes except (a) to us, (b) to a qualified institutional buyer in compliance with Rule 144A under the Securities Act, (c) in an offshore transaction complying with the requirements of Rule 903 or Rule 904 of Regulation S under the Securities Act, (d) pursuant to an exemption from registration under the Securities Act (if available) or (e) pursuant to a registration statement that has become effective under the Securities Act and in accordance with all applicable securities laws of the states of the United States and other jurisdictions;
- (5) it agrees that it will give to each person to whom it transfers the Notes notice of any restrictions on transfer of such Notes;
- (6) it acknowledges that prior to any proposed transfer of Notes (other than pursuant to an effective registration statement or in respect of Notes sold or transferred either pursuant to (a) Rule 144A or (b) Regulation S) the holder of such Notes may be required to provide certifications relating to the manner of such transfer as provided in the Indenture;
- (7) it acknowledges and agrees (a) that either (i) no assets of a Plan or a non-U.S., governmental or church plan have been used to acquire the Notes or an interest therein or (ii) the purchase, holding and disposition of the Notes or an interest therein by the purchaser do not constitute a non-exempt prohibited transaction under the Employee Retirement Income Security Act of 1974 or Section 4975 of the Code or a violation of similar law, and (b) that it will not sell or otherwise transfer such Notes or any interest therein other than to a purchaser or transferee that is deemed to represent and agree



with respect to its purchase, holding and disposition of such Notes to the same effect as the purchaser's representation and agreement set forth in this paragraph (7);

- (8) it acknowledges that the trustee, registrar or transfer agent for the Notes may not be required to accept for registration or transfer of any Notes acquired by it, except upon presentation of evidence satisfactory to us that the restrictions set forth herein have been complied with;
- (9) it acknowledges that we, the initial purchasers and other persons, will rely upon the truth and accuracy of the foregoing acknowledgements, representations and agreements and agrees that if any of the acknowledgements, representations and agreements deemed to have been made by its purchase of the Notes are no longer accurate, it will promptly notify us and the initial purchasers;
- (10) if it is acquiring the Notes as a fiduciary or agent for one or more investor accounts, it represents that it has sole investment discretion with respect to each such account and it has full power to make the foregoing acknowledgements, representations and agreements on behalf of each account; and
- (11) it is not residing in a jurisdiction considered as non-cooperating (*jurisdicción no cooperante*) or paying for Notes with funds transferred from accounts maintained in jurisdictions considered as non-cooperating, in each case as determined under applicable Argentine law or regulation.

## Legends

The following is the form of restrictive legend that will appear on the face of the Rule 144A Global Note and that will be used to notify transferees of the foregoing restrictions on transfer. This legend will only be removed with our consent.

**“This Note has not been registered under the U.S. Securities Act of 1933, as amended (the “Securities Act”), or any other securities laws. The holder hereof, by purchasing this Note, agrees for the benefit of the Issuer that this Note or any interest or participation herein may be offered, resold, pledged or otherwise transferred only (1) to the issuer and its subsidiaries, (2) so long as this Note is eligible for resale pursuant to Rule 144A under the Securities Act (“Rule 144A”), to a person who the seller reasonably believes is a qualified institutional buyer (as defined in Rule 144A) in accordance with Rule 144A, (3) in an offshore transaction in accordance with Rule 903 or 904 of Regulation S under the Securities Act, or (4) pursuant to an exemption from registration under the Securities Act (if available) or (5) pursuant to an effective registration statement under the Securities Act, and in each of such cases in accordance with any applicable securities laws of any state of the United States or other applicable jurisdiction. The holder hereof, by purchasing this Note, represents and agrees that it will notify any purchaser of this Note from it of the resale restrictions referred to above.**

**This legend may be removed solely in the discretion and at the direction of the issuer.”**

and (ii) the following is the form of restrictive legend which will appear on the face of the Regulation S Global Note and which will be used to notify transferees of the foregoing restrictions on transfer:

**“This Note has not been registered under the U.S. Securities Act of 1933, as amended (the “Securities Act”), or any other securities laws. The holder hereof, by purchasing this Note, agrees that neither this Note nor any interest or participation herein may be offered, resold, pledged or otherwise transferred in the absence of such registration unless such transaction is exempt from, or not subject to, such registration, and in accordance with any applicable securities laws of any other applicable jurisdiction.**

**The foregoing legend may be removed from this Note after 40 days beginning on and including the later of (a) the date on which the Notes are offered to persons other than distributors (as defined in Regulation S under the Securities Act) and (b) the original issue date of this Note.”**

For further discussion of the requirements (including the presentation of transfer certificates) under the Indenture to effect exchanges or transfers of interest in Global Notes and certificated Notes, see “Form of Notes, Clearing and Settlement.”

You acknowledge that we, the initial purchasers and others will rely upon the truth and accuracy of the above acknowledgments, representations and agreements. You agree that if any of the acknowledgments, representations or agreements you are deemed to have made by your purchase of Notes is no longer accurate, you will promptly notify us and the initial purchasers. If you are purchasing any Notes as a fiduciary or agent for one or more investor accounts, you represent that you have sole investment discretion with respect to each of those accounts and that you have full power to make the above acknowledgments, representations and agreements on behalf of each account.

## TAXATION

### General

This section summarizes certain Argentine tax and U.S. federal income tax considerations relating to the purchase, ownership and disposition of the Notes. This summary does not provide a comprehensive description of all tax considerations that may be relevant to a decision to purchase the Notes. This summary does not describe any tax consequences arising under the laws of any state, locality or taxing jurisdiction other than Argentina and the United States.

This summary is based on the tax laws of Argentina and the United States as in effect on the date of this offering memorandum, as well as regulations, rulings and decisions of Argentina and the United States available on or before that date and now in effect. Those laws, regulations, rulings and decisions are subject to change and changes could apply retroactively, which could affect the continued accuracy of this summary.

Prospective purchasers of the Notes should consult their own tax advisors as to the Argentine, United States or other tax consequences of the purchase, ownership and disposition of the Notes or beneficial interests therein. They should especially consider how the tax considerations discussed below, as well as the application of state, local, foreign or other tax laws, could apply to them in their particular circumstances.

### Certain U.S. Federal Income Tax Considerations

The following is a summary of certain U.S. federal income tax consequences of the purchase, ownership and disposition of the Notes as of the date hereof. Except where noted, this summary deals only with Notes that are held as capital assets by a U.S. holder (as defined below) who acquires the Notes upon original issuance at their initial offering price.

A “U.S. holder” means a beneficial owner of the Notes that is for U.S. federal income tax purposes any of the following:

- an individual citizen or resident of the United States;
- a corporation (or any other entity treated as a corporation for U.S. federal income tax purposes) created or organized in or under the laws of the United States, any state thereof or the District of Columbia;
- an estate the income of which is subject to U.S. federal income taxation regardless of its source; or
- a trust if it (1) is subject to the primary supervision of a court within the United States and one or more U.S. persons have the authority to control all substantial decisions of the trust or (2) has a valid election in effect under applicable U.S. Treasury regulations to be treated as a U.S. person.

This summary is based upon provisions of the Internal Revenue Code of 1986, as amended (the “Code”), and regulations, rulings and judicial decisions as of the date hereof. Those authorities may be changed, perhaps retroactively, so as to result in U.S. federal income tax consequences different from those summarized below. This summary does not address all aspects of U.S. federal income taxes and does not address the effects of the Medicare contribution tax on net investment income or foreign, state, local or other tax considerations that may be relevant to you in light of your particular circumstances. In addition, it does not represent a detailed description of the U.S. federal income tax consequences applicable to you if you are subject to special treatment under the U.S. federal income tax laws. For example, this summary does not address:

- tax consequences to holders who may be subject to special tax treatment, such as dealers in securities or currencies, traders in securities that elect to use the mark-to-market method of accounting for their securities, financial institutions, regulated investment companies, real estate investment trusts, partnerships or other pass-through entities for U.S. federal income tax purposes, individual retirement accounts and other tax-deferred accounts, tax-exempt entities or insurance companies;

- tax consequences to persons holding the Notes as part of a hedging, integrated, constructive sale or conversion transaction or a straddle;
- tax consequences to holders of the Notes whose “functional currency” is not the U.S. dollar;
- alternative minimum tax consequences, if any; or
- tax consequences attributable to persons being required to accelerate the recognition of any item of gross income with respect to the Notes as a result of such income being recognized on an applicable financial statement.

If a partnership (or any entity or arrangement treated as a partnership for U.S. federal income tax purposes) holds the Notes, the tax treatment of a partner will generally depend upon the status of the partner and the activities of the partnership. If you are a partner of a partnership holding the Notes, you should consult your tax advisors.

**If you are considering the purchase of Notes, you should consult your own tax advisors concerning the particular U.S. federal income tax consequences to you of the purchase, ownership and disposition of the Notes, as well as the consequences to you arising under other U.S. federal tax laws and the laws of any other taxing jurisdiction.**

### ***Payments of Interest***

Stated interest on a Note (including any Argentine tax withheld) will generally be taxable to you as ordinary income at the time it is paid or accrued in accordance with your regular method of accounting for U.S. federal income tax purposes. In addition to stated interest on the Notes, you will be required to include in income any Additional Amounts (as described under “Description of the Notes—Payments of Additional Amounts”) paid in respect of any Argentine withholding tax. You may be entitled to deduct or credit any Argentine withholding tax, subject to certain limitations (including that the election to deduct or credit foreign taxes applies to all of your foreign taxes for a particular taxable year). Interest income (including any Additional Amounts) on a Note generally will be considered foreign source income and, for purposes of the U.S. foreign tax credit, generally will be considered passive category income. You will generally be denied a foreign tax credit for Argentine or other foreign taxes imposed with respect to the Notes where you do not meet a minimum holding period requirement during which you are not protected from risk of loss. The rules governing the foreign tax credit are complex. You are urged to consult your tax advisors regarding the availability of the foreign tax credit under your particular circumstances.

### ***Sale, Exchange, Retirement or other Taxable Disposition of Notes***

Upon the sale, exchange, retirement or other taxable disposition of a Note, you will recognize gain or loss equal to the difference between the amount you realize thereon (less an amount equal to any accrued but unpaid interest, which will be taxable as interest income to the extent not previously included in income) and your adjusted tax basis in the Note. Your adjusted tax basis in a Note will, in general, be your cost for that Note. Any gain or loss you recognize will generally be capital gain or loss and will generally be long-term capital gain or loss if at the time of the sale, exchange, retirement or other disposition the Note has been held for more than one year. Long-term capital gains of non-corporate U.S. holders (including individuals) are eligible for reduced rates of taxation. The deductibility of capital losses is subject to limitations. Any gain or loss you recognize will generally be treated as U.S. source gain or loss. Consequently, you may not be able to claim a credit for any Argentine or other foreign tax imposed upon a disposition of a Note unless that credit can be applied (subject to applicable limitations) against U.S. federal income tax due on other income treated as derived from foreign sources.

### ***Backup Withholding and Information Reporting***

Generally, information reporting requirements will apply to all payments on the Notes and the proceeds from a sale or other disposition of a Note paid to you, unless you are an exempt recipient. Additionally, if you fail to provide your taxpayer identification number or, in the case of interest payments, fail either to report in full dividend and interest income or to make certain certifications, you may be subject to backup withholding on any such payments or proceeds.

Backup withholding is not an additional tax and any amounts withheld under the backup withholding rules will be allowed as a refund or a credit against your U.S. federal income tax liability, provided the required information is timely furnished to the Internal Revenue Service.

**The above description is not intended to constitute a complete analysis of all tax consequences relating to the ownership of Notes. Prospective purchasers of Notes should consult their own tax advisors concerning the tax consequences of their particular situations.**

### **Certain Argentine Tax Considerations**

The following summary is based on Argentina's tax laws as they are in effect on the date of this offering memorandum and is subject to any changes in Argentine laws that may become effective after such date.

On December 29, 2017, Law No. 27,430 (the "Tax Reform Law") was published in the Official Gazette, which introduces several modifications to the former tax regime. Recently, Decree No. 279/2018 was published in the Official Gazette on April 9, 2018, Decree No. 1170/2018 was published in the Official Gazette on December 27, 2018 and General Resolution (AFIP) No. 4227/2018 was published on April 12, 2018, all of which regulate the Tax Reform Law regarding, among others, the income tax applicable to income obtained by non-Argentine residents derived from financial transactions and yields.

Prospective purchasers of the Notes should consult their own tax advisors as to the Argentine or other tax consequences of the purchase, ownership and disposition of the Notes or beneficial interests therein. They should especially consider how the tax considerations discussed below, as well as the application of state, local, foreign or other tax laws, could apply to them in their particular circumstances.

Argentina has concluded tax treaties with several countries in order to avoid duplication of taxes on income and wealth. In case that an investor resides for tax purposes in one of the countries with tax treaties in force, in principle, its rules will prevail over domestic law and regulations, unless they offer a more favorable treatment than in the relevant treaty.

The following description is based on a reasonable interpretation of the rules in force. However, it cannot be assured that the relevant tax authorities and the courts will agree with each and every one of the comments made here.

### **Income Tax**

#### ***Interest Payments***

In accordance with the Tax Reform Law, which abrogated points 3° and 4° of Article 36 bis of the Negotiable Obligations Law, interest arising from the Notes, obtained by Argentine resident individuals or undivided estates resident in Argentina, are subject to the following treatment for purposes of the income tax:

- In case of Ps. denominated Notes without an adjustment clause, interest payments will be subject to a 5% income tax rate;
- In case of Ps. denominated Notes with an adjustment clause or denominated in foreign currency, interest payments will be subject to a 15% income tax rate.

In case of non-Argentine residents who do not reside in non-cooperative jurisdictions or channel their funds through non-cooperative jurisdictions, interest payments are exempt if the Notes comply with the requirements set forth in Article 36 of the Negotiable Obligations Law.

The Article 36 of the Negotiable Obligations Law conditions that must be complied with in order to apply the exemption are the following:

- the Notes must be placed through a public offering authorized by the CNV;

- the proceeds obtained from the issue of the Notes must be applied either to (i) investments in tangible assets in Argentina, (ii) acquisition of ongoing concern located in Argentina, (iii) working capital in Argentina, (iv) refinancing of debt, (v) capital contributions to controlled or affiliated corporations, (vi) acquisition of capital stock and/or (vii) financing of the ordinary business of the issuer, provided that such proceeds are used only for the purposes set forth in (i), (ii), (iii), (iv), (v) or (vi) above, according to the resolution that approves the issuance of the Notes and the information provided to the investors through this offering memorandum; and
- the issuer must provide evidence to the CNV in the time and manner prescribed by regulations that the proceeds of the issue of the Notes have been used for the purposes described in the bullet point above.

In the event that these conditions are not met, the same income tax rates provided for Argentine resident individuals shall apply to non-Argentine residents on a presumed taxable base of 43% or 100% provided in Article 93 inc. c) sections 1° and 2°, respectively, of the Income Tax Law No. 20,628 (the “Income Tax Law”), depending on the condition of the holder and the issuer, all in accordance with Article 3° of General Resolution AFIP No. 4227/2018.

Second unnumbered following Article 15 of the Income Tax Law defines “non-cooperative jurisdictions” as those countries or jurisdictions that have not entered into an exchange of information for tax purposes agreement or non-double taxation treaty with Argentina with a broad exchange of information clause, as well as those countries that having entered into such agreements, do not effectively comply with the exchange of information provisions.

The agreements and conventions mentioned in the previous paragraph must comply with the international standards of fiscal transparency and information exchange regarding fiscal matters to which Argentina has committed itself. It is also provided that the Argentine government will draw up a list of non-cooperative jurisdictions, provided, however that Article 7° of Decree 279/2018 establishes that until the Argentine government issues the “cooperative” or “non-cooperative” list, the current list published by the AFIP within the framework of Decree 589/2013 must be considered to determine whether a jurisdiction is deemed cooperative or not.

In the case of non-Argentine residents residing in or that the funds invested are channeled through non-cooperative jurisdictions, interest payments will be subject to the 35% withholding rate provided for in Article 91 of the Income Tax Law, in accordance with the provisions of Article 4° of Decree 279/2018. Such rate will apply on a presumed taxable base of 43% or 100% provided in Article 93 inc. c) sections 1° and 2°, respectively, of the Income Tax Law, depending on the condition of the holder and the issuer, all in accordance with the provisions of Article 10 of General Resolution AFIP No. 4227/2018.

The General Resolution AFIP No. 4227/2018 (published in the Official Gazette on April 12<sup>th</sup> 2018) regulates the income tax withholding regime applicable to interest paid to non-Argentine residents. Interest paid to entities incorporated or registered under Argentine law, local branches of foreign entities, sole proprietorships and individuals that carry out certain commercial activities in Argentina, are taxed at a 30% rate for the financial years as from January 1, 2018 until December 31, 2019, and are taxed at a 25% rate for the financial years from January 1, 2020, onwards.

### ***Sale, Exchange, Retirement or Other Disposition of the Notes***

The Tax Reform Law provides that the disposition of Notes by Argentine resident individuals and undivided estates resident in Argentina is subject to the following income tax rates:

- 5% in the case of Ps. denominated Notes without an adjustment clause;
- 15% in the case of (a) Ps. Denominated Notes with an adjustment clause; or (b) foreign currency denominated Notes.

The result from the sale or other form of disposition of the Notes by non-Argentine residents not residing in non-cooperative jurisdictions or whose funds were not channeled through such jurisdictions is exempted from income tax if the Notes comply with the requirements of Article 36 of the Negotiable Obligations Law as described above. In the event that the conditions of the aforementioned Article 36 of the Negotiable Obligations Law are not met, the same

rates provided for Argentine resident individuals are applicable to non-Argentine residents, on a presumed taxable base of 90% provided in Article 93 inc. h) of the Income Tax Law in accordance with the provisions of Article 9 of General Resolution AFIP No. 4227/2018. The option provided for in Article 93 of the Income Tax Law is also applicable.

In the case of non-Argentine residents residing in, or that the funds invested were channeled through a non-cooperative jurisdictions, the result from the sale or other form of disposition of the Notes will be subject to the 35% withholding provided for in Article 91 of the Income Tax Law according to the provisions of Article 4 of Decree 279/2018, on the presumed taxable base set forth Article 93 inc. h) of the Income Tax Law in accordance with the provisions of Article 3 of Decree 279/2018 and Article 10 of General Resolution AFIP No. 4227/2018.

The General Resolution (AFIP) No. 4227/2018 regulates, among other aspects, the income tax withholding regime applicable with respect to non-Argentine residents holding the Notes.

The gain resulting from the sale or disposition of the Notes by entities incorporated or registered under Argentine law, local branches of foreign entities, sole proprietorships and individuals that carry out certain commercial activities in Argentina, are taxed at a 30% rate for the financial years commencing as from January 1, 2018 until December 31, 2019 and at a 25% rate for the financial years beginning from January 1, 2020.

### **Tax on Personal Assets**

Individuals domiciled in Argentina and undivided estates located in Argentina are subject to personal asset tax (“PAT”) with respect to certain assets (such as the Notes) of which they were holders as of December 31 of each year, when their total value exceeds in the aggregate the total amount of Ps. 2,000,000 for the fiscal year ended December 31, 2019 and subsequent periods. Individuals and undivided estates located abroad are only subject to PAT in relation to their assets located in Argentina.

This tax is applicable on the market value of the Notes (in case they are listed on the stock market) or on the acquisition cost plus interest and exchange differences accrued and unpaid (in case they are not listed on the stock market). The tax to be paid by individuals resident in Argentina or undivided estates located in Argentina will be calculated over the aggregate value of the taxable personal assets existing as of December 31 of each year, in excess of Ps. 2,000,000, excluding shares in the capital of any type of company ruled by Law 19,550, with the exception of companies and sole proprietorships.

Since 2019, Law No 27.480 has set the following progressive scale when the assets exceed the total amount of Ps. 2,000,000:

Total Amount of Assets that exceed the minimum taxable threshold		Pay fixed amount	Plus additional percentage of:	Additional percentage is calculated on the excess above
From	Up to Ps.			
Ps. 0	Ps. 3,000,000	Ps. 0	0.25%	Ps. 0
Ps. 3,000,000	Ps. 18,000,000	Ps. 7,500	0.50%	Ps. 3,000,000
Ps. 18,000,000	-	Ps. 82,500	0.75%	Ps. 18,000,000

The individuals domiciled abroad and the undivided estates located abroad will be subject to the rates described in the previous paragraph for the assets located in Argentina. However, no tax will be due if the amount of such tax is equal or less than Ps. 255.75.

Although the Notes owned by individuals domiciled or undivided estates located outside Argentina are technically levied with the personal asset tax, the relevant law (Law No. 23,966 in its relevant part, as amended) and its regulatory decree (Decree No. 127/96, as amended) have not established any procedure for the collection of such tax when the assets are owned directly by such individuals or undivided estates. The “obliged substitute” regime established by the first paragraph of Article 26 (local subject domiciled or based in the country that has the disposition, possession, custody or deposit of Notes) is not applicable to the holding of Notes (fourth paragraph of Article 26 of Personal Property Tax Law No. 27,260).

Notes held as of December 31 of each year by corporations and other entities which are not organized or incorporated in Argentina (other than the Argentine branches and permanent establishments thereof) will generally be conclusively presumed to be indirectly owned by individuals or undivided estates located in Argentina and, accordingly, subject to the PAT. However, such a non-Argentine corporation or other foreign entity will not be subject to the PAT if (i) the Notes held by such corporation or other entity are authorized by the CNV for public offering in Argentina and “traded” in one or more Argentine or non-Argentine securities markets, (ii) the capital stock of such corporation or other entity is not in bearer form, (iii) the principal activity of such corporation or other entity does not consist of investing outside its jurisdiction of organization or incorporation and such corporation or other entity is not generally restricted from doing business in the jurisdiction of organization or incorporation, or (iv) such corporation or other entity is an exempt entity (i.e., insurance company, pension fund, mutual fund or bank or financial institution organized in a country in which the relevant central bank applies the standards approved by the Basel Convention).

In the case of non-Argentine corporations and other foreign entities presumed to be indirectly owned by Argentine individuals or undivided estates as described above and that are subject to the PAT, the tax will be determined by applying the current tax rate in each fiscal period increased by 100%, on the acquisition cost plus accrued and unpaid interest, and we will be responsible as a substitute obligor for paying such tax. In the event that a non-Argentine corporation or other entity holding Notes is exempt from the PAT for any reason other than the fact that the Notes are authorized by the CNV for public offering in Argentina and traded in one or more Argentine or non-Argentine securities markets, we will nevertheless be responsible for paying the tax in case the public offering exemption is not applicable, unless we actually obtain on a timely basis due certificates as to the non-taxable or exempt status of such corporation or other entity.

On the other hand, Decree 127/96 establishes that such legal presumption will not be applicable to private debt securities and shares whose public offering has been authorized by the CNV and that are traded on stock exchange markets located in Argentina or abroad. In order to establish the non-application of this legal presumption and, therefore, that the Argentine private issuer should not act as a “substitute obligor”, we will maintain in our records a duly certified copy of the resolution of the CNV authorizing the public offering of the Notes, and the proof that this certificate was in force as of December 31 of the fiscal year in which the tax liability occurred, as established in Resolution No. 2151/2006 of the AFIP. In the event that the Argentine Treasury deems that it does not have the proper documentation to probe the authorization of the CNV and the trading of the Notes in securities markets located in Argentina or abroad, we will be responsible for the payment of the PAT.

### **Value Added Tax (VAT)**

Interest payments made in respect of the Notes will be exempt from VAT to the extent that the Notes are issued in a public offering authorized by the CNV. Likewise, as long as the Notes comply with the conditions of Article 36 of the Negotiable Obligations Law, any benefit related to the offer, subscription, signature subscription, transfer, authorization or cancellation of the Notes will be exempt from VAT in Argentina.

### **Presumed Minimum Income Tax**

Under Law No. 27,260, the PMIT was repealed effective on January 1, 2019.

### **Tax on Bank Debit and Credits**

Law 25,413 establishes that money amounts paid through bank checking accounts in Argentine banks are subject to a 0.6% tax on bank debits and credits (“TDC”). In certain cases, an increased rate of 1.2% and a reduced rate of 0.075% may apply. Any payments deposited in saving accounts are exempt, in principle, from this tax. The tax is withheld by the banking institution.

The movement of funds in some special checking accounts is exempt from this tax (Central Bank Communication “A” 3250), when such accounts have been created in the name of foreign legal entities, and to such an extent as they are solely used to make financial investments in Argentina (see Section 10, paragraph (s), of the annex to Executive Decree No. 380/2001).



In accordance with Law No. 27,432 (published in the Official Gazette on December 29, 2017), the TDC shall be extended up to December 31, 2022, inclusive. Additionally, the abovementioned law established that the Executive Power may increase up to 20% per year the percentages of the TDC payments that can be accounted for as payment on account of Argentine income tax. Additionally, this law enables the Executive Power to establish in 2022 that the amounts paid as TDC may be fully creditable against Argentine income tax.

According to Decree 409/2018 (Published in the Official Gazette on May 7, 2018) the owners of bank accounts on which the tax is levied at the 0.6% or 1.2% rate may compute 33% of the amounts paid under this tax as a payment on account of the income tax, PMIT and/or the special contribution on cooperative capital. The amount not computed may not be subject, under any circumstances, to compensation with other taxes borne by the taxpayer or requests for reimbursement or transfer in favor of third parties, and may be transferred, until exhaustion, to other fiscal periods of the aforementioned taxes. The amount computed as a tax credit cannot be deducted for purposes of determining the income tax.

### **Tax on Gross Income**

Investors who carry out activities on a regular basis or who are presumed to carry out such activities in any jurisdiction in which they obtain interest income derived from the holding of Notes, or from their sale or transfer, may be subject to gross income tax. This tax is a provincial tax and its rules may vary from one province to another.

The general rate applied varies depending on the jurisdiction, but, in general terms the rates applied are between 0.01% and 8%, varying according to certain taxpayer groups and categories.

Some provincial jurisdictions, such as the City of Buenos Aires and the Province of Buenos Aires, establish that the income resulting from any transaction related to notes issued in accordance with the Negotiable Obligations Law is exempt from the gross income tax to the extent that the exemption from income tax applies.

Potential investors should analyze the possible incidence of the tax on gross income in light of the applicable regulations that may be relevant depending on their residence and economic activity.

### **Stamp Taxes**

The stamp tax taxes the instrumentation of acts, contracts and transactions in the territory of each province and the City of Buenos Aires, or contracts of those who are instrumented in one of the mentioned jurisdictions and produce effects in the territory of another jurisdiction.

The instruments, acts and operations related to the issuance of securities representing debt of their issuers and any other securities subject to a public offering under the terms of the Argentine Capital Markets Law, are also exempt from the tax in the City of Buenos Aires and in the Province of Buenos Aires. This exemption also covers the guarantees related to such emissions. However, the exemption is void if within 90 days no authorization is requested for the public offering of such securities to the CNV and / or if the placement of the securities is not carried out within 180 days following the granting of the requested authorization.

The potential holders of the Notes must consider the possible incidence of this tax in the different jurisdictions of the country in relation to the issuance, subscription, placement and transfer of the Notes.

Pursuant to Law 27,429 of “Fiscal Consensus” (BO January 2, 2018) the provinces that adhere to said law commit themselves to establish, for certain acts or contracts, a maximum stamp tax rate of 0.75% as of January 1, 2019, 0.5% as of January 1, 2020, 0.25% as of January 1, 2021 and to eliminate the stamp tax as of January 1, 2022.

So far the following Argentine provinces have adhered to Law 27,429: Province of Buenos Aires, City of Buenos Aires, Catamarca, Chaco, Chubut, Córdoba, Corrientes, Entre Ríos, Formosa, Jujuy, La Rioja, Mendoza, Misiones, Neuquén, Río Negro, Salta, Santa Cruz, Santa Fe, Santiago del Estero and Tucumán.

## **Provincial Collection Regimes on Credits in Bank Accounts**

Different provincial tax authorities (e.g., Corrientes, Córdoba, Tucumán, City of Buenos Aires, Province of Buenos Aires, Salta, etc.) have established advance payment regimes regarding the “gross income tax” that are, in general, applicable to credits generated in bank accounts opened at financial institutions governed by the “Financial Institutions Law”.

These regimes apply to local taxpayers that are included in a list distributed, usually on a monthly basis, by the provincial tax authorities to the financial institutions aforementioned.

Tax rates applicable depend on the regulations issued by each provincial tax authority, in a range that, currently, could amount up to 5%. For taxpayers subject to these advance payment regimes, any payment applicable qualifies as an advance payment of the “gross income tax”.

## **Free Transfer Tax**

In the City of Buenos Aires, the free transmission of goods to heirs, legatees or grantees, is not taxed.

At the provincial level, the Province of Buenos Aires established, as of January 1, 2011, through Law No. 14,044 and its amendments, the Tax on the Free Transfer of Goods (the “ITGB”).

The individuals and legal entities that are beneficiaries of a free transfer of goods will be levied with this tax as long as they reside in the relevant province, regardless of where the assets are located. The applicable rates vary between 1.6% and 8.78% depending on the degree of kinship and the amount of the taxable base. The Notes, insofar as they are involved in a free transfer of assets, could be affected by these taxes in the indicated jurisdictions.

Regarding the existence of a similar tax in the other provincial jurisdictions, the analysis should be carried out taking into consideration the applicable legislation in each province.

## **Public Offer and Tax Exemptions**

The Negotiable Obligations Law requires that securities be placed through a public offering in order to qualify for the preferential tax treatment contemplated therein. Accordingly, the CNV established the minimum guidelines governing a primary placement of marketable securities under the CNV Rules.

The main minimum guidelines for primary placement of marketable securities are as follows:

- Publication of the final version of the offering memorandum and any other supplementary documents required by the CNV Rules for the type of marketable securities involved, prior to the commencement of the process, with the following minimum information: (i) type of instrument, (ii) amount or number so offered, specifying whether it is a fixed amount or a range subject to minimum and maximum limits, (iii) minimum trading unit of the instrument; price (specifying whether it is fixed value or a range subject to minimum and maximum limits) and multiples, (iv) due date or maturity, (v) repayment, (vi) trading form, (vii) primary trading commission, (viii) information about dates and times of the auction or public tender, (ix) determination of variables, which may include price competition, interest rate, yield or other variables, and the form of offer pro rating, if necessary, (x) all registered dealers and settlement and clearing agents may have access to the system to submit offers, (xi) the public tender process may be, at the issuer’s option, blind (“sealed offers” where no participant, including dealers, shall have access to the offers submitted until the auction period is completed), or open (i.e. the offers are disclosed as they are submitted to the tender system), (xii) upon expiration of the period for receipt of offers, the submitted offers may not be modified nor shall any new offers be submitted, and (xiii) the offering memorandum and the supplementary documents shall be published through the application known as Autopista de la Información Financiera, on the website of the exchange markets and the issuer’s institutional webpage. Issuers are required to prepare the offering memorandums describing in detail any placement efforts to

be used and to provide evidence of performance, if requested by the relevant authorities. The Notes shall not be deemed to be tax exempt solely upon securing the CNV's authorization of a public offering.

- The offer may be executed pursuant to an underwriting agreement. In such case, it is valid for the purpose of considering the fulfillment of the public offer requirement, if the placing agent made the placement efforts as indicated in article 3 of Chapter IV of Title VI of the CNV Rules.

### **Restriction Regarding Countries with Low or no Taxation**

Pursuant to Tax Proceedings Law No. 11,683 (as amended by Law No. 25,795) published in the Official Gazette on November 17, 2003 funds brought into Argentina from countries considered to be “no or low tax jurisdictions,” regardless of the nature or type of transaction, shall be deemed as unjustified net worth increases stemming from undeclared income of the local receiver of the funds.

In such cases, the amount of the unjustified net worth increases plus 10% for non-deductible expenses or spent income is subject to income tax, VAT and internal taxes, as the case may be, in the fiscal year in which the unjustified net worth was generated.

According to the third Article without number incorporated after Article 15 of the Income Tax Law “low or no tax jurisdictions” are defined as countries, domains, jurisdictions, territories, associated states or other special tax regimes in which the maximum corporate income tax rate is lower than 60% of the corporate income tax rate established in Section 69 A) of the Income Tax Law, according to Article 86 d) of the Tax Reform Law. The executive branch of Argentina has the obligation to publish the list of non-cooperative jurisdictions. Such list has not been issued yet. However, National Decree No. 279/2018 -as a transitional regulation- provides that, until such list is published, any jurisdiction not included in the current list of “cooperative jurisdictions” published by the AFIP within the framework of National Decree No. 589 date on May 27, 2013 will be deemed as “non-cooperative.” Such list is available on the AFIP's website.

In turn, Article 21 of Decree 1344/1998 (as amended by Decree 1170/2018) provides that, for purposes of determining the taxation level referred to in the third unnumbered Article following Article 15 of the Income Tax Law, subjects of income tax must consider the total tax rate that applies in each jurisdiction in which the subject's income is taxed, irrespective of the level of government that set such rate. Additionally, the aforementioned Article establishes that a “special tax regime” will be construed to mean any regulation or scheme which varies from the general corporate income tax regime that is in force in a given country, and whose effect is to provide a lower tax rate than the general corporate income tax regime.

The Argentine tax resident may rebut such legal presumption by duly evidencing before the AFIP that the funds arise from activities effectively performed by the Argentine taxpayer or by a third party in such jurisdictions, or that such funds have been previously declared.

According to Section 82 of the Tax Reform Law, for fiscal purposes, any reference to “non-cooperative jurisdictions” or “low or no tax jurisdictions” should be understood to be “non-cooperative jurisdictions or low or no tax jurisdictions,” as defined in the second and third sections added following section 15 of the Income Tax Law, and its amendments.

This offering memorandum shall not constitute an offer to sell, and/or an invitation to formulate purchase offers, of the Notes: (i) in those jurisdictions in which the execution of such offer and/or invitation was not allowed by the applicable regulations; (ii) for those persons or entities domiciled, incorporated or residents of a country considered as a “low or no tax jurisdiction”, or for those persons or entities that, for the acquisition of the Notes, use a localized or open account in a country considered as a “low or no tax jurisdiction”.

Each investor must comply with all the regulations in force in any country in which it purchases, offers and/or sells the Notes and/or in which it owns and/or distributes the offering memorandum and the investors must obtain the consents, the approvals and/or permits for the purchase, offer and/or sale of the Notes required by the applicable regulations in any such country to which they are subject and/or in which they made such purchases, offers and/or

sale. Neither we nor the initial purchasers that are designated by us, will have any responsibility for breaches of said regulations. The investor must assume that the information contained in this offering memorandum is accurate as of the date of the front page of the present, and not to any other date.

#### **Court Fee**

In case it is necessary to institute judicial enforcement proceedings in relation to the Notes in Argentina, a court fee (currently 3%) will be imposed on the amount of any claim initiated before the Argentine courts with a seat in the City of Buenos Aires.

## PLAN OF DISTRIBUTION

Subject to the terms and conditions set forth in the purchase agreement relating to the Notes to be entered with the initial purchasers referred to below, each initial purchaser has severally agreed to purchase, and we have agreed to sell to the initial purchasers, the principal amount of the Notes set forth opposite such initial purchaser's name in the following table.

<b>Initial Purchasers</b>	<b>Principal Amount of Notes</b>
Citigroup Global Markets Inc. ....	US\$133,334,000
HSBC Securities (USA) Inc. ....	US\$133,333,000
Itau BBA USA Securities, Inc. ....	US\$133,333,000
Total .....	US\$400,000,000

In addition, pursuant to the Argentine public offering of the Notes, the Local Placement Agents (as defined below) arranged the placement of the Notes under a local placement agreement.

The purchase agreement provides that the obligations of the initial purchasers are subject to certain conditions precedent, including the absence of any pending or threatened litigation in connection with this offering. The initial purchasers must purchase all the Notes if they purchase any of the Notes. The initial purchasers may offer and sell the Notes through certain of their respective affiliates.

Application will be made to have the Notes listed on the Luxembourg Stock Exchange for trading on the Euro MTF market and listed on the MAE. The Notes do not have an established trading market, so we cannot assure you to the liquidity, development or continuation of the trading markets for the Notes. In addition, any such market-making activity will be subject to the limits imposed by the Securities Act, the Exchange Act, Argentine Law No. 26,831 and the CNV Rules. Accordingly, we cannot assure you as to the liquidity of, or the development or continuation of trading markets for, the Notes.

The initial purchasers may engage in stabilizing and similar transactions that stabilize the price of the Notes in accordance with applicable law. These transactions may consist of bids or purchases for the purpose of pegging, fixing or maintaining the price of the Notes. If an initial purchaser creates a short position in the Notes (that is, if it sells the Notes in an aggregate principal amount exceeding that set forth in this offering memorandum), such initial purchaser may reduce that short position by purchasing the Notes in the open market. In general, purchase of the Notes for the purpose of stabilization or to reduce a short position could cause the price of the Notes to be higher than it might be in the absence of such purchases. All stabilization activities shall be made in accordance with applicable laws.

Neither we nor the initial purchasers make any representation or prediction as to the direction or magnitude of any effect that the transactions described in the immediately preceding paragraphs may have on the price of the Notes. In addition, neither we nor the initial purchasers make any representation that the initial purchasers will engage in any such transactions or that such transactions, once commenced, will not be discontinued without notice.

Certain of the initial purchasers and/or their respective affiliates may enter into derivative and/or structured transactions with clients, at their request, in connection with the Notes and certain of the initial purchasers and/or their respective affiliates may also purchase some of the Notes to hedge their risk exposure in connection with such transactions. Also, certain of the initial purchasers and/or their respective affiliates may acquire for their own proprietary account the Notes. Such acquisitions may have an effect on demand and the price of the offering.

We have agreed to indemnify the initial purchasers and the Local Placement Agents against certain liabilities (including, without limitation, liabilities under the Securities Act) or to contribute to payments the initial purchasers may be required to make in respect thereof. We have also agreed to reimburse the initial purchasers and the Local Placement Agents for certain other expenses.

We expect that delivery of the Notes will be made to investors on or about July 25, 2019, which will be the fifth business day following the date of this offering memorandum (such settlement being referred to as “T+5”). Under Rule 15c6 1 under the U.S. Securities Exchange Act of 1934, trades in the secondary market are required to settle in two business days, unless the parties to any such trade expressly agree otherwise. Accordingly, purchasers who wish to trade Notes on a day prior to the second business day before the date of initial delivery of the Notes hereunder will be required, by virtue of the fact that the Notes initially settle in T+5, to specify an alternate settlement arrangement at the time of any such trade to prevent a failed settlement. Purchasers of the Notes who wish to trade the Notes prior to their date of delivery hereunder should consult their advisors.

The initial purchasers and the Local Placement Agents have, directly or indirectly, performed investment and/or commercial banking or financial advisory services for us and our affiliates, for which they have received customary fees and commissions, and they expect to provide these services to us and our affiliates in the future, for which they also expect to receive customary fees and commissions.

In addition, in the ordinary course of their business activities, the initial purchasers and their affiliates may make or hold a broad array of investments and actively trade debt and equity securities (or related derivative securities) and financial instruments (including bank loans) for their own account and for the accounts of their customers. Such investments and securities activities may involve securities and/or instruments of ours or our affiliates. The initial purchasers and their affiliates may also make investment recommendations and/or publish or express independent research views in respect of such securities or financial instruments and may hold, or recommend to clients that they acquire, long and/or short positions in such securities and instruments with us.

### **European Economic Area**

This offering memorandum has been prepared on the basis that any offer of Notes in any Member State of the European Economic Area will be made pursuant to an exemption under the Prospectus Directive from the requirement to publish a prospectus for offers of Notes. Accordingly any person making or intending to make an offer in that Member State of Notes which are the subject of the offering contemplated in this offering memorandum may only do so in circumstances in which no obligation arises for the Issuer or any of the initial purchasers to publish a prospectus pursuant to Article 3 of the Prospectus Directive in relation to such offer. Neither the Issuer nor the initial purchasers have authorized, nor do they authorize, the making of any offer of Notes in circumstances in which an obligation arises for the Issuer or the initial purchasers to publish a prospectus for such offer. Neither the Issuer nor the initial purchasers have authorized, nor do they authorize, the making of any offer of Notes through any financial intermediary, other than offers made by the initial purchasers, which constitute the final placement of the Notes contemplated in this offering memorandum.

For the purpose of the above provisions, the expression “Prospectus Directive” means Directive 2003/71/EC (as amended, including by Directive 2010/73/EU), and includes any relevant implementing measure the Member State concerned.

The Notes are not intended to be offered, sold or otherwise made available to, and should not be offered, sold or otherwise made available to, any retail investor in the European Economic Area. For the purposes of this provision, the expression, “retail investor” means a person who is one (or more) of the following: (i) a “retail client” as defined in point (11) of Article 4(1) of MiFID II; (ii) a “customer” within the meaning of the IDD, where that customer would not qualify as a professional client as defined in point (10) of Article 4(1) of MiFID II; or (iii) not a “qualified investor” as defined in the Prospectus Directive. Consequently, no key information document required by the “PRIIPs Regulation for offering or selling the Notes or otherwise making them available to retail investors in the European Economic Area has been prepared and therefore offering or selling the Notes or otherwise making them available to any retail investor in the European Economic Area may be unlawful under the PRIIPs Regulation.

Each person in a Member State of the European Economic Area who receives any communication in respect of, or who acquires any Notes under, the offers contemplated in this offering memorandum, or to whom the Notes are otherwise made available, will be deemed to have represented, warranted, acknowledged and agreed to and with each initial purchaser and the Issuer that it and any person on whose behalf it acquires Notes is: (1) a “qualified investor” within the meaning of the law in that Member State implementing Article 2(1)(e) of the Prospectus Directive; and (2) not a “retail investor” as defined above.

Any distributor subject to MiFID II subsequently offering, selling or recommending the Notes is responsible for undertaking its own target market assessment in respect of the Notes and determining the appropriate distribution channels.

These selling restrictions are in addition to any other selling restrictions set out in this offering memorandum.

### **United Kingdom**

This document is for distribution only to persons who: (i) are outside the United Kingdom; (ii) have professional experience in matters relating to investments falling within Article 19(5) of the Financial Services and Markets Act 2000 (Financial Promotion) Order 2005 (as amended, the “Financial Promotion Order”); (iii) are persons falling within Articles 49(2)(a) to (d) (“high net worth companies, unincorporated associations, etc.”) of the Financial Promotion Order; or (iv) are persons to whom an invitation or inducement to engage in investment activity (within the meaning of section 21 of the Financial Services and Markets Act 2000, as amended) in connection with the issue or sale of any Notes may otherwise lawfully be communicated or caused to be communicated (all such persons together being referred to as “relevant persons”). This document is directed only at relevant persons and must not be acted on or relied on by persons who are not relevant persons. Any investment or investment activity to which this document relates is available only to relevant persons and will be engaged in only with relevant persons.

### **Canada**

The Notes may be sold only to purchasers purchasing, or deemed to be purchasing, as principal that are accredited investors, as defined in National Instrument 45-106 Prospectus Exemptions or subsection 73.3(1) of the Securities Act (Ontario), and are permitted clients, as defined in National Instrument 31-103 Registration Requirements, Exemptions and Ongoing Registrant Obligations. Any resale of the Notes must be made in accordance with an exemption from, or in a transaction not subject to, the prospectus requirements of applicable securities laws in Canada.

Securities legislation in certain provinces or territories of Canada may provide a purchaser with remedies for rescission or damages if this offering memorandum (including any amendment hereto) contains a misrepresentation, provided that the remedies for rescission or damages are exercised by the purchaser within the time limit prescribed by the securities legislation of the purchaser’s province or territory. The purchaser should refer to any applicable provisions of the securities legislation of the purchaser’s province or territory for particulars of these rights or consult with a legal advisor.

Pursuant to section 3A.3 (or, in the case of securities issued or guaranteed by the government of a non-Canadian jurisdiction, section 3A.4) of National Instrument 33-105 Underwriting Conflicts (“NI 33-105”), the initial purchasers are not required to comply with the disclosure requirements of NI 33-105 regarding underwriter conflicts of interest in connection with this offering.

### **Chile**

The offer of the Notes is subject to General Rule No. 336 of the Chilean Securities and Insurance Commission (Superintendencia de Valores y Seguros de Chile, or the “SYS”). The commencement date of this offering is the one set forth in the cover page of this offering memorandum. The Notes will not be registered in the Securities Registry (Registro de Valores) or in the Foreign Securities Registry (Registro de Valores Extranjeros) of the SYS and, therefore, the Notes will not be subject to the supervision of the SYS. As unregistered securities, we are not required to deliver or disclose public information about the Notes in Chile. The Notes cannot and will not be publicly offered in Chile unless they are registered in the Securities Registry (Registro de Valores) or Foreign Securities Registry (Registro de Valores Extranjeros), both kept by the SYS. If the Notes are offered in Chile, they will be offered and sold only pursuant to General Rule 336 of the SYS, an exemption to the registration requirements, or in circumstances that do not constitute a public offer of securities under Chilean law.

*La oferta de los valores se acoge a la Norma de Carácter General N°336 de la Superintendencia de Valores y Seguros de Chile (la “SVS”). La fecha de inicio de la presente oferta es la indicada en la portada de este offering*

*memorandum. Los valores no estarán inscritos en el Registro de Valores o en el Registro de Valores Extranjeros que lleva la SVS, por lo que los valores no estarán sujetos a la fiscalización de la SVS. Por tratarse de valores no inscritos, no existe obligación por parte del emisor de entregar en Chile información pública respecto de los valores. Estos valores no podrán ser objeto de oferta pública en Chile mientras no sean inscritos en el Registro de Valores o el Registro de Valores Extranjeros que lleva la SVS. Si los valores son ofrecidos dentro de Chile, serán ofrecidos y colocados sólo de acuerdo a la Norma de Carácter General N°336 de la SVS, una excepción a la inscripción, o en circunstancias que no constituyan una oferta pública de valores en Chile dconformidad a la ley chilena.*

## **Colombia**

The Notes have not been, and will not be, registered in the National Securities and Issuers Registry (*Registro Nacional de Valores y Emisores*) of Colombia or traded on the Colombia Stock Exchange (*Bolsa de Valores de Colombia*). Therefore, the Notes may not be publicly offered or sold in Colombia except in compliance with the applicable Colombian securities regulations.

The offering memorandum is for the sole and exclusive use of the addressee as an offeree in Colombia, and the offering memorandum shall not be interpreted as being addressed to any third party in Colombia or for the use of any third party in Colombia, including any shareholders, administrators or employees of the addressee.

The recipient of the Notes acknowledges that certain Colombian laws and regulations (specifically foreign exchange and tax regulations) are applicable to any transaction or investment made in connection with the Notes being offered and represents that it is the sole party liable for full compliance with any such laws and regulations.

## **Peru**

The Notes and the information contained in this offering memorandum are not being publicly marketed or offered in Peru and will not be distributed or caused to be distributed to the general public in Peru. Peruvian securities laws and regulations on public offerings will not be applicable to the offering of the Notes and therefore, the disclosure obligations set forth therein will not be applicable to the issuer or the sellers of the Notes before or after their acquisition by prospective investors. The Notes and the information contained in this offering memorandum have not been and will not be reviewed, confirmed, approved or in any way submitted to the Peruvian Superintendency of Capital Markets (*Superintendencia del Mercado de Valores*, or “SMV”), and the Notes have not been registered under the Securities Market Law (*Ley del Mercado de Valores*) or any other Peruvian regulations. Accordingly, the Notes cannot be offered or sold within Peruvian territory except to the extent any such offering or sale qualifies as a private offering under Peruvian regulations and complies with the provisions on private offerings set forth therein.

## **Hong Kong**

The Notes may not be offered or sold in Hong Kong by means of any document other than (i) to “professional investors” as defined in the Securities and Futures Ordinance (Cap. 571 of the Laws of Hong Kong) (the “SFO”) and any rules made thereunder or (ii) in other circumstances which do not result in the document being a “prospectus” as defined in the Companies (Winding Up and Miscellaneous Provisions) Ordinance (Cap. 32 of the Laws of Hong Kong) and which do not constitute an offer to the public within the meaning of that Ordinance; and no advertisement, invitation or document relating to the Notes may be issued or may be in the possession of any person for the purposes of issue (in each case whether in Hong Kong or elsewhere) which is directed at, or the contents of which are likely to be accessed or read by, the public of Hong Kong or otherwise is or contains an invitation to the public (except if permitted to do so under the laws of Hong Kong) other than with respect to Notes which are or are intended to be disposed of only to persons outside Hong Kong or only to “professional investors” as defined in the SFO and any rules made thereunder.

## **Japan**

The Notes have not been and will not be registered under the Financial Instruments and Exchange Law of Japan (Law No. 25 of 1948, as amended) and, accordingly, will not be offered or sold, directly or indirectly, in Japan, or for the benefit of any Japanese Person or to others for re-offering or resale, directly or indirectly, in Japan or to any



Japanese Person, except in compliance with all applicable laws, regulations and ministerial guidelines promulgated by relevant Japanese governmental or regulatory authorities in effect at the relevant time. For the purposes of this paragraph, “Japanese Person” shall mean any person resident in Japan, including any corporation or other entity organized under the laws of Japan.

## **Singapore**

This offering memorandum has not been registered as a prospectus with the Monetary Authority of Singapore. Accordingly, the Notes have not been offered or sold nor have any Notes been caused to be made the subject of an invitation for subscription or purchase and the Notes will not be offered or sold or caused to be made the subject of an invitation for subscription or purchase, and neither this offering memorandum nor any other document or material in connection with the offer or sale, or invitation for subscription or purchase, of the Notes, has been circulated or distributed, nor will it be circulated or distributed, whether directly or indirectly, to any person in Singapore other than (i) to an institutional investor (as defined in Section 4A of the Securities and Futures Act (Chapter 289) of Singapore, as modified or amended from time to time (the “SFA”)) pursuant to Section 274 of the SFA, (ii) to a relevant person (as defined in Section 275(2) of the SFA) pursuant to Section 275(1) of the SFA, or any person pursuant to Section 275(1A) of the SFA, and in accordance with the conditions specified in Section 275 of the SFA, or (iii) otherwise pursuant to, and in accordance with the conditions of, any other applicable provision of the SFA.

Where the Notes are subscribed or purchased under Section 275 of the SFA by a relevant person which is: (a) a corporation (which is not an accredited investor (as defined in Section 4A of the SFA)) the sole business of which is to hold investments and the entire share capital of which is owned by one or more individuals, each of whom is an accredited investor; or (b) a trust (where the trustee is not an accredited investor) whose sole purpose is to hold investments and each beneficiary of the trust is an individual who is an accredited investor, securities or securities-based derivatives contracts (each term as defined in Section 2(1) of the SFA) of that corporation or the beneficiaries’ rights and interest (howsoever described) in that trust shall not be transferred within six months after that corporation or that trust has acquired the Notes pursuant to an offer made under Section 275 of the SFA except: (1) to an institutional investor or to a relevant person, or to any person arising from an offer referred to in Section 275(1A) or Section 276(4)(i)(8) of the SFA; (2) where no consideration is or will be given for the transfer; (3) where the transfer is by operation of law; or (4) as specified in Section 276(7) of the SFA.

### *Singapore Securities and Futures Act Product Classification*

Solely for the purposes of its obligations pursuant to sections 309B(1)(a) and 309B(1)(c) of the Securities and Futures Act (Chapter 289 of Singapore) (the “SFA”), we have determined, and hereby notify all relevant persons (as defined in Section 309A of the SFA) that the Notes are “prescribed capital markets products” (as defined in the Securities and Futures (Capital Markets Products) Regulations 2018) and Excluded Investment Products (as defined in MAS Notice SFA 04-N12: Notice on the S Notice FAA-N16: Notice on Recommendations on Investment Products).

## **Switzerland**

The Notes may not be publicly offered, sold or advertised, directly or indirectly, in, into or from Switzerland and will not be listed on the SIX Swiss Exchange or on any other stock exchange or regulated trading facility in Switzerland. Neither this offering memorandum nor any other offering or marketing material relating to the notes constitutes a prospectus as such term is understood pursuant to Article 652a or Article 1156 of the Swiss Code of Obligations or a listing prospectus within the meaning of the listing rules of the SIX Swiss Exchange or the rules of any other stock exchange or regulated trading facility in Switzerland, and neither this offering memorandum nor any or marketing material relating to the Notes may be publicly distributed or otherwise made publicly available in Switzerland.

## **Argentina**

The Notes are being placed in Argentina to qualified investors, as defined by the CNV Rules, by means of a public offering conducted in accordance with Argentine securities law, the CNV Rules (as amended by Resolution

No. 662/2016 of the CNV) and other applicable Argentine laws (the “Local Offering”). The public offering of the Notes as described in this offering memorandum is included in the public offering authorization granted by the CNV to the Program, pursuant to Section 41, Title II of the Chapter V of the CNV Rules. Neither this offering memorandum nor the Argentine pricing supplement has been previously reviewed by the CNV. In accordance with Section 51 of Title II of Chapter V of the Rules of the CNV, within five business days after the subscription of the Notes, the Issuer will file with the CNV the final documentation related to the Notes. The Local Offering will be made by way of an Argentine prospectus in the Spanish language with information substantially similar to that included in the offering memorandum.

Banco Itaú Argentina S.A. and Itaú Valores S.A. (together, the “Local Placement Agents”) and the Company will enter into a placement agreement (*contrato de colocación*) governed by Argentine Law, pursuant to which the Local Placement Agents may only solicit or receive Expressions of Interest (as defined below) from investors who are Argentine residents and place them in the order book maintained by the Initial Purchasers through a book building process outside Argentina.

The Initial Purchasers and the Local Placement Agents will engage in marketing efforts and will offer the Notes by means of a public offering in Argentina pursuant to Argentine securities laws, the CNV Rules and other applicable Argentine laws, including, without limitation, Chapter IV, Title VI of the CNV Rules. In addition, they will undertake marketing efforts for the placement of the Notes to investors outside Argentina in accordance with the laws of the applicable jurisdictions.

The Local Placement Agents’ and the Initial Purchasers’ placement efforts will consist of a variety of marketing methods and activities customarily undertaken in transactions of this type. Such marketing efforts may include: (i) international and/or local road shows with institutional investors; (ii) calls with institutional investors, where such investors will have the opportunity to ask questions regarding our business and the Notes; (iii) electronic road shows; (iv) the publication of a summary of the Argentine prospectus (containing information substantially similar to that included in this offering memorandum) in the MAE bulletin and the publication of other notices in newspapers and bulletins; (v) the distribution (electronically or in hard copy) of this offering memorandum outside Argentina, and the Argentine prospectus in Argentina; and (vi) the availability to investors of hard copies of the offering memorandum at the principal offices of the Initial Purchasers.

#### *Book-Building*

The placement of the Notes is being conducted pursuant to book-building procedures undertaken by the Initial Purchasers.

Investors interested in purchasing the Notes must make expressions of interest (each an “Expression of Interest”) specifying the requested principal amount of the Notes that they seek to purchase, which shall be no less than US\$150,000 and in integral multiples of US\$1,000 in excess thereof, as well as the offered yield for the Notes (the “Offered Yield”).

As described further below, the Initial Purchasers will record the Expressions of Interest received from investors outside of Argentina and from the Local Placement Agents in Argentina in an electronic registry book located in New York City in accordance with customary practice for this type of international offering in the United States and applicable regulations pursuant to Article 1, Section I, Chapter IV, Title VI of the CNV Rules, as amended by Resolution CNV No. 662/2016 (the “Register”).

Subject to Argentine securities law, the CNV Rules and other applicable laws and regulations and in compliance with the transparency obligations, the Local Placement Agents and the Initial Purchasers reserve the right to terminate the offering at any time and to reject, in whole or in part, any Expression of Interest containing mistakes or omissions that impede their processing in the system, and to not allocate any Notes or allocate Notes in a lower amount than that requested by the investor in its Expression of Interest in accordance with the allocation procedures described below. In addition, the Initial Purchasers and the Local Placement Agents reserve the right to reject Expressions of Interest for lack of compliance with the requirements of applicable anti-money laundering regulations.

### *Offering Period*

In Argentina, the Expressions of Interest must be made with the Local Placement Agents, who will submit them to the Initial Purchasers in accordance with procedures to be determined by the Initial Purchasers. Subject to the CNV Rules and other applicable regulations, the Local Placement Agents may request that investors in Argentina that make Expressions of Interest provide guarantees for the payment of their requested orders. Outside of Argentina, the Expressions of Interest must be made with the Initial Purchasers.

The Expressions of Interest may only be made with the Initial Purchasers or the Local Placement Agents during the period beginning on or about July 18, 2019 at 10:00 am Buenos Aires time and ending on or about July 18, 2019 (the “Allocation Date”) at 1:00 pm Buenos Aires time (such period, the “Offering Period,” and the date and time of the expiration of the Offering Period, the “Expression of Interest Deadline”). After the Expression of Interest Deadline, no new Expressions of Interest will be accepted.

Between 1:00 pm and 6:00 pm Buenos Aires time on the Allocation Date, the Initial Purchasers shall record in the Register all Expressions of Interest received before the Expression of Interest Deadline and shall thereafter close the Register (the exact date and time of the effective registration of the Expressions of Interest in the Register and closing of the Register determined by the initial purchasers in their sole discretion within the range described above) (the “Register Closing Time”). Any Expressions of Interest received before the Expression of Interest Deadline shall not be binding and may be withdrawn or modified until the Register Closing Time. In accordance with the provisions of Article 7, Section I, Chapter IV, Title VI of the CNV Rules (as amended by Resolution No. 662/2016 of the CNV), investors waive their right to expressly ratify their Expressions of Interest effective as of the Register Closing Time. Accordingly, all Expressions of Interest not withdrawn or modified as of the Register Closing Time shall constitute firm, binding and definitive offers based on the terms presented (as amended at such time) without need for any further action by the investor.

### *Allocation*

On the Allocation Date, after the Register Closing Time, the Issuer, with the advice of the Initial Purchasers, and the Local Placement Agents, will determine, based on the demand received and in accordance with the book-building process, the issue price (the “Issue Price”), the interest rate (the “Applicable Rate”) and the amount of Notes to be issued, in each case based on the Expressions of Interest received and in accordance with the book-building procedures.

In addition, following the final allocation of the Notes on the Allocation Date, the Company will publish a notice announcing the results of the placement of the Notes on the CNV webpage and, as soon as possible thereafter, in the MAE Electronic Bulletin, specifying the amount of the Notes to be issued, the Issue Price and the Applicable Rate (the “Results Notice”).

### *Amendment, Suspension and/or Extension*

The Offering Period may be modified, suspended or extended prior to expiration of the original term, by notice given by the same means by which the original offering was announced. None of the Company, the Local Placement Agents or the Initial Purchasers shall be responsible in the event of a modification, suspension or extension of the Offering Period or of the Allocation Date, and those investors who have submitted Expressions of Interest shall not be entitled to any compensation as a result thereof. In the event the Allocation Date is terminated or revoked or a decision is made not to issue the Notes or proceed with the offering, all Expressions of Interest received will automatically expire.

In the event the Offering Period is suspended or extended, investors that have submitted Expressions of Interest during the Offering Period may, in their sole discretion and without penalty, withdraw such Expressions of Interest at any time during the period of the suspension or the new extended Offering Period.

### *Voided Offers; Rejection of Expressions of Interest*

Expressions of Interest may not be rejected, except where they contain mistakes or omissions that make their processing unduly burdensome or impede their processing in the system, or as further described below.

Those investors who have filed Expressions of Interest must provide to the Local Placement Agents or the Initial Purchasers, as applicable, all information and documentation they may require in order to comply with applicable laws and regulations related to the prevention of anti-money laundering and the financing of terrorism. In cases where the information provided is inadequate, incomplete and/or is not provided in a timely manner, the Local Placement Agents and the Initial Purchasers may, without liability, reject the related Expressions of Interest.

The Local Placement Agents and the Initial Purchasers reserve the right to reject an Expression of Interest if they do not believe that requirements under applicable laws or regulations have been satisfied. Such applicable laws and regulations include those related to anti-money laundering, such as those issued by the UIF, the CNV or the Central Bank. Any decision to reject an Expression of Interest will take into account the principle of equal treatment among investors.

Any modification to these rules will be published for one business day on the CNV's webpage and in the MAE's electronic gazette.

The Company may declare void the placement of the Notes during or immediately following completion of the Offering Period if: (i) no Expressions of Interest have been received or all of the Expressions of Interest have been rejected; (ii) the Offered Yield by investors was higher than that expected by us; (iii) the Expressions of Interest represent a principal amount of the Notes that, being reasonably considered, would not justify the issuance of the Notes; (iv) considering the economics indicated in the Expressions of Interest, the issuance of the Notes will be unprofitable for us; or (v) there were material adverse changes in the international financial markets and/or the local or international capital markets, or in the Company's general condition and/or that of Argentina, including, for example, disruptions in political, economic, financial conditions or our credit, such that the issuance of Notes described within this offering memorandum would not be advisable; or (vi) investors have not complied with laws and regulations related to anti-money laundering and the financing of terrorism, including those issued by the UIF, the CNV and the Central Bank. In addition, the allocation of the Notes may be rescinded in accordance with the terms and conditions of the Purchase Agreement.

### *Allocation Procedures*

Investors with Expressions of Interest indicating an Offered Yield lower than or equal to our applicable yield (the "Applicable Yield") may purchase the Notes, subject to applicable laws, in the allocation decided by the Company, with the advice of the Initial Purchasers and the Local Placement Agents based on the criteria described below.

The Company cannot assure investors that their Expressions of Interest will be allocated nor that, if allocated, they will be allocated the full amount of Notes requested or that the proportion of the allocation of the aggregate amount of Notes requested between two equal Expressions of Interest will be the same.

No investor that submitted an Expression of Interest with an Offered Yield higher than the Applicable Yield determined by the Company shall receive any Notes. None of the Company, the Initial Purchasers or the Local Placement Agents shall have any obligation to inform any investor whose Expression of Interest has been totally or partially excluded that such Expressions of Interest has been totally or partially excluded.

### *Settlement*

The settlement of the Notes will take place on the Notes Issue Date, which will be July 25, 2019 or any other subsequent date provided in the Results Notice. All Notes shall be paid for by the investors on or before the Notes Issue Date in U.S. dollars by wire transfer to an account outside of Argentina to be specified by the Initial Purchasers and/or the Local Placement Agents in accordance with standard market practice.

The investors acquiring the Notes will not be under any obligation to pay any commissions, unless such investor makes the transaction through its broker, agent, commercial bank, trust company or other entity, in which case such investor may have to pay commissions and/or fees to such entities, which shall be such investor's exclusive responsibility. Likewise, in the event of transfers or other acts with respect to the Notes, including changes made through the collective depository system, DTC may charge fees to the participants, which may be passed on to the holders of the Notes.

## **LEGAL MATTERS**

The validity of the Notes and certain legal matters in connection with Argentine law will be passed upon for us by Estudio O'Farrell, our Argentine legal counsel. Certain matters in connection with United States and New York law in connection with the Notes will be passed upon by Simpson Thacher & Bartlett LLP, our United States legal counsel. Legal matters will be passed upon for the initial purchasers by Tanoira Cassagne Abogados, Argentine legal counsel to the initial purchasers, and Shearman & Sterling LLP, United States legal counsel to the initial purchasers.

## **INDEPENDENT AUDITORS**

The consolidated financial statements of YPF Energía Eléctrica S.A. and its controlled companies as of December 31, 2018 and 2017 and January 1, 2017 and for the years ended December 31, 2018 and 2017 included in this offering memorandum have been audited by Deloitte & Co. S.A., independent auditors, as stated in their reports appearing herein.

## LISTING AND GENERAL INFORMATION

1. We have applied for the Notes to list on the Luxembourg Stock Exchange and to trading on the Euro MTF market and on the MAE.

2. The CUSIP and ISIN numbers for the initial Notes are as follows:

	CUSIP Number	ISIN Number
Rule 144A Global Notes .....	98424M AA1	US98424MAA18
Regulation S Global Notes .....	P9897P AB0	USP9897PAB06

3. We have obtained all necessary consents, approvals and authorizations in connection with the issuance and performance of the Notes. Our board of directors approved this issuance of Notes at its meeting held on July 17, 2019.

4. Except as described in this offering memorandum, there are no pending actions, suits or proceeds against or affecting us or any of our properties, which, if determined adversely to us, would individually or in the aggregate have an adverse effect on our financial condition or would adversely affect our ability to perform our obligations under the Notes or which are otherwise material in the context of the issue of the Notes, and, to the best of our knowledge, no such actions, suits or proceedings are threatened.

5. Except as described in this offering memorandum, there has been no change (or any development or event involving a prospective change of which we are or might reasonably be expected to be aware) that is materially adverse to our financial condition.

6. The creation of our note program was authorized by resolutions of our shareholders' meeting dated March 16, 2018; and approved by the CNV by Resolution No. RESFC-2019-20192-APN-DIR#CNV, dated April 17, 2019. The Program was approved by our shareholders on March 16, 2018. The issuance of the Notes was approved at the meeting of our board of directors held on July 17, 2019 pursuant to the powers delegated to our board of directors at our shareholders' meeting held on March 16, 2018.

7. For so long as any Notes are outstanding and listed on the Luxembourg Stock Exchange for trading on the Euro MTF, copies of the following items in English will be available free of charge during normal business hours at the offices of the Luxembourg listing agent and our principal office, at the addresses listed on the last page of this offering memorandum:

- our bylaws (*estatutos*);
- the Indenture relating to the Notes;
- our Financial Statements included in this offering memorandum; and
- our future audited annual financial statements and unaudited interim financial statements.

8. We confirm that, having taken all reasonable care to ensure that such is the case:

- the information contained in this offering memorandum is true, to the best of our knowledge, and correct in all material respects and is not misleading; and
- to the best of our knowledge, we have not omitted other material facts, the omission of which would make this offering memorandum as a whole misleading; and we accept responsibility for the information we have provided in this offering memorandum.



## INDEX TO FINANCIAL STATEMENTS

### **Audited Consolidated Financial Statements as of December 31, 2018, December 31, 2017 and January 1, 2017 and for the years ended December 31, 2018 and 2017.**

	<b><u>Page</u></b>
Independent Auditors' Report .....	F-2
Consolidated Statements of Financial Position.....	F-8
Consolidated Statements of Comprehensive Income .....	F-9
Consolidated Statements of Changes in Shareholders' Equity .....	F-10
Consolidated Statements of Cash Flow .....	F-12
Notes to the Consolidated Financial Statements.....	F-13

### **Unaudited Condensed Interim Consolidated Financial Statements as of March 31, 2019 and December 31, 2018 and for the three-month periods ended March 31, 2019, and March 31, 2018.**

	<b><u>Page</u></b>
Condensed Interim Consolidated Statements of Financial Position .....	F-75
Condensed Interim Consolidated Statements of Comprehensive Income .....	F-76
Condensed Interim Consolidated Statements of Changes in Shareholders' Equity.....	F-77
Condensed Interim Consolidated Statements of Cash Flow .....	F-79
Notes to the Condensed Interim Consolidated Financial Statements .....	F-80

## Independent Auditors' Report

To the President and Board of Directors of  
**YPF ENERGÍA ELÉCTRICA SOCIEDAD ANONIMA**  
Av. Córdoba 111, 14th Floor  
Buenos Aires City  
Argentina

### 1. Identification of the consolidated financial statements subject to audit

We have audited the accompanying consolidated statement of financial position of YPF ENERGÍA ELÉCTRICA SOCIEDAD ANONIMA (hereinafter referred to as "YPF EE S.A." or the "Company") and its controlled companies as of December 31, 2018 and 2017 and as of January 1, 2017, and the related consolidated statements of comprehensive income, cash flows and changes in shareholders' equity for each of the two years in the period ended December 31, 2018, and a summary of significant accounting policies and other explanatory information included in their notes 1 to 27.

### 2. Company's Board of Directors responsibility for the consolidated financial statements

The Company's Board of Directors is responsible for the preparation and fair presentation of the accompanying consolidated financial statements in accordance with International Financial Reporting Standards ("IFRS") as issued by the International Accounting Standards Board ("IASB"). Moreover, the Board of Directors is responsible of the internal control system that deems necessary to enable the preparation of consolidated financial statements that are free from material misstatements.

### 3. Auditors' responsibility

Our responsibility is to express and opinion on the accompanying consolidated financial statements, based on our audit. We conducted our audit in accordance with the International Standards on Auditing ("ISA") issued by the International Auditing and Assurance Standards Board ("IAASB") of the International Federation of Accountants ("IFAC"), as adopted in Argentina by the Argentine Federation of Professional Councils in Economic Sciences ("FACPCE") through Technical Resolution No. 32 and the Circulars of Adoption 1, 2, 3 and 4 of the standards issued by the IAASB and the International Ethics Standards Board for Accountants ("IESBA") of the IFAC. Those standards require that we comply with ethical requirements and plan and perform the audit to obtain reasonable assurance about whether the financial statements are free from material misstatements.

An audit involves performing procedures, substantially on a test basis, to obtain audit evidence about the amounts and disclosures in the consolidated financial statements. The procedures selected depend on the auditor's professional judgment, including the assessment of the risks of material misstatement of the consolidated financial statements.

In making those risk assessments, the auditor considers internal control relevant to the Company's preparation and fair presentation of the consolidated financial statements, in order to design audit procedures that are appropriate in the circumstances, but not for

the purpose of expressing an opinion on the effectiveness of the Company's internal control. An audit also includes evaluating the appropriateness of accounting policies used and the reasonableness of accounting estimates made by the Company's Board of Directors and Management, as well as evaluating the overall presentation of the consolidated financial statements.

We believe that the audit evidence we have obtained is sufficient and appropriate to provide a basis for our audit opinion.

#### **4. Opinion**

In our opinion, the consolidated financial statements referred to in the section 1 of this report, presents fairly, in all material respects, the financial position of YPF Energía Eléctrica S.A. and its controlled companies as of December 31, 2018 and 2017 and as of January 1, 2017, and the results of their operations and their cash flows for each of the two years in the period ended December 31, 2018, in accordance with International Financial Reporting Standards as issued by the IASB.

#### **5. Emphasis of matter**

Without modifying our opinion, we would like to emphasize that as indicated in note 2.1 to the consolidated financial statements mentioned in the section 1 of this report, these consolidated financial statements constitute the first set prepared in conformity with IFRS, as issued by the IASB. The effects of the changes caused by the application of the new accounting standards are presented in note 2.5 to the accompanying consolidated financial statements.

Buenos Aires City, Argentina

March 25, 2019

Deloitte & Co. S.A.

**Ricardo Ruiz**  
Partner

Deloitte refers to one or more of Deloitte Touche Tohmatsu Limited, a UK private company limited by guarantee ("DTTL"), its network of member firms, and their related entities. DTTL and each of its member firms are legally separate and independent entities. DTTL (also referred to as "Deloitte Global") does not provide services to clients. Please see [www.deloitte.com/about](http://www.deloitte.com/about) for a more detailed description of DTTL and its member firms.

Deloitte Touche Tomatsu Limited is a private Company limited by guarantee incorporated in England & Wales under Company number 07271800, and its registered office is Hill House, 1 Little new Street, London, EC4a, 3TR, United Kingdom.



**YPF ENERGÍA ELÉCTRICA S.A.**

**CONSOLIDATED FINANCIAL STATEMENTS  
AS OF DECEMBER 31, 2018 AND COMPARATIVE INFORMATION**

YPF ENERGÍA ELÉCTRICA S.A.

INDEX

Note	Description	Page
	Glossary of terms	1
	Legal Information	2
	Consolidated statements of financial position	3
	Consolidated statements of comprehensive income	4
	Consolidated statements of changes in shareholders' equity	5
	Consolidated statements of cash flow	7
	Notes to the consolidated financial statements:	
1	General information and main activities	8
2	Basis of preparation of the consolidated financial statements	9
3	Acquisitions and dispositions	34
4	Financial risk management	35
5	Financial instruments by category	38
6	Quantitative and qualitative information on fair values	39
7	Property, plants and equipment	41
8	Investment in associates and joint ventures	42
9	Other receivables	44
10	Trade receivables	44
11	Cash and cash equivalents	44
12	Income tax	45
13	Loans	46
14	Accounts payable	50
15	Revenues	50
16	Expenses by nature	50
17	Net financial results	51
18	Discontinued operations - Ramos Consortium	51
19	Shareholders' equity	52
20	Earnings per share	52
21	Restriction on retained earnings	53
22	Assets and liabilities in currencies other than peso	53
23	Main contractual commitments and guarantees granted	54
24	Regulatory framework	56
25	Tax reform	60
26	Information on related parties	62
27	Subsequent events	65

GLOSSARY OF TERMS

Term	Definition
ADR	American Depositary Receipt
AESA	Related Party A-Evangelista S.A.
AFIP	Argentine Tax Authority
Associate	Company over which YPF EE has significant influence as provided for in IAS 28
BICE	Banco de Inversión y Comercio Exterior
CAE	Electricity Supply Agreements
CAMMESA	Compañía Administradora del Mercado Mayorista Eléctrico S.A.
CDS	Related Party Central Dock Sud S.A.
CGU	Cash-Generating Units
CNV	Argentine Securities Commission
COD	Respect to a Thermal Power Plant, the commercial operation dates.
CSJN	Argentine Supreme Court of Justice
ENARGAS	Argentine Gas Regulator
ENARSA	Energía Argentina S.A.
ENRE	Argentine Electricity Regulator
FACPECE	Argentine Federation of Professional Councils in Economic Sciences
FODER	Trust Fund for Development of Renewable Energy Sources
FONINVEMEM	Fund for Investments Required to Increase the Electric Power Supply
GE	General Electric Corporation, Inc., or any of its subsidiaries and/or affiliates
GE EFS	GE EFS Power Investments B.V., an affiliate of GE
Group	YPF EE and its subsidiaries
GW	Gigawatts
GWh	Gigawatts per hour
IAS	International Accounting Standard
IASB	International Accounting Standards Board
IDS	Joint Venture Inversora Dock Sud S.A.
IFRIC	International Financial Reporting Standards Committee
IFRS	International Financial Reporting Standard
IGJ	Argentine Superintendence of Corporations
IPIM	Internal Wholesale Price Index ( <i>Índice de Precios Internos al por Mayor</i> )
IVA	Value Added Tax
Joint Venture	Company jointly owned by YPF EE as provided for in IFRS 11
LGS	Argentine General Corporations Law No. 19,550 (T.O. 1984), as amended
Loma Campana I	Loma Campana I thermal power plant located in the district of Añelo, Province of Neuquén.
Loma Campana II	Loma Campana II thermal power plant located in the district of Añelo, Province of Neuquén.
MATER	Renewable Energy Term Market (" <i>Mercado a Término de Energía Renovable</i> ")
MINEM	Ministry of Energy and Mining
MMBtu	Million British thermal units
MPIT	Minimum Presumed Income Tax
MW	Megawatts
MWh	Megawatts per hour
NO	Negotiable Obligations
OPESSA	Related party and non controlling interest Operadora de Estaciones de Servicios S.A.
PAS	Professional accounting standards (Argentine)
PEN	National Executive Power (" <i>Poder Ejecutivo Nacional</i> ")
PPA	Capacity and/or power purchase agreements
SADI	Argentine electricity grid (" <i>Sistema Argentino de Interconexión</i> ").
SE	Secretariat of Energy
SEC	U.S. Securities and Exchange Commission
SEE	Secretariat of Energy Electric
SIC	Standing Interpretations Committee
Subsidiary	Company controlled by YPF EE in accordance with the provisions of IFRS 10.
US\$	U.S. dollar
US\$/Bbl	U.S. dollar per barrel
WEM	Argentine Wholesale Electricity Market
Y-GEN	Subsidiary Y-GEN Eléctrica S.A.U. (previously Y- GEN ELECTRICA S.R.L.) <sup>(1)</sup>
Y-GEN II	Subsidiary Y-GEN Eléctrica II S.A.U. (previously Y- GEN ELECTRICA II S.R.L.) <sup>(1)</sup>
Y-GEN III	Subsidiary Y-GEN Eléctrica III S.R.L.
Y-GEN IV	Subsidiary Y-GEN Eléctrica IV S.R.L.
YPF	YPF Sociedad Anónima
YPF EE	YPF Energía Eléctrica S.A. or the Company
YPF EE Comercializadora	Subsidiary YPF EE Comercializadora S.A.U.

(1) The transformation is pending registration before the General Inspection of Justice.

**LEGAL INFORMATION**

Legal address

Av. Córdoba 111, 14th Floor – Buenos Aires – Argentina

Fiscal year

N° 6 beginning on January 1, 2018

Principal business of the Company

Generation, transport and commercialization of electric power from all kind of primary sources of production, and exploration and exploitation of oil and natural gas in the Ramos Area, province of Salta (operations related to Ramos Consortium constitutes discontinued operations, see Note 3.a).

Tax identification code (“CUIT”): 30-71412830-9.

Registration date with the Public Commerce Registry:

- Of the articles of incorporation: August 26, 2013.
- Last amendment to bylaws: March 20, 2018

Registration with the IGJ: 16,440 of Book 65, Volume A of Corporations (“Sociedades Anónimas”).

Duration of the company: Through August 26, 2112.

Capital Stock

(Amounts expressed in Argentine Pesos - See Note 19)

<u>Class of shares</u>	<u>Subscribed, paid-in and issued</u>	<u>Subscribed, paid-in, issued and registered</u>	<u>Total</u>
Commons, book entry shares, with a nominal value of 1 each and entitled to one vote per share:			
Class A	303,747,096	2,506,555,895	2,810,302,991
Class B	936,767,364	-	936,767,364
	<u>1,240,514,460</u>	<u>2,506,555,895</u>	<u>3,747,070,355</u>

MARCOS MIGUEL BROWNE  
 President

**YPF ENERGÍA ELÉCTRICA SOCIEDAD ANÓNIMA**  
**CONSOLIDATED STATEMENTS OF FINANCIAL POSITION**  
**AS OF DECEMBER 31, 2018 , DECEMBER 31, 2017 AND JANUARY 1, 2017**  
 (Amounts expressed in thousands of Argentine Pesos)



	<u>Notes</u>	<u>12.31.2018</u>	<u>12.31.2017</u>	<u>01.01.2017</u>
<b>ASSETS</b>				
<b>Non-current assets</b>				
Property, plant and equipment	7	37,650,465	5,234,723	1,941,058
Intangible assets	3.d / 3.e	196,835	-	-
Investments in associates and joint ventures	8	1,948,492	2,424,677	459,326
Other receivables	9	1,846,127	623,638	802,708
Investment in financial assets	6	69,901	-	-
Deferred tax asset	12	54,153	-	-
<b>Total non-current assets</b>		<b><u>41,765,973</u></b>	<b><u>8,283,038</u></b>	<b><u>3,203,092</u></b>
<b>Current assets</b>				
Inventories		-	585	256
Other receivables	9	6,234,304	255,428	212,603
Trade receivables	10	3,724,234	707,855	372,205
Other financial assets	5	1,489,031	-	-
Cash and cash equivalents	11	4,701,336	139,082	651,447
<b>Total current assets</b>		<b><u>16,148,905</u></b>	<b><u>1,102,950</u></b>	<b><u>1,236,511</u></b>
<b>TOTAL ASSETS</b>		<b><u>57,914,878</u></b>	<b><u>9,385,988</u></b>	<b><u>4,439,603</u></b>
<b>SHAREHOLDERS' EQUITY</b>				
Shareholders' contributions		8,411,982	2,506,556	58,816
Reserves, other comprehensive income and retained earnings		17,109,294	1,406,831	1,688,589
<b>TOTAL SHAREHOLDERS' EQUITY</b>		<b><u>25,521,276</u></b>	<b><u>3,913,387</u></b>	<b><u>1,747,405</u></b>
<b>LIABILITIES</b>				
<b>Non-current liabilities</b>				
Provisions		35,421	91,261	63,447
Deferred income tax liability	12	2,430,623	347,288	157,886
Loans	13	18,256,570	3,088,604	1,679,560
Other liabilities		-	-	200
<b>Total non-current liabilities</b>		<b><u>20,722,614</u></b>	<b><u>3,527,153</u></b>	<b><u>1,901,093</u></b>
<b>Current liabilities</b>				
Provisions		-	14,594	12,219
Income tax payable		-	-	42,630
Taxes payable		340,436	11,839	65,002
Salaries and social security		151,256	47,012	22,881
Loans	13	6,514,408	992,375	8,985
Other liabilities		99,359	200	-
Accounts payable	14	4,565,529	879,428	639,388
<b>Total current liabilities</b>		<b><u>11,670,988</u></b>	<b><u>1,945,448</u></b>	<b><u>791,105</u></b>
<b>TOTAL LIABILITIES</b>		<b><u>32,393,602</u></b>	<b><u>5,472,601</u></b>	<b><u>2,692,198</u></b>
<b>TOTAL SHAREHOLDERS' EQUITY AND LIABILITIES</b>		<b><u>57,914,878</u></b>	<b><u>9,385,988</u></b>	<b><u>4,439,603</u></b>

Accompanying notes are an integral part of these consolidated financial statements.

MARCOS MIGUEL BROWNE  
 President



**YPF ENERGÍA ELÉCTRICA SOCIEDAD ANÓNIMA**  
**CONSOLIDATED STATEMENTS OF COMPREHENSIVE INCOME**  
**FOR THE FOR THE YEARS ENDED DECEMBER 31, 2018 AND 2017**



(Amounts expressed in thousands of Argentine Pesos)

	Notes	For the year ended December 31,	
		2018	2017
Revenues	15	7,124,905	1,470,670
Production costs	16	(2,401,625)	(443,646)
<b>Gross profit</b>		<b>4,723,280</b>	<b>1,027,024</b>
Administrative and selling expenses	16	(544,414)	(183,508)
Remeasurement of pre-existing equity interest	3.b	1,785,033	-
Other net operating results		(292)	(723)
<b>Operating profit</b>		<b>5,963,607</b>	<b>842,793</b>
Income from equity interest in associates		268,015	67,503
Net financial results	8		
- Financial income	17	1,285,441	208,769
- Financial loss	17	(2,607,963)	(197,190)
<b>Profit before income tax from continuing operations</b>		<b>4,909,100</b>	<b>921,875</b>
Income tax	12	(416,984)	(269,105)
<b>Net profit for the year from continuing operations</b>		<b>4,492,116</b>	<b>652,770</b>
Profit after income tax for the year from discontinued operations	18	13,296	193,987
<b>Net profit for the year</b>		<b>4,505,412</b>	<b>846,757</b>
<b>Other comprehensive income for the year</b>			
Other comprehensive income that will not be reclassified to net income in subsequent years	2.3.19	11,170,660	542,191
Other comprehensive income that will be reclassified to net income in subsequent years	2.3.19	26,391	-
<b>Net variation of other comprehensive income</b>		<b>11,197,051</b>	<b>542,191</b>
<b>Total comprehensive income for the year</b>		<b>15,702,463</b>	<b>1,388,948</b>
<b>Net income for the year attributable to shareholders</b>			
Continuing operations		4,492,116	652,770
Discontinued operations		13,296	193,987
<b>Total comprehensive income for the year attributable to shareholders</b>		<b>4,505,412</b>	<b>846,757</b>
Continuing operations		15,689,167	1,194,961
Discontinued operations		13,296	193,987
		<b>15,702,463</b>	<b>1,388,948</b>
Basic and diluted earnings per share from continuing and discontinued operations:			
- Basic and diluted (ARS)	20	1.275	0.559
Basic and diluted earnings per share from continuing operations			
- Basic and diluted (ARS)	20	1.271	0.431

Accompanying notes are an integral part of these consolidated financial statements.

MARCOS MIGUEL BROWNE  
 President

**YPF ENERGÍA ELÉCTRICA SOCIEDAD ANÓNIMA**  
**CONSOLIDATED STATEMENTS OF CHANGES IN SHAREHOLDERS' EQUITY**  
**FOR THE YEARS ENDED DECEMBER 31, 2018 AND 2017**  
(Amounts expressed in thousands of Argentine Pesos)



	For the year ended December 31, 2018							
	Shareholders' contributions		Reserves			Other comprehensive income	Retained earnings	Total
	Subscribed capital	Share Premium	Others shareholders' contributions	Legal reserve	Voluntary reserves			
<b>As of January 1, 2018</b>	2,506,556	-	-	6,351	-	542,191	858,289 (1)	3,913,387
As decided by the General Extraordinary Shareholders' Meeting of January 12, 2018 (Note 19):								
- Capital increase	303,747	-	-	-	-	-	-	303,747
As decided by the Ordinary and General Extraordinary Shareholders' Meeting of March 20, 2018 (Note 19):								
- Capital increase	936,767	-	-	-	-	-	-	936,767
- Contribution in share premium	-	4,604,483	-	-	-	-	-	4,604,483
Sale of Ramos Consortium and the interest in Central Dock Sud S.A. (Note 3.a))	-	-	60,429	-	-	-	-	60,429
As decided by the Shareholders' Meeting of April 26, 2018 (Note 19)								
- Legal Reserve	-	-	-	46,404	-	-	(46,404)	-
- Specifically prescribed voluntary reserves	-	-	-	-	881,681	-	(881,681)	-
Others comprehensive income for the year	-	-	-	-	-	11,197,051	-	11,197,051
Net profit for the year	-	-	-	-	-	-	4,505,412	4,505,412
<b>As of December 31, 2018</b>	<b>3,747,070</b>	<b>4,604,483</b>	<b>60,429</b>	<b>52,755</b>	<b>881,681</b>	<b>11,739,242</b>	<b>4,435,616</b>	<b>25,521,276</b>

(1) Includes 11,532 corresponding to the initial adjustment for the implementation of IFRS, that will be allocated to a special reserve in the next shareholders' meeting that approves the financial statement as of December 31, 2018. See Note 2.3.19.

Accompanying notes are an integral part of these consolidated financial statements.

MARCOS MIGUEL BROWNE  
President  
F-10

**YPF ENERGÍA ELÉCTRICA SOCIEDAD ANÓNIMA**  
**CONSOLIDATED STATEMENTS OF CHANGES IN SHAREHOLDERS' EQUITY**  
**FOR THE YEARS ENDED DECEMBER 31, 2018 AND 2017**  
(Amounts expressed in thousands of Argentine Pesos)



	For the year ended December 31, 2017								
	Shareholders' contributions			Reserves					
	Subscribed capital	Capital Adjustment	Share Premium	Legal reserve	Reserve for future dividends	Voluntary reserve	Other comprehensive income	Retained earnings	Total
<b>As of January 1, 2017</b>	30,006	1,746	27,064	6,351	60,456	1,029,530	-	592,252 (1)	1,747,405
As decided by the General Ordinary Shareholders' Meeting of May 26, 2017									
- Capital Adjustment capitalization	1,746	(1,746)	-	-	-	-	-	-	-
- Reserve for future dividends capitalization	60,456	-	-	-	(60,456)	-	-	-	-
- Share premium capitalization	27,064	-	(27,064)	-	-	-	-	-	-
- Voluntary Reserve capitalization	1,029,530	-	-	-	-	(1,029,530)	-	-	-
- Retained earnings capitalization	580,720	-	-	-	-	-	-	(580,720)	-
- YPF S.A. in kind capital increase	777,034	-	-	-	-	-	-	-	777,034
Other comprehensive income for the year	-	-	-	-	-	-	542,191	-	542,191
Net profit for the year	-	-	-	-	-	-	-	846,757	846,757
<b>As of December 31, 2017</b>	<b>2,506,556</b>	<b>-</b>	<b>-</b>	<b>6,351</b>	<b>-</b>	<b>-</b>	<b>542,191</b>	<b>858,289</b>	<b>3,913,387</b>

(1) Includes 11,532 corresponding to the initial adjustment for the implementation of IFRS, that will be allocated to a special reserve in the next shareholders' meeting that approves the financial statement as of December 31, 2018. See Note 2.3.19.

Accompanying notes are an integral part of these consolidated financial statements.

MARCOS MIGUEL BROWNE  
President

F-11

**YPF ENERGÍA ELÉCTRICA SOCIEDAD ANONIMA**  
**CONSOLIDATED STATEMENTS OF CASH FLOW**  
**FOR THE YEARS ENDED DECEMBER 31, 2018 AND 2017**  
(Amounts expressed in thousands of Argentine Pesos)



	<u>12.31.2018</u>	<u>12.31.2017</u>
<b>OPERATING ACTIVITIES</b>		
Net profit for the year from continuing operations	4,492,116	652,770
Net profit for the year from discontinued operations	13,296	193,987
Net profit for the year	<u>4,505,412</u>	<u>846,757</u>
Adjustments to reconcile net profit to net cash flows from operating activities:		
Income from equity interest in associates	(268,015)	(67,503)
Remeasurement of pre - existing equity interest	(1,785,033)	-
Depreciation of property, plant and equipment	1,283,274	88,815
Decreases of property, plant and equipment <sup>(3)</sup>	43,239	37,450
Collections of dividends	53,996	-
Net financial results	1,322,522	(11,579)
Movements in provisions <sup>(3)</sup>	35,421	10,383
Charge on income tax	419,065	365,979
Additional Indirect Remuneration and remuneration for non-recurring maintenance	-	(23,172)
Income tax payments	(44,255)	(103,878)
Changes in operating assets and liabilities:		
Trade receivables	(2,682,791)	(392,865)
Other receivables	(5,101)	146,030
Inventories <sup>(3)</sup>	-	(261)
Accounts payable <sup>(3)</sup>	2,262,156	58,772
Salaries and social security	104,244	22,632
Taxes payable	192,574	(170,935)
Interest paid to suppliers	-	(3,670)
Interest received from customers	-	98,213
<b>Net cash flows from operating activities</b>	<u><b>5,436,708</b></u>	<u><b>901,168</b></u>
<b>INVESTING ACTIVITIES</b>		
Acquisition of property, plant and equipment <sup>(1)</sup>	(7,838,730)	(2,171,036)
Acquisition of interest in subsidiaries <sup>(2)</sup>	(1,524,304)	-
Advances to suppliers to property, plant and equipment	(454,826)	(24,119)
Other financial assets	(1,290,497)	-
Sales of interests in subsidiaries	283,247	-
Contributions in joint ventures <sup>(4)</sup>	(4,076)	(809,314)
<b>Net cash flows used in investing activities</b>	<u><b>(10,829,186)</b></u>	<u><b>(3,004,469)</b></u>
<b>FINANCING ACTIVITIES</b>		
Proceeds for loans	9,877,729	2,065,429
Shareholders' contributions received	2,720,250	-
Payments of loans	(2,355,833)	(366,489)
Payment of interest and other financial costs	(949,923)	(176,737)
<b>Net cash flows from financing activities</b>	<u><b>9,292,223</b></u>	<u><b>1,522,203</b></u>
<b>Net increase (decrease) in cash and cash equivalents</b>	3,899,745	(581,098)
Effect of exchange difference variations on cash and cash equivalents	662,509	68,733
Cash and cash equivalents at the beginning of year (Note 11)	139,082	651,447
Cash and cash equivalents at the end of the year (Note 11)	<u><b>4,701,336</b></u>	<u><b>139,082</b></u>

- (1) Net of the variation of unpaid balances from additions to property, plant and equipment for the years ended December 31, 2018 and 2017 of 947,115 and 121,040 respectively, and of advanced to suppliers' transfers to property, plant and equipment of 574,559 and 167,625 as of December 31, 2018 and 2017, respectively. Additionally, net of not monetary transactions of 124,114 as of December 31, 2017 (See Note 13).
- (2) Net of cash and cash equivalents for 172,612 incorporated by business combination (Note 3.b)). Additionally, includes 48,496 and 22,266 for Luz del Cerro S.A. and Luz del Valle S.A. acquisitions, respectively (see Note 3.d)).
- (3) "Decreases of property, plant and equipment", "Movements in provisions", "Inventories" and "Accounts payable" for the year ended December 31, 2018 are shown net of the effect from the decreases of Ramos Consortium for amount an of (84,881), 105,855, (585) and 22,298 respectively (Note 3.a)).
- (4) Net of 18,830 of in kind contributions as of December 31, 2017.

Accompanying notes are an integral part of these consolidated financial statements.

MARCOS MIGUEL BROWNE  
President

**YPF ENERGÍA ELÉCTRICA SOCIEDAD ANÓNIMA**  
**NOTES TO THE CONSOLIDATED FINANCIAL STATEMENTS**  
**AS OF DECEMBER 31, 2018 AND COMPARATIVE INFORMATION**

(Amounts expressed in thousands of Argentine Pesos, except as otherwise indicated)

**1. GENERAL INFORMATION AND MAIN ACTIVITIES**

YPF Energía Eléctrica S.A. (hereinafter “the “Company”) is a Sociedad Anónima (Argentine business association type akin to a stock corporation) organized under the laws of Argentina. Its registered office is at Av. Córdoba N° 111, 14<sup>th</sup> Floor, Buenos Aires City.

YPF EE and the companies that make up the business Group are mainly engaged in (i) generating and selling electric power through three thermal generation plants located in the Province of Tucumán, two thermal generation plants and moto generators located in the Province of Neuquén, a cogeneration plant in the Province of Buenos Aires and a wind farm in the Province of Chubut (ii) building new thermal generation plants project in the Province of Tucumán and a cogeneration plant in La Plata; (iii) building wind farms in the Province of Santa Cruz and Buenos Aires; (iv) selling energy, (v) indirect participation through IDS in the generation and commercialization of electric energy through CDS thermal power plant; and (vi) exploring, exploiting, producing, transporting and/or storing liquid and gaseous hydrocarbons (discontinued operation, see Note 3.a)).

The Group has an installed capacity, at the date of issuance of these consolidated financial statements, of 1,819MW, 99MW of which begun operation during the second half of 2018, representing approximately 6.6% of the maximum power and approximately 8.5% of the average energy demanded in Argentina, according to information published by CAMMESA.

Additionally, the Group has projects under construction with an installed capacity of more than 634MW.

The Group's assets and generation projects portfolio are located in the provinces of Tucumán, Neuquén, Buenos Aires, Chubut and Santa Cruz.

**Thermal power stations**

The Company owns and operates the Tucumán Complex comprised of the Tucumán Thermal Power Plant, located in the town of El Bracho, approximately 22 km south of San Miguel de Tucumán, in the province of Tucumán, with a capacity of 447MW and the San Miguel de Tucumán Thermal Power Plant, with a capacity of 382MW. In addition, the Company expanded the Tucumán Complex through the thermal power plant of its subsidiary Y-GEN II, El Bracho TG. This power plant has a capacity of 267MW and obtained the Commercial Operation Date (COD) on January 27, 2018.

By virtue of Resolution No. 287-E/2017 from the Secretary of Electric Energy, Y-GEN II was awarded, as a consequence of the bidding process established, the project to close the existing open cycle power plant (El Bracho TG) into a combined cycle. Once the project is completed, the plant is expected to increase the total capacity in 198MW so that the total capacity of the plant will be approximately 465 MW, and the efficiency of 6,407 kJ / kWh (56.2%). In this way it would become the largest power station owned by the Group. The COD of the Thermal Power Plant is expected around second quarter of 2020.

In 2015, the Company developed the first thermal generation project called Loma Campana I, located in the town of Añelo, province of Neuquén, integrated by a thermal power plant of 105MW of installed capacity that obtained its COD at the beginning of November 2017 and, a through the figure of the distributed autogenerator. The Company provides capacity to YPF through an operation and maintenance agreement for a period of 15 years, with a fixed remuneration for availability with a price denominated in US dollars. Loma Campana I began to operate on November 7, 2017.

Loma Campana II, owned by Y-GEN, was built on the same site. It consists of a 107MW thermal power plant whose power and energy is committed under a PPA entered into with CAMMESA Campana II for a 10 year term from commercial operation and the price of which is denominated in US dollars. Loma Campana II started operating on November 30, 2017.

Additionally, the Company owns and operates the Loma Campana Este thermal power plant, located within the Loma Campana oil and gas production block concession, in the town of Añelo, province of Neuquén. This plant has a generation capacity of 17MW and provides energy for YPF's own consumption and it is not connected to the SADI.

During the year ended December 31, 2018, the Company acquired the asset La Plata Cogeneration, a thermal power plant previously owned by Central Puerto S.A., with a capacity of 128MW connected to SADI (see note 3.c)).

Finally, pursuant to Resolution No. 287 – E/2017, the Company was awarded a new cogeneration project to be developed within the La Plata Refinery, which is owned by YPF. This project consists in the installation of a gas turbine, its electric generator and a boiler to generate steam for heat recovery. The gas turbine will have a generating capacity of 85MW, and the steam generator of heat recovery (HRSG) generates 200 Tn / h with additional fire and 140 Tn / h without additional fire. The Company has signed a PPA contract with CAMMESA for a term of 15 years after being awarded in the bidding process mentioned. In the same bidding process it committed to install and maintain available a generation capacity of 72MW for the term of the contract from agreed date of the COD.

**YPF ENERGÍA ELÉCTRICA SOCIEDAD ANÓNIMA**  
**NOTES TO THE CONSOLIDATED FINANCIAL STATEMENTS**  
**AS OF DECEMBER 31, 2018 AND COMPARATIVE INFORMATION**

(Amounts expressed in thousands of Argentine Pesos, except as otherwise indicated)

**Renewable sources**

The Company owns the Parque Eólico Manantiales Behr, with 99MW of installed capacity, through 30 Vestas wind turbines of 3.3 MW of installed power each. On July 25, 2018 the first stage of the wind farm for the first 49.5 MW obtained the commercial operation permit and on December 22, 2018, the last commercial operation permit for the remaining 49.5 MW was obtained.

100% of the energy generated by this project is already operational and 50% is being delivered to YPF through a PPA for a term of 15 years with a price denominated in US dollars. The remaining energy generated will be sold to private. It should be noted that this project has dispatch priority in the MATER for 100% of its installed capacity.

The Group was awarded a PPA as part of the RenovAr 2.0 Program, for the provision of renewable energy through the Cañadón León Wind Power Project of 99MW of capacity. It is located in the province of Santa Cruz, 25 km from the city of Caleta Olivia, and approximately 100 km from "Parque Eólico Manantiales Behr". The PPA with CAMMESA, is for a term of 20 years, and a price denominated in US dollars.

Additionally, through the company Luz del Cerro S.A., acquired in May 2018, the Company is the owner of the "Los Teros" wind generation project of up to 122.5MW, located in the town of Azul, province of Buenos Aires. This project has priority dispatch in MATER transportation capacity for its whole installed capacity. The Company is currently in the process of signing the PPAs with various industries for their supply from such Wind Farm (see Note 3.d)).

On November 21, 2018, the Company acquired 100% of the shares of Luz del Valle S.A., a company whose single asset is the development of the wind farm project known as "Parque Eólico Los Teros II" (Los Teros II Wind Farm) located in the town of Azul, Province of Buenos Aires. The wind farm will have 49.8 MW of capacity (see Note 3.e))

**Shareholders of the Company**

Until the year ended December 31, 2017, the Company was controlled by YPF. On March 20, 2018 GE EFS Power Investments B.V. ("GE") a subsidiary of EFS Global Energy B.V. (both companies are indirectly controlled by GE Energy Financial Services, Inc.), subscribed shares of YPF EE equivalent to 24.99% of its capital stock, committing to contribute US\$ 275,000,000. Since GE's shares subscription by means of a Shareholders agreement, GE and YPF jointly control YPF EE (Note 19).

**2. BASIS OF PREPARATION OF THE CONSOLIDATED FINANCIAL STATEMENTS**

**2.1. Professional accounting standards**

The Company prepares its consolidated financial statements in accordance with IFRS, as issued by the IASB.

These consolidated financial statements for the year ended as of December 31, 2018, belong to the first year in which the Company will prepare its consolidated financial statements under IFRS.

For this purpose, the Company determined the effects of the changes in the professional accounting standards (PAS) applied until the previous year ended December 31, 2017. These effects were recognized retrospectively in accordance with IFRS 1 (First-time Adoption of International Financial Reporting Standards) by amending the measurement and presentation of the assets and liabilities as of January 1, 2017 (date of transition to IFRS), as well as the measurement and presentation of the assets and liabilities as of December 31, 2017, and comprehensive income for the year then ended. However, IFRS 1 requires that the recognized amounts not be amended retrospectively in some cases, and allows to opt for such treatment as an alternative criterion in other cases expressly indicated. The effects of these changes are disclosed in these consolidated financial statements.

Thus, the Company prepared and included in these consolidated financial statements: (i) the opening statement of financial position as of January 1, 2017 (date of transition to IFRS), prepared under IFRS, and (ii) the reconciliations between equity prepared under PAS and IFRS as of the date of transition to IFRS, and for the year ended December 31, 2017, respectively, and; (iii) the reconciliations between net profit under PAS and IFRS comprehensive income as of December 31, 2017, which are included in section 2.5 of this note.

The amounts and information for fiscal year ended December 31, 2017 and January 1, 2017 (the latter being the date of transition to the IFRS) are an integral part of the aforementioned financial statements and should only be read in connection with these financial statements.

Likewise, additional disclosures required by Argentine General Business Associations Law No. 19,550 and/or CNV regulations have been included with the only purposes of complying with such regulatory requirements.

**YPF ENERGÍA ELÉCTRICA SOCIEDAD ANÓNIMA**  
**NOTES TO THE CONSOLIDATED FINANCIAL STATEMENTS**  
**AS OF DECEMBER 31, 2018 AND COMPARATIVE INFORMATION**

(Amounts expressed in thousands of Argentine Pesos, except as otherwise indicated)

The issuance of the consolidated financial statements for the year ended on December 31, 2018 was approved by the Board of Directors on March 25, 2019.

**2.2. Basis of presentation and consolidation**

These financial statements were prepared under the assumption that the Company has the ability to continue as a going concern.

**2.2.1. Consolidated financial statements**

The consolidated financial statements include the financial statements of the Group made up by the parent company YPF EE and its subsidiaries Y-GEN, Y-GEN II, Luz del Cerro S.A., Luz del Valle S.A., Luz de Leon S.A, Y-Luz Inversora S.A.U., YPF EE Comercializadora and its associates Y-GEN III, Y-GEN IV and IDS.

These consolidated financial statements have been prepared by applying the consolidation method to all the subsidiaries that are the companies over which the Group holds control. The Group controls an entity when it is exposed, or it is entitled to the variable results arising from its equity interest in the entity, and has the ability to affect those results through its power over the entity. This capacity is, in general but not exclusively, obtained by the ownership, direct or indirect, of more than 50% of the voting shares of a company.

Subsidiaries are consolidated by including all their assets, liabilities, income, expenses and cash flows into the consolidated financial statements once the adjustments and eliminations corresponding to intra-Group transactions have been made.

The statements of comprehensive income of the subsidiaries are included in the consolidated statement of comprehensive income from the date on which the Company obtains control of the subsidiary until the date on which it loses control over the subsidiary.

The interest held in the Ramos Consortium that provided the Company with contractual interest rights on the assets and liabilities were consolidated as of January 1, and December 31, 2017, using the proportional consolidation method, based on the interest held in the consortium's assets and liabilities. Due to the sale of this interest described in Note 3.a), revenues and expenses are presented as discontinued operations in the consolidated statements of comprehensive income as of December 31, 2018 and 2017.

Each subsidiary's last financial statements available as of each year-end were used for consolidation purposes, considering the subsequent events, management information available and the transactions conducted between the Company and the subsidiaries that would have changed the subsidiaries' equity. Moreover, the accounting principles and criteria adopted by the subsidiaries were adapted, if needed, with those used in the preparation of the financial statements of the Company with the purpose of presenting the consolidated financial statements applying identical valuation and presentation methods.

The Group holds a 100% interest in the consolidated companies' capital stock. Therefore, there are no non-controlling interests.

**2.2.2. Measurement unit**

These consolidated financial statements have been prepared under the historical cost approach, with the exception of certain assets measured at fair value, with changes through the statement of comprehensive income.

**2.3. Summary of significant accounting policies**

The following are the significant accounting policies applied by the Group in preparing its consolidated financial statements.

**2.3.1. Functional and presentation currency**

Under IFRS the companies must define their functional currency, which may differ from the presentation currency. The functional currency must be defined according to the criteria set forth in IAS 21: "The effects of changes in foreign exchange rates". Based on the provisions of the referenced rule, and considering the main activities of the Company, its subsidiaries and associates, as detailed in Note 8, and the currency of the primary economic environment in which the entities operate, the Management and the Board of Directors have defined for the Group, the U.S. dollar as their functional currency. Therefore, the financial statements of the Group have been converted into dollars according to the procedure stated in IAS 21. According to such procedures, monetary assets and liabilities are converted at the closing exchange rate. Non-monetary items, measured in terms of the historical cost approach, as well as results, are converted using the exchange rate of the transaction date. The results of the conversion of monetary assets and liabilities denominated in currencies other than dollars are recognized in the result of the year in which they arise.

**YPF ENERGÍA ELÉCTRICA SOCIEDAD ANÓNIMA**  
**NOTES TO THE CONSOLIDATED FINANCIAL STATEMENTS**  
**AS OF DECEMBER 31, 2018 AND COMPARATIVE INFORMATION**

(Amounts expressed in thousands of Argentine Pesos, except as otherwise indicated)

In addition, under the provisions of CNV General Resolution No. 562, the Company is required to present its financial statements in Argentine pesos, and therefore, the amounts resulting from the aforementioned process are to be converted into pesos, according to the criteria specified in IAS 21. Under IAS 21, assets and liabilities should be converted at the applicable closing exchange rate, and results at the exchange rate of the date of each transaction (or, for convenience purposes, and when exchange rates do not vary significantly, at the average exchange rate of each month) and the resulting exchange differences should be recognized in Other Comprehensive Income.

Results reported in Other Comprehensive Income related to the conversion of the financial statements of the Company into its presentation currency (pesos), have no effect on the income tax or the deferred tax, since, at the time of they were generated, such transactions had no impact in the accounting and taxable income.

Assets and liabilities in functional currency have been converted into the presentation currency using the following exchange rates, respectively.

	<b>12.31.2018</b>	<b>12.31.2017</b>	<b>01.01.2017</b>
Argentine Peso (ARS)	37.60	18.60	15.84

### **2.3.2. Foreign Currency**

In preparing the consolidated financial statements, transactions in currencies other than the functional currency (foreign currencies) are booked at the exchange rates prevailing at the date of each transaction. At the closing date of each year, monetary items denominated in foreign currency are converted at exchange rates for the functional currency prevailing on the closing dates of the financial statements. Exchange differences are recognized in the income statement of the year in which they originated.

### **2.3.3. Classification of items as current and non-current**

The Group classifies assets and liabilities in the consolidated statement of financial position as current and non-current. An entity shall classify an asset as current when:

- it expects to realize the asset, or intends to sell or consume it, in its normal operating cycle;
- it holds the asset primarily for the purpose of trading;
- it expects to realize the asset within twelve months after the reporting period; or
- the asset is cash or a cash equivalent unless the asset is restricted from being exchanged or used to settle a liability for at least twelve months after the reporting period.

All other assets are classified as non-current.

An entity shall classify a liability as current when:

- it is expected to be settled in the normal operating cycle;
- it is held primarily for the purpose of trading;
- it is due to be settled within twelve months after the reporting period; or
- there is no unconditional right to defer the settlement of the liability for at least twelve months after the reporting period.

All other liabilities are classified as non-current.

Deferred tax assets and liabilities are classified as non-current assets and liabilities, in all cases.

### **2.3.4. Fair value measurement**

The Group measures certain financial instruments at their fair value at each reporting date. Fair values of financial instruments measured at amortized cost are disclosed in Note 6.

Fair value is the price that would be received to sell an asset or paid to transfer a liability in a transaction between market participants at the measurement date. The fair value measurement is based on the presumption that the transaction to sell the asset or transfer the liability takes place either:



**YPF ENERGÍA ELÉCTRICA SOCIEDAD ANÓNIMA**  
**NOTES TO THE CONSOLIDATED FINANCIAL STATEMENTS**  
**AS OF DECEMBER 31, 2018 AND COMPARATIVE INFORMATION**

(Amounts expressed in thousands of Argentine Pesos, except as otherwise indicated)

- In the principal market for the asset or liability, or
- In the absence of a principal market, in the most advantageous market for the asset or liability.

The principal or the most advantageous market must be accessible to the Group. The fair value of an asset or a liability is measured using the assumptions that market participants would use when pricing the asset or liability, assuming that market participants act in their economic best interest.

A fair value measurement of a non-financial asset takes into account a market participant's ability to generate economic benefits by using the asset in its highest and best use or by selling it to another market participant that would use the asset in its highest and best use.

The Group uses valuation techniques that are appropriate in the circumstances and for which sufficient data are available to measure fair value, maximizing the use of relevant observable inputs and minimizing the use of unobservable inputs.

All assets and liabilities for which fair value is measured or disclosed in the consolidated financial statements are categorized within the fair value hierarchy, described as follows, based on the lowest level input that is significant to the fair value measurement as a whole:

- Level 1 input data: quoted (unadjusted) prices in active markets for identical assets or liabilities.
- Level 2 input data: valuation techniques with input data other than quoted prices included in Level 1, but that are observable for the asset or liability, either directly or indirectly.
- Level 3 input data: valuation techniques for which input data are not observable for the asset or liability.

### **2.3.5. Revenue recognition**

#### **2.3.5.1. Revenues**

IFRS 15 presents a detailed five-step model to explain revenue from contracts with customers. Its main principle is that an entity must recognize revenue to represent the transfer of goods or services promised to customers, in an amount that reflects the consideration that the entity expects to receive in exchange for those goods or services, at the time of satisfying a performance obligation.

An asset is transferred when (or as) the client obtains control of that asset, defined as the ability to direct the use and obtain substantially all the remaining benefits of the asset. IFRS 15 requires analyzing:

- If the contract (or the combination of contracts) contains more than one promised good or service, when and how the goods or services should be granted.
- If the transaction price distributed to each performance obligation should be recognized as revenue over time or at a specific time. Under IFRS 15, an entity recognizes revenue when the obligation is satisfied, that is, when control of the goods and services that have a particular obligation is transferred to the customer. The new model does not include separate guidelines for the "sale of goods" and the "provision of services". Instead, it requires entities to assess whether revenue should be recognized over time or at a specific time, regardless of whether the income includes "sale of goods" or "provision of services".
- When the transaction price includes an item for estimating variable payments, how will the amount and time for revenue recognition affect. The concept of variable payment estimation is broad. A transaction price is considered variable due to discounts, reimbursements, credits, price concessions, incentives, performance bonuses, penalties and contingency agreements. The new model introduces a great condition for a variable consideration to be recognized as revenue: only until it is very unlikely that a significant change in the amount of accumulated income will occur and when the uncertainties inherent in the variable payment estimate have been resolved.
- When the costs incurred to finalize a contract and the costs to fulfill it can be recognized as an asset.

The Company recognizes revenue based on the availability of effective capacity of its plants, of the energy delivered and of the steam delivered, and an account receivable is also recognized. This receivable represents the unconditional right of the Company to receive the consideration owed by the customer. The billing of the service is performed on a monthly basis and the consideration is usually received in less than 90 days (except in the case of additional remuneration and non-recurring maintenance). The opportunity to satisfy the performance obligation occurs over time because the client receives and simultaneously consumes the benefits provided by the performance of the obligation by the entity.

**YPF ENERGÍA ELÉCTRICA SOCIEDAD ANÓNIMA**  
**NOTES TO THE CONSOLIDATED FINANCIAL STATEMENTS**  
**AS OF DECEMBER 31, 2018 AND COMPARATIVE INFORMATION**

(Amounts expressed in thousands of Argentine Pesos, except as otherwise indicated)

Revenue from the sale of energy and steam and power made available capacity and steam (including additional remuneration and non-recurring maintenance receivables) is calculated at the prices set in the relevant agreements or at the prices prevailing in the electricity market, pursuant to current regulations. It includes revenue from energy, steam and capacity made available and/or delivered and not billed until the end of the year, valued at the prices set in agreements or in the relevant regulations.

Revenues from sales of crude oil and natural gas are recognized at the time property and risks are transferred to the customer, depending on the prices of current contracts with customers or based on the best estimate of the price to be obtained for these deliveries (discontinued activities, see Note 3.a)).

Additionally, the requirements requested to provide information disclosures are included in Note 15.

**2.3.5.2. Net financial results**

For all financial assets and liabilities measured at amortized cost and at fair value through profit and loss, interest income or expense is recorded using the effective interest rate method, which is the rate that exactly discounts the estimated future cash payments or receipts through the expected life of the financial instrument or a shorter period, as appropriate, with respect to the net carrying amount of the financial asset or liability. Interest income and expense is included in "net financial results" in the consolidated statement of comprehensive income.

**2.3.6. Taxes**

**2.3.6.1. Current income tax and minimum presumed income tax**

Current income tax assets and liabilities are measured at the amount expected to be recovered from or paid to the tax authorities. The tax rates and tax laws used to calculate those amounts are those that are enacted or substantively enacted at the end of the year. The statutory tax rate for the Group for the fiscal year 2018 is 30% (see Note 25).

Current income tax relating to items recognized directly in equity is recognized in equity and not in the consolidated statement of comprehensive income.

Management periodically evaluates positions taken in the tax returns with respect to situations in which applicable tax regulations are subject to interpretation and recognizes provisions where appropriate.

Minimum presumed income tax is supplementary to the income tax since while the latter is calculated on taxable income as of the end of each year, minimum presumed income tax is a minimum levy determined by applying the current 1% rate to the potential income of certain productive assets. Therefore, the Company's tax obligation shall be the higher of these two taxes. However, should minimum presumed income tax exceed current income tax in a given tax year, such excess may be carried forward as an advanced payment of any income tax in excess of the minimum presumed income tax that could occur in any of the ten subsequent fiscal years.

Minimum presumed income tax credit is measured at non-discounted nominal value, as it is similar to a deferred income tax asset.

On May 18, 2017, the AFIP (Argentine Tax Authority) issued General Instruction No. 2/2017 whereby the criteria laid down in the rulings of the Argentine Supreme Court of Justice in the cases "Hermitage S.A." and "Diario Perfil" is adopted. Based on these rulings, where losses in the financial statements for a given period can be proved, and the income tax return records tax loss carry-forwards for that same period, this is enough to demonstrate that the minimum income presumed by the law has not existed, and therefore, the payment of the minimum presumed income tax does not apply.

The carrying amount of minimum presumed income tax is reviewed as of the end of each year and an impairment provision is recorded in the statement of comprehensive income under income tax charge to the extent that its use as an advance payment of income tax in future fiscal years is no longer probable. Minimum presumed income tax credit not recognized or previously derecognized is reviewed as of the end of each year, and it is recognized as an asset and a gain in the statement of comprehensive income for the year under income tax expense to the extent that it is likely to be used as an advance payment of income tax payable in future years.

On July 22, 2016, Law No. 27,260 was published, which, among other aspects, repealed the minimum presumed income tax for fiscal years beginning on or after January 1, 2019.

**2.3.6.2. Deferred income tax**

Deferred income tax is provided for using the liability method on temporary differences at the end of the year between the tax basis of assets and liabilities and their related carrying amounts.

**YPF ENERGÍA ELÉCTRICA SOCIEDAD ANÓNIMA**  
**NOTES TO THE CONSOLIDATED FINANCIAL STATEMENTS**  
**AS OF DECEMBER 31, 2018 AND COMPARATIVE INFORMATION**

(Amounts expressed in thousands of Argentine Pesos, except as otherwise indicated)

Deferred income tax liabilities are recognized for all taxable temporary differences, except:

- when the deferred income tax liability arises from the initial recognition of goodwill or of an asset or liability in a transaction that is not a business combination and, at the time of the transaction, affects neither the accounting profit nor taxable profit or loss and;
- in respect of taxable temporary differences associated with investments in subsidiaries and associates, where the timing of the reversal of the temporary differences can be controlled and it is probable that the temporary differences will not reverse in the foreseeable future.

Deferred income tax assets are recognized for all deductible temporary differences and tax loss carry forwards losses, to the extent that it is probable that taxable profit will be available against which the deductible temporary differences, and/or the tax losses carry forward can be utilized, except:

- where the deferred income tax asset arises from the initial recognition of an asset or liability in a transaction that is not a business combination and, at the time of the transaction, affects neither the accounting profit nor taxable profit or loss and;
- in respect of deductible temporary differences associated with investments in subsidiaries, associates and interests in joint ventures, deferred income tax assets are recognized only to the extent that it is probable that the deductible temporary differences will reverse in the foreseeable future and taxable profit will be available against which those differences can be utilized.

The carrying amount of deferred income tax assets is reviewed as of the end of each year and reduced through the comprehensive income or other comprehensive income, to the extent that it is no longer probable that sufficient taxable profit will be available to allow all or part of the deferred income tax asset to be utilized (recovered). Unrecognized deferred income tax assets are reassessed as of the end of each year and are recognized through the income statement or other comprehensive income for the year, as the case may be, to the extent that it has become probable that future taxable profits will allow the deferred income tax asset not previously recognized to be recovered.

Deferred income tax assets and liabilities are measured at undiscounted nominal value at the tax rates that are expected to apply in the year when the asset is realized or the liability is settled, based on tax rates and tax laws that have been enacted or substantively enacted at the end of the year (see Note 25).

Deferred income tax items are recognized in correlation to the underlying transactions either in the statement of other comprehensive income or directly in equity.

Deferred income tax assets and deferred income tax liabilities are offset if a legally enforceable right exists to set off current income tax assets and liabilities and the deferred income taxes relate to the same taxable entity and the same taxation authority.

**2.3.6.3. Other taxes related to sales and to bank account transactions**

Revenues from recurring activities, expenses incurred and assets are recognized excluding the amount of any sales tax, as in the case of value-added tax or turnover tax, or the tax on bank account transactions, except:

- where the tax incurred on a sale or on a purchase of assets or services is not recoverable from the taxation authority, in which case the sales tax is recognized as part of the cost of acquisition of the asset or as part of the expense item as the case may be and;
- trade receivables and payables are stated including value-added tax.

Turnover taxes and the tax on bank account transactions charge is included in Administrative and selling expenses within the consolidated statement of comprehensive income.

The net amount of the tax related to sales and to bank account transactions recoverable from, or payable to, the tax authority is included as a non-financial asset or liability, as the case may be.

**YPF ENERGÍA ELÉCTRICA SOCIEDAD ANÓNIMA**  
**NOTES TO THE CONSOLIDATED FINANCIAL STATEMENTS**  
**AS OF DECEMBER 31, 2018 AND COMPARATIVE INFORMATION**

(Amounts expressed in thousands of Argentine Pesos, except as otherwise indicated)

**2.3.7. Property, plant and equipment**

**2.3.7.1. Generation and selling of electric energy**

Property, plant and equipment is carried at cost, net of accumulated depreciation and/or accumulated impairment losses, if any. Cost includes all expenses directly attributable to bringing the asset to the location and condition necessary for it to be capable of operating.

Borrowing costs from third parties directly attributable to the acquisition, construction or production of an asset that necessarily takes a substantial period of time to get ready for its intended use are capitalized as part of the cost of the asset.

When major maintenance is performed that recovers the capacity of the asset, its cost is capitalized if the conditions for the recognition thereof as an asset are met and are depreciated separately based on their specific useful life.

The costs of renewals, improvements and enhancements that extend the useful life of properties and/or improve their service capacity are capitalized. As property, plant and equipment are retired, the related cost and accumulated depreciation are derecognized.

All other regular repair and maintenance costs are recognized in the consolidated statement of comprehensive income as incurred.

Property, plant and equipment, net of its recoverable residual value are depreciated composing such item by distributing linearly the cost of the different elements that compose it between the years of estimated useful life of each asset as follows:

	<u>Useful life in years</u>
Buildings	50
Production facilities, machinery, equipment of power plants	15-25
Transportation equipment	5
Furniture, fixtures and computer and communication equipment	3

The residual values, useful lives and methods of depreciation are reviewed as of the end of each year and adjusted prospectively, if appropriate.

An item of property, plant and equipment is derecognized upon disposal or when no future economic benefits are expected to arise from the continued use of the asset. Any gain or loss arising on the disposal or retirement of an item of property, plant and equipment is determined as the difference between the sales proceeds and the carrying amount of the asset and is recognized in profit or loss.

**2.3.7.2. Oil and gas production**

The Company used the successful effort method to account for transactions related to oil and gas exploration and production activities. Therefore, exploration costs, excluding costs from exploration wells, have been charged to the statement of comprehensive income when incurred. Drilling costs for exploration wells, including stratigraphic test wells, are capitalized until it is determined if there are proven reserves to justify their commercial development. If such reserves are not found, those drilling costs are charged to the statement of comprehensive income. Occasionally, upon completion of the exploration well drilling, the existence of reserves that cannot yet be classified as proven reserves may be determined. In those cases, if a volume of reserves justifying its development as a production well has been discovered, and if the Company is achieving substantial progress in the assessment of reserves and the economic and operating viability of the project, the cost of the exploration well is maintained as an asset. If any of those conditions is not met, the related costs are charged to the statement of comprehensive income.

Drilling costs applicable to production wells and to development dry wells and the costs of equipment related to the development of oil and gas reserves have been capitalized.

Costs capitalized related to production activities have been depreciated using the production units method, through application of the relation between the oil and gas produced and the proven and developed oil and gas reserves that are estimated to be recovered.

Costs capitalized related to acquisition of properties and extension of concessions with proven reserves, have been depreciated using the production units method, through application of the relation between the oil and gas produced and the total proven and developed oil and gas reserves.

**YPF ENERGÍA ELÉCTRICA SOCIEDAD ANÓNIMA**  
**NOTES TO THE CONSOLIDATED FINANCIAL STATEMENTS**  
**AS OF DECEMBER 31, 2018 AND COMPARATIVE INFORMATION**

(Amounts expressed in thousands of Argentine Pesos, except as otherwise indicated)

Depreciation is reviewed as a consequence of changes in estimates of the proven reserves of crude oil and gas after the date when such changes are disclosed. The Company reviews reserves estimates at least once a year.

Costs for obligations for the abandonment of hydrocarbon wells are recorded at the present value, together with the assets that originated them and are depreciated using the production units method. A liability is also recognized for that concept at the present value of the amounts to be paid. Changes in estimates of the discounted amounts to be paid are carried out taking into consideration current costs incurred for the abandonment of wells or other external information available, if the obligations for the abandonment of wells were not carried out. Those costs are the best estimate of the liability for the abandonment of wells.

During the year ended December 31, 2018 the Company discontinued this activity (see Note 3.a)).

**2.3.8. Impairment of property, plant and equipment**

The Group assesses as of the end of each period or year whether there is an indication that an individual component or a group of property, plant and equipment may be impaired. If any indication exists, the Group estimates the asset's recoverable amount. An asset's recoverable amount is the higher of the fair value less costs to sell that asset, and its value-in-use. That amount is determined for an individual asset, unless the asset does not generate cash inflows that are largely independent of those from other assets or groups of assets, in which case, the cash flows of the group of assets that form part of the cash-generating unit ("CGU") to which they belong are taken. To this end, the Group defined each generation plant as an independent CGU.

When the carrying amount of an individual asset or CGU exceeds its recoverable amount, the individual asset or CGU, as the case may be, is considered impaired and is written down to its recoverable amount.

In assessing value in use of an individual asset or CGU, the estimated future cash flows are discounted to their present value using a discount rate that reflects the weighted average capital cost employed for the Group.

In determining fair value less costs to sell, recent market transactions are taken into account, if available. If no such transactions can be identified, an appropriate valuation model is used. These calculations are verified by valuation multiples, quoted values for similar assets on active markets and other available fair value indicators, if any.

The Group bases its impairment calculation on detailed budgets and forecast calculations which are prepared separately for each of the Group's CGU to which the individual assets are allocated. These detailed budgets and forecast calculations generally cover the useful life of the asset.

Impairment losses of continuing operations are recognized in the consolidated statement of comprehensive income.

In addition, for the assets for which an impairment loss had been booked, as of the end of each period or year, an assessment is made whether there is any indication that previously recognized impairment losses may no longer exist or may have decreased.

If any indication exists, the Group estimates the individual asset's or CGU recoverable amount, as applicable.

A previously recognized impairment loss is reversed only if there has been a change in the assumptions used to determine the individual assets or CGU's recoverable amount since the last impairment loss was recognized. The reversal is limited so that the carrying amount of the asset or CGU does not exceed its recoverable amount, nor exceed the carrying amount that would have been determined, net of the related depreciation or amortization, had no impairment loss been recognized for the asset or CGU in prior periods. Such reversal is recognized in the statement of income in the same line in which the related impairment charge was previously recognized, unless the asset is carried at a revalued amount, in which case, the reversal is treated as a revaluation increase.

As of December 31, 2018, 2017 and January 1st, 2017, no impairment charge or reversal of impairment charges was recognized.

**2.3.9. Financial instruments**

A financial instrument is any contract that gives rise to a financial asset of one entity and a financial liability or equity instrument of another entity.

**YPF ENERGÍA ELÉCTRICA SOCIEDAD ANÓNIMA**  
**NOTES TO THE CONSOLIDATED FINANCIAL STATEMENTS**  
**AS OF DECEMBER 31, 2018 AND COMPARATIVE INFORMATION**

(Amounts expressed in thousands of Argentine Pesos, except as otherwise indicated)

**2.3.9.1. Financial assets**

**Classification**

In accordance with IFRS 9 “Financial instruments”, the Group classifies its financial assets into three categories:

– Financial assets at amortized cost

Financial assets are measured at amortized cost if both of the following criteria are met: (i) the objective of the Group’s business model is to hold the assets to collect the contractual cash flow, and (ii) the contractual terms only represent payment of principal and interest (SPPI criterion).

In addition, and for assets that meet the above conditions, IFRS 9 contemplates the option of designating, at the time of the initial recognition, an asset as measured at its fair value, if doing so would eliminate or significantly reduce the valuation or recognition inconsistency that could arise in the event that the valuation of the assets and liabilities or the recognition of profit or losses would be done on a different basis. The Group has not designated a financial asset at fair value by using this option.

As of the closing date of these consolidated financial statements, the Group’s financial assets at amortized cost include certain elements of cash and cash equivalents, trade receivables, other receivables and other financial assets (Y-GEN and Y-GEN II reserve account, in connection with the Citibank N.A. loan taken – See Note 13).

– Financial assets at fair value with changes through other comprehensive income

The financial assets are measured at fair value with changes through other comprehensive income if the financial assets are held in a business model whose objective is achieved by obtaining contractual cash flows and selling financial assets.

As of the closing date of these consolidated financial statements, the Group’s financial assets at fair value with changes in other comprehensive incomes include derivatives financial instruments, which are included in the “Investment on financial assets” line item.

– Financial assets at fair value through profit or loss

The financial assets at fair value through profit or loss correspond to a residual category that includes financial instruments that are not held under one of the two business models indicated above, including those held for trading and those designated at fair value.

As of December 31, 2017, and during the fiscal year ended at December 31, 2018, the Group’s financial assets at fair value through profit or loss include mutual funds, which are included in the “Cash and cash equivalents” line item.

**Recognition and measurement**

Purchases and sales of financial assets are recognized on the date the Group commits to purchase or sell the assets.

Financial assets at amortized cost are initially recognized at fair value plus transaction costs. These assets accrue interest based on the effective interest rate method.

Financial assets at fair value through profit or loss and through other comprehensive income are initially recognized at fair value and transaction costs are recognized as an expense in the statement of comprehensive income. They are subsequently valued at fair value. Changes in fair values and results from sales of financial assets at fair value through profit or loss are recorded in “Net financial results” in the statement of comprehensive income. Changes in fair of financial assets through other comprehensive income value are recorded in other comprehensive income.

In general, the Group uses the transaction price to ascertain the fair value of a financial instrument on initial recognition. In other cases, the Group records a gain or loss on initial recognition only if the fair value of the financial instrument can be supported by other comparable and observable market transactions for the same type of instrument or if it is based in a technical valuation that only inputs observable market information. Unrecognized gains or losses on initial recognition of a financial asset are recognized later, only to the extent they arise from a change in the factors (including time) that market participants would consider upon setting the price.

Gains/losses on debt instruments measured at amortized cost and not designated in a hedging relationship are charged to income when the financial assets are derecognized or an impairment loss is recognized and during the amortization process using the effective interest rate method. The Group reclassifies investments on debt instruments only when its business model for managing those assets changes.

**YPF ENERGÍA ELÉCTRICA SOCIEDAD ANÓNIMA**  
**NOTES TO THE CONSOLIDATED FINANCIAL STATEMENTS**  
**AS OF DECEMBER 31, 2018 AND COMPARATIVE INFORMATION**

(Amounts expressed in thousands of Argentine Pesos, except as otherwise indicated)

**Derecognition of financial assets**

A financial asset (or, if applicable, part of a financial asset or part of a group of similar financial assets) is derecognized from the statement of financial position when:

- The contractual rights to receive the cash flows generated by the asset have expired or;
- Contractual rights over the cash flows generated by the asset have been transferred, or an obligation to pay a third party all of these cash flows without a significant delay has been assumed, through a transfer agreement (pass-through arrangement), and (a) substantially all the risks and benefits inherent to ownership of the asset have been transferred; or (b) substantially all the risks and rewards of ownership of the asset have not been transferred or retained, but control over the asset has been transferred.

When the contractual rights to receive the cash flows generated by the asset have been transferred, or a transfer agreement has been entered into, but neither all the risks and benefits inherent to ownership of the asset have been substantially transferred or retained, nor have been transferred control over it, that asset will continue to be recognized to the extent of the Group's continued involvement in the asset. In that case, the Group will also recognize the related liability. The transferred asset and the related liability will be measured in a manner that reflects the rights and obligations that the Group has retained.

**Impairment of financial assets**

IFRS 9 introduces an "expected credit loss" ("ECL") model. This requires considerable judgment regarding how changes in economic factors affect ECLs, which are determined on a weighted average basis. The ECLs arise from the difference between the contractual cash flows and the cash flows at present value that the Group expects to receive.

The new impairment model is applicable to financial assets measured at amortized cost or at fair value with changes through other comprehensive income, except for investments in equity instruments, and to the assets from contracts recognized under IFRS 15.

Under IFRS 9, allowances for losses will be measured using one of the following bases:

- 12-month ECL: These are ECLs that result from possible default events within 12 months after the reporting date;
- ECL during the life of the asset: These are ECLs that result from possible events of default during the expected life of a financial instrument.

Given the nature of the clients with which the Group operates and based on the above-mentioned criteria, the Group did not identify significant expected credit losses, during the asset lifetime.

In the case of financial investments and, in accordance with the current investment policies, the Group monitors the credit rating and the credit risk that these instruments have. Based on the analysis made, the Group did not identify that an impairment should be recorded in this type of instrument.

**2.3.9.2. Financial liabilities - Recognition and measurement**

Financial liabilities are initially recognized at their fair value less the transaction costs incurred. Because the Group does not have financial liabilities whose characteristics require the recognition at their fair value, according to IFRS, after their initial recognition, financial liabilities are measured at amortized cost. Any difference between the financing received (net of transaction costs) and the repayment value is recognized in the consolidated statement of comprehensive income over the life of the related debt instrument, using the effective interest rate method.

At the closing date of these consolidated financial statements, the Group's financial liabilities at amortized cost include Accounts payable, Other liabilities and Loans.

**Derecognition of financial liabilities**

The Group derecognizes a financial liability when the obligation specified in the corresponding contract has been paid or canceled, or has expired.

When one financial liability is replaced with another one with the same counterparty with substantially different conditions, or if the conditions of an existing liability change substantially, that exchange or modification is treated by derecognizing the original financial liability and recognizing a new financial liability, and the difference is recognized as financial income or expense in the statement of comprehensive income.

**YPF ENERGÍA ELÉCTRICA SOCIEDAD ANÓNIMA**  
**NOTES TO THE CONSOLIDATED FINANCIAL STATEMENTS**  
**AS OF DECEMBER 31, 2018 AND COMPARATIVE INFORMATION**  
(Amounts expressed in thousands of Argentine Pesos, except as otherwise indicated)

**2.3.9.3. Offsetting financial assets and financial liabilities**

Financial assets and financial liabilities are offset and the net amount presented in the statement of financial position if, and only if, there is a currently enforceable legal right to offset the recognized amounts and there is an intention to settle on a net basis, or to realize the assets and settle the liabilities simultaneously.

**2.3.9.4. Financial assets and liabilities with related parties**

Assets and liabilities with related parties are recognized initially at fair value plus directly attributable transaction costs. As long as those transactions have not been performed at arms' length principle, any difference arising at initial recognition between fair value and the consideration given or received in return shall be considered as an equity transaction (capital contribution or payment of dividends, which will depend on whether it is positive or negative).

Following initial recognition, these receivables and payables are measured at their amortized cost through the effective interest rate method. The amortization is included in finance income or costs in the comprehensive income statement of income.

**2.3.9.5. Derivative financial instruments and hedge accounting**

**Initial recognition and subsequent measurement**

The derivative financial instruments used by the Group are initially recognized at fair value on the date on which a derivatives contract is entered into and are subsequently remeasured at fair value. Derivatives are carried as financial assets when the fair value is positive and as financial liabilities when the fair value is negative.

The method to recognize the loss or gain resulting from the change in fair value depends on whether the derivative has been designated as a hedging instrument and, if so, on the nature of the item being hedged. The Company may designate certain derivatives as:

- fair value hedges;
- cash flow hedges.

At inception date, the Group documents the relationship between the hedging instruments and the hedged items, as well as their objectives for risk management and the strategy to carry out various hedging transactions. It also documents its evaluation, both at the beginning and on an ongoing basis, of whether the derivatives used in hedging transactions are highly effective in offsetting changes in the fair value or in the cash flows of the hedged items.

**Fair value hedge**

Changes in the fair value of derivatives that are designated and qualify as fair value hedges are recorded in the statement of comprehensive income, along with any change in the fair value of the hedged asset or liability that is attributable to the hedged risk.

**Cash flow hedge**

The effective portion of changes in the fair value of the derivatives that are designated and qualify as cash flow hedges are recognized in Other Comprehensive Income. The loss or gain relating to the non-effective part is recognized immediately in the statement of comprehensive income under "Net financial results".

The amounts accumulated in Other Comprehensive Income are taken to the statement of comprehensive income in the years in which the hedged item affects the result of the year. In the case of interest rate hedges, this means that the amounts recognized in the equity are reclassified to results in "Net financial results", as the interest on the associated debts accrues.

As of December 31, 2018, the Group maintains derivative hedging instruments in order to reduce the risk arising from variation in interest rates.

Interest rate swaps or hedge contracts are measured at their current value at the end of each year and are exposed as assets or liabilities depending on the rights and obligations arising from the respective contracts. Interest rate swaps contracts have been classified as effective cash flow hedges. Changes in the accounting measurement of swap contracts are recognized in the shareholders' equity in "Other comprehensive income". These recognized changes in shareholders' equity are reclassified to the result of the year in which the interests of the loan with variable rate object of coverage are recognized in the statement of comprehensive income.

If the hedging instrument expires or is sold, resolved or terminated or exercised without successive replacement or renewal (as part of the hedging strategy), or if its designation as a hedge is revoked, or if the hedge no longer meets the requirements



**YPF ENERGÍA ELÉCTRICA SOCIEDAD ANÓNIMA**  
**NOTES TO THE CONSOLIDATED FINANCIAL STATEMENTS**  
**AS OF DECEMBER 31, 2018 AND COMPARATIVE INFORMATION**

(Amounts expressed in thousands of Argentine Pesos, except as otherwise indicated)

to apply hedge accounting, any accumulated gain or loss previously recognized in the other comprehensive income remains separate in equity until the expected transaction takes place.

**2.3.10. Inventories**

Inventories are valued at the lower of acquisition cost and net realizable value. In the estimation of the net realizable value, the destination of the assets to be measured and the movements of the items of slow moving are taken into account.

Inventories correspond to Consortium Ramos discontinued operation (Note 3.a).

Inventories balance is not higher than its net realizable value at the corresponding dates.

**2.3.11. Cash and cash equivalents**

Cash is deemed to include both cash on hand and bank deposits on demand. Cash equivalents are deemed to include short-term investments with significant liquidity and free availability that, subject to no previous notice or material cost, may be easily converted into a specific cash amount that is known with a high degree of certainty upon the acquisition, are subject to an insignificant risk of changes in value, maturing up to three months after the date of the related acquisitions, and whose main purpose is not investment or any other similar purpose, but settling short-term commitments.

For the purpose of the consolidated statement of financial position and the consolidated statement of cash flows, cash and cash equivalents comprise cash in hand, deposit held at call with banks and on other short-term highly liquidity investments with original maturities of three months or less.

They do not include bank overdrafts.

**2.3.12. Provisions**

Provisions are recognized when the Group has a present obligation (legal or implied) as a result of a past event, it is probable that an outflow of resources embodying economic benefits will be required to settle the obligation and a reliable estimate can be made of the amount of the obligation. Where the Group expects some or all of a provision to be reimbursed, for example under an insurance contract, the reimbursement is recognized as a separate asset but only when the reimbursement is virtually certain. The expense relating to any provision is presented in the statement of comprehensive income under the item that better reflects the nature of the provision net of any reimbursement to the extent that the latter is virtually certain.

If the effect of the time value of money is material, provisions are discounted using a current pre-tax market rate that reflects, where appropriate, the risks specific to the liability. Where discounting is used, the increase in the provision due to the passage of time is recognized as a finance cost in the statement of comprehensive income under the caption "Net financial results".

– *Provision for lawsuits and claims*

In the ordinary course of business, the Group is exposed to claims of different natures (e.g., commercial, labor, tax, social security, foreign exchange or customs claims) and other contingent situations derived from the interpretation of current legislation, which could result in a loss, the materialization of which depends on whether one more events occur or not. In assessing these situations, Management uses its own judgment and advice from its legal counsel, both internal and external, as well as the evidence available as of those dates. If the assessment of the contingency reveals the likelihood of the materialization of a loss and the amount can be reliably estimated, a provision for lawsuits and claims is recorded as of the end of each year .

– *Provision for well abandonment obligations*

Costs related to hydrocarbon well abandonment obligations are capitalized at their discounted value along with the related assets, and are depreciated using the unit-of-production method, and a liability for the same amount is recognized. Re-estimations of the payable amounts are performed upon consideration of the current costs incurred in abandonment obligations on a field-by-field basis or other external available information if abandonment obligations were not performed. Due to the number of wells in operation and/or not yet abandoned, as well as the complexity with respect to different geographic areas where the wells are located, actual costs incurred in abandonment activities, weighted by the complexity level of the wells, are used for estimating the costs of the wells pending abandonment. Current costs incurred are the best source of information in order to make the best estimate of asset retirement obligations. Future changes in the costs mentioned above, the useful life of the wells and the estimate of abandonment obligations, as well as changes in regulations, which are not possible to be predicted at the date of issuance of these consolidated financial statements, could affect the value of the abandonment obligations and, consequently, the related asset, affecting the results of future operations. During the year ended December 31, 2018 the Company discontinued this activity (Note 3.a)).

**YPF ENERGÍA ELÉCTRICA SOCIEDAD ANÓNIMA**  
**NOTES TO THE CONSOLIDATED FINANCIAL STATEMENTS**  
**AS OF DECEMBER 31, 2018 AND COMPARATIVE INFORMATION**

(Amounts expressed in thousands of Argentine Pesos, except as otherwise indicated)

**2.3.13. Contingent liabilities**

A contingent liability is: (i) a possible obligation that arises from past events and whose existence will be confirmed only by the occurrence or non-occurrence of one or more uncertain future events not wholly within the control of the entity; or (ii) a present obligation that arises from past events but is not recognized because: (a) it is not probable that an outflow of resources embodying economic benefits will be required to settle the obligation; or (b) the amount of the obligation cannot be measured with sufficient reliability.

A contingent liability is not recognized in the financial statements; it is reported in notes, unless the possibility of an outflow of resources to settle such liability is remote. For each type of contingent liability as of the end of each year, the Group shall disclose (i) a brief description of the nature of the obligation and, if possible, (ii) an estimate of its financial impact; (iii) an indication of the uncertainties about the amount or timing of those outflows; and (iv) the possibility of obtaining potential reimbursements.

**2.3.14. Contingent assets**

A contingent asset is a possible asset that arises from past events and whose existence will be confirmed only by the occurrence or non-occurrence of one or more uncertain future events not wholly within the control of the Group.

A contingent asset is not recognized in the financial statements; it is reported in notes only where an inflow of economic benefits is probable. For each type of contingent asset as of the end of each year, the Group shall disclose (i) a brief description of the nature thereof and, if possible, (ii) an estimate of its financial impact.

**2.3.15. Employee benefits**

The Group recognizes short-term benefits to employees, such as salary, vacation pay, bonuses, among others, on an accrued basis and includes the benefits arising from collective bargaining agreements. All these benefits are included in "Salaries and social security".

The Group also awards bonus for objectives and performance. These programs reach certain Group employees. They are based on the fulfillment of corporate objectives, business unit and individual performance. They are determined based on the annual remuneration of each employee, the calculation of certain indicators related to compliance with the aforementioned objectives and the performance evaluation, and are paid in cash.

**2.3.16. Investment in associates and joint ventures**

The Group's investments in associates and joint ventures are accounted for using the equity method. An associate is an entity over which the Group has significant influence or joint control. Significant influence is the power to participate in the financial and operating policy decisions of the investee, but is neither control nor joint control.

According to the equity method, investments in associates are originally recognized in the statement of financial position at cost, plus (less) the changes in the Group's ownership interests in the associates' net assets subsequent to the acquisition date. If any, goodwill relating to the associate is included in the carrying amount of the investment and it is neither amortized nor individually tested for impairment.

If the cost of the investments is lower than the proportional share on the on the fair value associate's assets and liabilities as of the date of acquisition, a gain is recognized in the year in which the investment was acquired.

The statement of comprehensive income reflects the share of the results of operations of the associates and joint ventures adjusted on the basis of the fair values estimated as of the date on which the investment was recognized. When there has been a change recognized directly in the equity of the associates, the Group recognizes its share of any changes and includes them, when applicable, in the statement of changes in shareholders' equity.

The Group's share of profit in the associates and joint ventures is shown in a single line on the statement of comprehensive income. This share of profit includes income or loss after taxes of the associates and joint ventures.

The financial information of the associates and joint ventures is prepared for the same reporting period as the Group. When necessary, adjustments are made to bring the accounting policies of the associates and joint ventures in line with those of the Group.

After the application of the equity method, the Group determines whether it is necessary to recognize impairment losses on its investment in its associates and joint ventures. As of the end of each year, the Group determines whether there is objective evidence that the value of the investment in the associates has been impaired. If such was the case, the Group estimates the

**YPF ENERGÍA ELÉCTRICA SOCIEDAD ANÓNIMA**  
**NOTES TO THE CONSOLIDATED FINANCIAL STATEMENTS**  
**AS OF DECEMBER 31, 2018 AND COMPARATIVE INFORMATION**

(Amounts expressed in thousands of Argentine Pesos, except as otherwise indicated)

impairment loss as the difference between the recoverable amount of the investment in the associates and its carrying value, and recognizes the loss as "Income from equity interest in associates" in the statement of comprehensive income.

Upon loss of significant influence over an associate, and joint ventures the Group measures and recognizes any retained investment at its fair value. If such was the case, any difference between the carrying amount of the investment in the associate and the fair value on any retained investment, as well as the disposal proceeds, are recognized in the statement of comprehensive income.

The information related to associates and joint ventures is included in Note 8.

**2.3.17. Discontinued operations**

The Group classifies non-current assets and groups of assets as held for sale if their carrying amounts will be recovered principally through a sale transaction or its distribution to the shareholders rather than through continuing use. Such assets are measured at the lower of their carrying amount and fair value less costs to sell. Costs to sell are the incremental costs directly attributable to the disposal, excluding finance costs and income tax expense.

The criteria to classify as held for sale is regarded as met only when the sale is highly probable and the asset or disposal group is available for immediate sale in its present condition. Actions required to complete the sale should indicate that it is unlikely that significant changes to the transaction will be made or that the decision to sale will be withdrawn. Management must be committed to the plan to sell the asset and the sale expected to be completed within one year from the date of the classification.

Property, plant and equipment are not depreciated nor amortized once classified as held for sale.

Assets and liabilities classified as held for sale are presented separately in the consolidated statement of financial position.

A disposal group qualifies as discontinued operation if:

- It is a component of the Group that represents a CGU or a group of CGU;
- It is classified as held for sale or as for distribution to equity holders, or it has already been disposed as such, and;
- It represents a separate major line of business or geographical area of operations or it is a subsidiary acquired exclusively with a view to resale it.

Discontinued operations are excluded from the results of continuing operations and are presented as a single amount as income or loss after tax from discontinued operations in the consolidated statement of comprehensive income.

Additional disclosures are provided in Note 18. All other notes to the consolidated financial statements include amounts for continuing operations, unless otherwise indicated.

**2.3.18. Leases**

The decision whether an agreement is or contains a lease is based on the substance of the agreement, whether compliance with the agreement depends on the use of an asset or of specific assets, or whether the agreement transfers the right to use the asset.

**- Operating leases**

Leases are classified as operating leases when the lessor retains substantially all the risks and benefits inherent in the property of the leased assets. Operating lease costs are recognized by the straight-line method in the statement of comprehensive and are related to real estate and equipment leases that are included in "Production costs" and "Administrative and selling expenses" in the consolidated statement of comprehensive income.

**- Finance leases**

Leases are classified as finance leases when the lessor transfers substantially all the risks and benefits inherent in the property of the leased assets.

In finance leases, an asset and a liability are recognized at inception in the statement of financial position at their fair value or, if lower, at the present value of the minimum lease payments.

**YPF ENERGÍA ELÉCTRICA SOCIEDAD ANÓNIMA**  
**NOTES TO THE CONSOLIDATED FINANCIAL STATEMENTS**  
**AS OF DECEMBER 31, 2018 AND COMPARATIVE INFORMATION**

(Amounts expressed in thousands of Argentine Pesos, except as otherwise indicated)

Lease payments are apportioned between finance expenses and reduction of the lease obligation so as to achieve a constant rate of interest on the remaining balance of the liability. Finance expenses are recognized immediately in profit or loss, unless they are directly attributable to qualifying assets, in which case they are capitalized in accordance with the Group's general policy on borrowing costs. Contingent rentals are recognized as expenses in the periods in which they are incurred.

**2.3.19. Shareholders' equity**

Shareholders' equity items were valued pursuant to the professional accounting standards effective as of the date of transition. The movements in this account were recognized according to the decisions reached by shareholders' meetings, legislation or regulations.

**Capital stock and capital adjustment**

It includes the contributions made by the shareholders represented by shares and includes the shares outstanding at their face value. The adjustment required under previous Generally Accepted Accounting Principles to state this account in constant Argentine pesos is disclosed in the "Capital adjustment" account in 2017 and was transferred to "Subscribed capital" account during such year.

**Share premium**

It is related to the difference between the capital increases subscribed and the related face value of the shares issued.

**Other shareholders contributions**

Includes the effects of the transactions made with entities under the Group's common control (Note 3.a).

**Legal reserve**

According to the provisions of General Business Associations Law, the Company is required to set up a legal reserve of at least 5% of the income arising, from the profit for the year, prior-year adjustments, the transfers of other comprehensive income to retained earnings and accumulated losses of prior years until it reaches 20% of the subscribed capital.

**Voluntary reserve**

Corresponds to the allocation made by the Shareholders' Meeting of the Company, by which a specific amount is destined to constitute a reserve for future investments.

**Reserve for future dividends**

Corresponds to the allocation made by the Shareholders' Meeting of the Company, by which a specific amount is destined to constitute a reserve for future dividends.

**Other comprehensive income**

Includes income and expenses recognized directly in shareholders' equity accounts and the transfer of such items from equity accounts to the income statement of the year or to retained earnings, as defined by IFRS.

**YPF ENERGÍA ELÉCTRICA SOCIEDAD ANÓNIMA**  
**NOTES TO THE CONSOLIDATED FINANCIAL STATEMENTS**  
**AS OF DECEMBER 31, 2018 AND COMPARATIVE INFORMATION**

(Amounts expressed in thousands of Argentine Pesos, except as otherwise indicated)

The evolution of the item is detailed below.

	Other comprehensive income		Total
	Currency adjustment translation	Changes in derivative instruments' fair value (1)	
<b>Balance as of January 1, 2017</b>	-	-	-
Currency adjustment translation	542,191	-	542,191
Net variation of the year	542,191	-	542,191
<b>Balance as of December 31, 2017</b>	<b>542,191</b>	<b>-</b>	<b>542,191</b>
Currency adjustment translation	11,170,660	-	11,170,660
Income from hedging instruments	-	49,483	49,483
Less: Income reclassification for valuation of hedging instruments charged to results of the year	-	(10,325)	(10,325)
Income tax related to components of other comprehensive results for the year	-	(12,767)	(12,767)
Net variation of the year	11,170,660	26,391	11,197,051
<b>Balance as of December 31, 2018</b>	<b>11,712,851</b>	<b>26,391</b>	<b>11,739,242</b>

(1) Will be reclassified to net income in subsequent years.

In addition, as established by CNV regulations, when the other comprehensive income balance is positive it should not be distributed, converted into equity or used to compensate accumulated losses, and when the balance is negative, a restriction to the distribution of retained earnings to the shareholders for up to that amount applies.

### Retained earnings

Includes retained earnings with no specific allocation that may be distributed by a decision reached by the Shareholders' Meeting, provided that there are no legal restrictions.

Moreover, it comprises retained earnings from prior years, the amounts transferred from other comprehensive income and adjustment to prior-year results due to the application of professional accounting policy.

On September 13, 2012, the CNV issued General Resolution No. 609 relative to the positive difference resulting from the opening balance of the retained earnings disclosed in the financial statements for the first fiscal year-end in which IFRS are applied and the closing balance of retained earnings at the last fiscal year-end under the previous accounting principles. Under this resolution, an entity filing its financial statements under the IFRS for the first time should re-allocate the positive difference arising from the application of the IFRS to a special reserve, which may only be used for capitalization purposes or to absorb negative balances of the "Retained Earnings" account, and not to make distributions in cash or in kind among the entity's shareholders or owners. The Shareholders' Meeting at which the financial statements ended December 31, 2018, will be considered will have to make a decision regarding the application of the said resolution.

### 2.3.20. Information by operating segment

For management purposes, the Group is organized as a single business segment to generate and sell electric energy. The Group discloses only the information about this activity in "Operating income (loss)" on the consolidated statement of comprehensive income.

### 2.3.21. Business combination

Business combinations are accounted for by applying the acquisition method when the Group takes effective control over the acquired company.

The Group recognizes in its financial statements the identifiable assets acquired, the liabilities assumed, any non-controlling interest and goodwill, if any, in accordance with IFRS 3.

The acquisition cost is measured as the sum of the consideration transferred, measured at fair value at its acquisition date and the amount of any non-controlling interest in the acquired entity. The Group will measure the non-controlling interest in the acquired entity at fair value or at the non-controlling interest's proportionate share of the acquired entity's identifiable net assets.

**YPF ENERGÍA ELÉCTRICA SOCIEDAD ANÓNIMA**  
**NOTES TO THE CONSOLIDATED FINANCIAL STATEMENTS**  
**AS OF DECEMBER 31, 2018 AND COMPARATIVE INFORMATION**

(Amounts expressed in thousands of Argentine Pesos, except as otherwise indicated)

If the business combination is achieved in stages, the Group will remeasure its previously held equity interest in the acquired entity at its acquisition date fair value and recognize a gain or loss in the consolidated statement of comprehensive income.

The goodwill cost is measured as the excess of the consideration transferred over the identifiable assets acquired and liabilities assumed net by the Group. If this consideration is lower than the fair value of the assets identifiable and liabilities assumed, the difference is recognized in the consolidated statement of comprehensive income.

#### **2.4. Judgements, significant accounting estimates and assumptions**

The preparation of the Group's consolidated financial statements requires Management to make significant estimates and assumptions that affect the recorded amounts of revenues, expenses, assets and liabilities, and the disclosure of contingent assets and liabilities as of the end of each year. In this sense, the uncertainties related to the estimates and assumptions adopted could give rise in the future to final results that could differ from those estimates and require significant adjustments to the amounts of the assets and liabilities affected.

The key assumptions concerning the future and other key sources of estimation as of the end of each year, that have a significant risk of causing a material adjustment to the carrying amounts of assets and liabilities within the next financial year, are described below. The Group based its accounting assumptions and significant estimates on parameters available when the consolidated financial statements were prepared. Existing circumstances and assumptions about future developments, however, may change due to market changes or circumstances arising beyond the control of the Group. Such changes are reflected in the assumptions when they occur.

The significant estimates used by management are mentioned below:

- *Recoverability of property, plant and equipment:*

At each reporting date the Group assess if there is an indicator that Property, Plant and Equipment may be impaired. Impairment exists when the carrying value of an asset or CGU exceeds its recoverable amount, which is the higher of its fair value less costs of disposal and its value in use. The value in use calculation is based on a Discounted Cash Flow (DCF) method. The cash flows cover the useful life of the assets. The recoverable amount is sensitive to the discount rate used for the DCF model as well as the expected future cash-inflows.

- *Income tax and deferred income tax*

The proper assessment of income tax expenses depends on several factors, including interpretations related to tax treatment for transactions and/or events that are not expressly provided for by current tax law, as well as estimates of the timing and realization of deferred income taxes. The actual collection and payment of income tax expenses may differ from these estimates due to, among others, changes in applicable tax regulations and/or their interpretations, as well as unanticipated future transactions affecting the Group's tax balances.

- *Business combination*

The application of the acquisition method involves the measurement at fair value of the identifiable assets acquired and the liabilities assumed in the business combination at the acquisition date.

For the determination of the fair value of the identifiable assets and liabilities, the Group uses the valuation approach considered most representative for each element. Among them are: i) the income approach, which through valuation techniques converts future amounts into a single present amount (discounted) ii) the market approach through the methodology of comparable transactions and iii) cost approach through the use of depreciated replacement values.

In the selection of the approach to be used and the estimation of future cash flows, critical judgment is required by Management. The actual cash flows and values can vary significantly from the expected future cash flows and the related values obtained through the aforementioned valuation techniques.

- *Functional Currency*

The Company's Management applies its professional judgment to determine its functional currency and that of its subsidiaries. The judgment is made mainly with respect to the currency which influences and determines the sales prices, the generating costs, material, investment and other costs, as well as the financing and collections resulting from their operating activities.

**YPF ENERGÍA ELÉCTRICA SOCIEDAD ANÓNIMA**  
**NOTES TO THE CONSOLIDATED FINANCIAL STATEMENTS**  
**AS OF DECEMBER 31, 2018 AND COMPARATIVE INFORMATION**

(Amounts expressed in thousands of Argentine Pesos, except as otherwise indicated)

- *Probability of occurrence and the amount of liabilities related to lawsuits and claims:*

The Group based its estimates on the opinions of its legal counsel available when the consolidated financial statements were prepared. Existing circumstances and assumptions, however, may change due to changes in circumstances arising beyond the control of the Group.

**2.5. First-time adoption of IFRS**

**2.5.1. Information required for the year ended December 31, 2018**

As mentioned in Note 2.1, the Group adopted IFRS, as issued by the IASB, in its entirety from the year beginning on January 1, 2018.

The adoption of these standards originated changes in the accounting policies applied by the Group and were included in the financial statements for the year ended December 31, 2018. Additionally, the presentation of the financial statements was restated as of December 31, and January 1<sup>st</sup>, 2017, for comparative purposes, due to IFRS's adoption.

The accounting policies applied as of the transition date comply with the current IFRS in the year ended December 31, 2018, in accordance with the requirements of IFRS 1.

In accordance with the requirements of IFRS 1, the main adjustments and the reclassifications of the transition to IFRS are explained below, and the following reconciliations related to the transition are presented:

- a) Between the equity determined in accordance with the PAS and the equity determined in accordance with IFRS, as of January 1, 2017, (date of transition to IFRS), and December 31, 2017;
- b) Between the net profit in accordance with the PAS for the year ended December 31, 2017, and the total comprehensive income in accordance with the IFRS for the same years.

In the preparation of these reconciliations, the Company's Management has considered those IFRS that are applicable in the preparation of the first financial statements presented in accordance with IFRS for the fiscal year ending on December 31, 2018.

**2.5.2. Mandatory exceptions to the retroactive application of certain IFRS**

**2.5.2.1. Estimates**

The judgments, estimates and significant accounting assumptions made by the Company's Management to determine the amounts according to IFRS as of January 1, 2017 (date of transition to IFRS) and as of December 31, 2017, were consistent with those made at those dates according to PAS, as described in Note 2.4. and reflect the existing conditions at the respective dates.

**2.5.3. Exemptions used in the application of certain IFRS**

**2.5.3.1. Deemed cost of Property, plant and equipment:**

Property, plant and equipment have been measured at the transition date in the functional currency defined by each company of the Group according to the following:

Property, plant and equipment of the Company, as of January 1, 2017, measured according to PAS, have been adopted as deemed cost and remeasured into U.S. dollars using the exchange rate in effect on that date. This is a consequence of the fact that, on February 1, 2017, entered into force Resolution SEE 19/2017, which determined the remuneration of generators in US dollars. Considering that the Company only prepare financial information at the end of each quarter, for the remeasurement to the functional dollar currency, assets, liabilities and results have been considered as of January 1, 2017, the date of transition to IFRS. Had the property, plant and equipment been measured as of February 1, 2017, they would not have deferred significantly, because the variation of exchange rates between both dates has remained stable.

**YPF ENERGÍA ELÉCTRICA SOCIEDAD ANÓNIMA**  
**NOTES TO THE CONSOLIDATED FINANCIAL STATEMENTS**  
**AS OF DECEMBER 31, 2018 AND COMPARATIVE INFORMATION**

(Amounts expressed in thousands of Argentine Pesos, except as otherwise indicated)

**2.5.4. Explanation of adjustments and reclassifications at the transition date to IFRS**

**2.5.4.1. Equity reconciliation as of January 1, 2017 (transition date), and December 31, 2017**

	<u>01.01.2017</u>	<u>12.31.2017</u>
<b>Equity as per PAS</b>	1,735,873	3,440,991
Transition adjustments		
A – Property, plant and equipment and related advances to suppliers	-	370,522
B - Investment in associates and joint ventures	11,532	197,082
C - Income tax effect	-	(95,208)
<b>Equity as per IFRS</b>	<u><b>1,747,405</b></u>	<u><b>3,913,387</b></u>

**Effect of the application of the functional and presentation currency**

Under previous PAS, the financial statements are presented in pesos (reporting currency) recognizing the effects of variations in the purchasing power of money in a comprehensive manner by applying the method of restatement in constant currency established by Technical Resolution No. 6 and No. 17, as amended by Technical Resolution No. 39 and by Interpretation No. 8, rules issued by the Argentine Federation of Professional Councils in Economic Sciences (FACPCE) and approved by the Professional Council of Economic Sciences of the City of Buenos Aires. Foreign currency transactions are recorded in pesos at the exchange rate prevailing at the date of each transaction. Exchange differences arising on monetary items in foreign currencies are recognized in statement of comprehensive income in the year in which they arise.

Under IFRS, companies should determine their functional currency according to the criteria established by IAS 21, "The Effects of Changes in Foreign Exchange Rates", which may differ from their reporting currency. According to the provisions of that standard, the management has defined the U.S. dollar as the functional currency of the Group. Accordingly, the shareholders' equity as of January 1, December 31, 2017, prepared under previous PAS, have been remeasured into U.S. dollars according to the procedure set out in IAS 21 and IFRS 1, with the objective of generating the same accounting information that would have been reported if the accounting records were kept in the functional currency.

According to the established procedures, monetary assets and liabilities as of January 1<sup>st</sup> and December 31, 2017, are remeasured at the closing exchange rates. Non-monetary items, which are measured in terms of historical cost, as well as income and expenses, are remeasured using the exchange rate at the date of the relevant transaction. The results of the remeasurement into U.S. dollars of monetary assets and liabilities in currencies different from U.S. dollar are recognized as income (expense) in the year in which they arise.

Additionally, according to General Resolution No. 562 of the CNV, the Company must file its financial statements in pesos. Therefore, the amounts obtained from the process above mentioned, need to be converted into pesos, following the criteria set forth in IAS 21. As a result, assets and liabilities have been translated to the reporting currency, at the closing exchange rate, income and expenses have been translated at the exchange rate at the date of each transaction (or, for practical reasons and when exchange rates do not fluctuate significantly, the average exchange rate for each month) and the exchange differences resulting from this process have been reported in Other Comprehensive Income for the year.

**a. Property, plant and equipment and advances to suppliers related**

According to the methodology mentioned above, the Company has valued its properties, plant and equipment, in its functional currency, taking into consideration the exception mentioned in the section 2.5.3.1 above and has subsequently converted them into pesos. Based on that valuation, Property, plant and equipment of the Company have been increased in the amounts of 370,522 as of December 31, 2017.

**b. Investments in associates and joint ventures**

Corresponds to the effect of the valuation in functional currency dollar, to investments in which the Company has joint control. Based on that valuation, Investments in associates and joint ventures of the Company have been increased in the amounts of 11,532, and 197,082 as of January 1<sup>st</sup> and December 31, 2017, respectively

**c. Income tax**

Corresponds to the income tax of the valuation differences referred to in previous section.

Under previous PAS, when there were timing differences between the accounting value of the assets and liabilities and their tax basis, deferred income tax assets or liabilities were recognized.



**YPF ENERGÍA ELÉCTRICA SOCIEDAD ANÓNIMA**  
**NOTES TO THE CONSOLIDATED FINANCIAL STATEMENTS**  
**AS OF DECEMBER 31, 2018 AND COMPARATIVE INFORMATION**

(Amounts expressed in thousands of Argentine Pesos, except as otherwise indicated)

Under IFRS, according to the provisions of IAS 12, "Income Taxes", a deferred tax asset or liability exists when there are tax deferred earnings to be recovered or settled in future periods related to deductible or taxable temporary differences, which are generated when there is a difference between the carrying amount of an asset or liability in the statement of financial position and its tax base. Taxable temporary differences are temporary differences that give rise to taxable amounts in determining taxable profit (tax loss) of future periods when the asset's carrying amount is recovered or the liability is settled, and deductible temporary differences are temporary differences that give rise to amounts that are deductible in determining taxable profit (tax loss) of future periods when the asset's carrying amount is recovered or the liability is settled.

The effect of applying the current tax rate on the difference generated between the tax basis of Property, plant and equipment and their book value under IFRS, measured in its functional currency and converted into pesos as described in previous section, with respect to the book value under PAS, resulted in a decrease in Shareholders' equity of 95,208 as of December 31, 2017.

**2.5.4.2. Net profit and comprehensive income reconciliation for year ended December 31, 2017**

	<b>12.31.2017</b> <b>(12 months)</b>
<b>Net profit as per PAS</b>	928,085
Transition adjustments	
A - Exchange difference	124,188
B - Depreciation of property, plant and equipment	(3,188)
C - Investment in associates and joint ventures	(107,120)
D - Income tax effects	(95,208)
<b>Income for the year/year as per IFRS <sup>(1)</sup></b>	<b>846,757</b> <sup>(2)</sup>
E - Currency adjustment translation	542,191
<b>Other comprehensive income for the year/ year as per IFRS <sup>(1)</sup></b>	<b>1,388,948</b>

(1) Includes incomes from discontinued operations of 193,987 for the fiscal year ended December 31, 2017.

(2) Earnings per share for the year ended December 31, 2017 was 0.559. The weighted average number of ordinary shares was 1,515,936.

**a) Exchange differences**

Corresponds to the elimination of exchange differences recorded under PAS originated by monetary assets and liabilities denominated in currencies other than the peso, and the recognition of the exchange differences corresponding to the measurement of monetary assets and liabilities denominated in currencies other than U.S. dollar, as a result of the application of the functional currency concept previously mentioned in note 2.5.4.1.

**b) Depreciation of fixed assets:**

Corresponds to the difference in depreciations charged to expense in the year, derived from the valuation of property, plant and equipment, as a result of the application of the concept of functional currency.

**c) Investment in associates and joint ventures**

Corresponds to the effect of the valuation in functional currency dollar, to investments in which the Company has joint control.

**d) Income tax effects**

Corresponds to the income tax as a result of the valuation differences of fixed assets.

**e) Translation adjustment**

Includes the adjustment effect of the conversion process from the Company's functional currency (U.S. dollar) into the Company's reporting currency (peso), according to the methodology provided by IAS 21.

**YPF ENERGÍA ELÉCTRICA SOCIEDAD ANÓNIMA**  
**NOTES TO THE CONSOLIDATED FINANCIAL STATEMENTS**  
**AS OF DECEMBER 31, 2018 AND COMPARATIVE INFORMATION**

(Amounts expressed in thousands of Argentine Pesos, except as otherwise indicated)

**2.5.4.3. Consolidated statement of cash flow**

The cash and equivalents at the beginning and end of year ended December 31, 2017 remeasured into U.S. dollar and translated into Argentine pesos under IFRS are presented below.

	<u>For the year ended December 31, 2017</u>
Net cash flows from operating activities	901,168
Net cash flows used in investing activities	(3,004,469)
Net cash flows from financing activities	1,522,203
Decrease in cash and cash equivalents	(581,098)
Cash and cash equivalents at the beginning of the year	651,447
Effect of exchange difference variations on cash and cash equivalents	68,733
<b>Cash and cash equivalent at the end of the year</b>	<b><u>139,082</u></b>

The statements of cash flow for year ended December 31, 2017 have been modified mainly due to the proportional deconsolidation of investments in joint ventures, which generates a decrease in cash and cash equivalents at the beginning of the year 2017 of 142,002 and a decrease in cash and cash equivalents as of the end of the year of 431,486. Additionally, it has produced an increase in net cash flows from operating activities of 234,523, a decrease in net cash flows used in investing activities of 1,831,851 and a decrease in net cash flows from financing activities of 2,424,592 for the year ended December 31, 2017.

**2.5.4.5. Main reclassifications**

**a) Investment in associates and joint ventures**

Under PAS, investments in joint ventures were consolidated using the proportional consolidation. Under IFRS, these investments are recorded using the equity method.

**b) Advances for purchases of property, plant and equipment**

Under PAS, advances for purchases of property, plant and equipment were classified in "Property, plant and equipment". Under IFRS, those advances are classified as "Other non-current receivables".

**2.6. IFRS issued not yet effective**

The following is a list of the new and / or amended standards and interpretations issued but not in effect as of the date of issuance of these consolidated financial statements. In this regard, only the new and / or modified standards and interpretations that the Group reasonably foresees that will be applicable in the future are indicated. In general, the Group intends to adopt these standards when they become effective.

**2.6.1. Leases - IFRS 16**

Nature of modification

IFRS 16 was issued in January 2016. Under this standard all leases will be recognized in the statement of financial position by lessees, since the distinction between finance and operating leases is eliminated. The new standard recognizes a financial asset (the right to use the leased item) and a financial liability to pay the lease. The only exceptions are short-term and low value leases.

Description of IFRS 16 requirements

IFRS 16 is in effect for reporting periods beginning on January 1, 2019 and its implementation in advance is permitted for entities that use IFRS 15 "Revenue from ordinary activities from contracts entered into with customers".

It will replace IAS 17 "Leases" and its interpretations after the effective date thereof.

IFRS 16 sets out the principles required for the recognition, measurement, presentation and disclosure of leases. The purpose thereof is to ensure that lessees and lessors provide relevant information in a way that faithfully represents those transactions. The changes incorporated by such standard mainly impact the accounting of tenants.

This standard applies to all leases, including leases of rights-of-use assets in a sublease, with the exception of specific leases covered by other standards:

**YPF ENERGÍA ELÉCTRICA SOCIEDAD ANÓNIMA**  
**NOTES TO THE CONSOLIDATED FINANCIAL STATEMENTS**  
**AS OF DECEMBER 31, 2018 AND COMPARATIVE INFORMATION**

(Amounts expressed in thousands of Argentine Pesos, except as otherwise indicated)

- Leases to explore or use minerals, oil, natural gas and similar non-renewable resources;
- Leases of biological assets within the scope of IAS 41 "Agriculture" kept by a lessee;
- Contracts included in the scope of application of IFRIC 12 "Service Concession Agreements";
- Intellectual property licenses granted by a lessor within the scope of IFRS 15 "Revenue from contracts with customers"; and
- Rights enjoyed by a lessee under license agreements that are within the scope of IAS 38 "Intangible assets" for items such as movies, videos, games, manuscripts, patents and copyrights.

The model introduced by this standard is based on the definition of the term "lease", which is mainly related to the concept of control. IFRS 16 makes a difference between lease contracts and service contracts on the basis of whether an identified asset is under the customer's control, which is deemed to exist if the customer has the right to: i) substantially obtain all the economic benefits from the use of the asset; and ii) control the use of the asset.

Lessor's accounting:

IFRS 16 requires the lessor to classify the lease as operational or financial. A finance lease is a lease in which substantially all the risks and benefits derived from ownership of the asset are transferred. A lease will be classified as operating if it does not transfer substantially all the risks and benefits derived from the ownership of an underlying asset.

The classification of the lease is made on the effective date of the agreement and is evaluated again only if there is an amendment to the lease. Changes in estimates (e.g., changes in the economic life or in the residual value of the underlying asset) or changes in circumstances (e.g., non-compliance by the lessee) will not result in a new classification of the lease for accounting purposes.

Lessee's accounting:

The standard establishes that once the lease is identified, an entity should recognize the following items:

- Right-of-use asset, whose cost includes:
  - (a) the amount of the initial measurement of the lease liability (as described below);
  - (b) any rent paid to the lessor prior to the commencement date or on the same date, after discounting any incentive received for the lease;
  - (c) the initial direct costs incurred by the lessee; and
  - (d) an estimate of the costs to be incurred by the lessee in dismantling and eliminating the underlying asset, restoring the place where the underlying asset is located or restoring the underlying asset to the condition required by the terms and conditions of the lease, unless such costs are incurred at the time of making of the inventories. The lessee could incur certain obligations because of such costs either on the date of commencement of the term of the lease, or because of having used the underlying asset during a specified period.

Subsequently, the valuation of the right to use the assets will be based on the cost model or the revaluation model under IAS 16 "Property, Plant and Equipment" (recognizing therefore the amortization and impairment in the profit and loss account and, if applicable the revaluation model, revaluations in equity). However, the IFRS 16 requires that the right to use a leased property investment be valued at its fair value under the provisions set forth in IAS 40 "Investment properties" for the investment property it holds.

- Lease liability, measured at the present value of the lease payments that have not been paid on that date. Lease payments will be discounted using the interest rate implied in the lease, if that rate could be easily determined. If that rate cannot be easily determined, the lessee will use the incremental rate for the lessee's loans.

Lease liabilities must include the following items:

- (a) fixed payments (including essentially fixed payments), less any lease incentive receivable;
- (b) variable payments, which depend on an index or a rate, initially measured by using the index or rate (e.g., payments related to the consumer price index, prices related to a benchmark interest rate such as LIBOR, or payments that vary to reflect changes in market rental prices) on the effective date of the contract;
- (c) amounts that the lessee expects to pay as residual value guarantees;
- (d) the exercise price of a call option if the lessee is reasonably certain to exercise that option; and

**YPF ENERGÍA ELÉCTRICA SOCIEDAD ANÓNIMA**  
**NOTES TO THE CONSOLIDATED FINANCIAL STATEMENTS**  
**AS OF DECEMBER 31, 2018 AND COMPARATIVE INFORMATION**

(Amounts expressed in thousands of Argentine Pesos, except as otherwise indicated)

- (e) payment of penalties for terminating the lease, if the lease period reflects that the lessee will exercise an option to terminate it (i.e., because there is a reasonable certainty thereon).

Subsequently, the lessee will be increasing the liability for the lease to reflect the accrued interest (and recognized in the profit and loss account), deduct the installments that are being paid from such liability and recalculate the book value to reflect any review, amendment to the lease or review of the so-called "in-substance" installments.

The lessee must review the lease liability in the following cases:

- (a) when there is a change in the amount expected to be paid under a residual value guarantee;
- (b) when there is a change in future rental payments to reflect the variation of an index or an interest rate used to determine such rental payments (including, for example, a market rent review);
- (c) when there is a change in the term of duration of the lease as a result of a change in the non-cancellable period of the lease (for example, if the lessee does not exercise an option previously included in the determination of the lease period); or
- (d) when there is a change in the evaluation of the call option of the underlying asset.

Preliminary assessment

During fiscal year 2018, the Group has developed the IFRS 16 implementation project to evaluate the application effects of this standard, including the impacts on the consolidated financial statements, key performance indicators and financial metrics, as well as the development of accounting policies. Additionally, an evaluation of the necessary changes in the systems and processes has been carried out. For these purposes, the Group has reviewed substantially all of the group's leasing arrangements over the last year in light of the new lease accounting rules in IFRS 16.

Based on such analysis, it was preliminary concluded that the new definition of lease does not significantly change the scope of the contracts deemed as leases.

The Group expects to recognize in the balance sheet right-of-use assets and lease liabilities of about 206,005, on January 1, 2019, measured at the present value of future lease payments.

Regarding the comprehensive statement of income, the Group expects that the net fiscal year result will decrease by about 46,440 for fiscal year 2019, as a result of recognizing depreciations of right-of-use assets and the accrual of interest of lease liabilities.

On the other hand, as the repayment of the principal portion of lease liabilities will be classified as cash flows from financing activities, the Group expects a decrease thereof and that cash flows from operating activities will increase in about 19,320 for 2019.

The application of this standard will have no effect on the retained earnings since the Group intends to apply the simplified model without restating any comparative figures, recognizing a right-of-use asset equivalent to the lease liability on the initial date of transition (January 1, 2019). There are no adjustments to be made due to impairment arising from the provision for onerous contracts related to these right-of-use assets.

With regard to short-term leases, and leases of low-value assets, the Group intends to continue recognizing them as straight-line expense over the effective term of the lease, unless another systematic basis is more representative, in accordance with the option indicated by the standard.

Moreover, the Group intends to apply the practical solution of the standard whereby leases expiring within the term of 12 months from the date of the initial application, regardless of the original date, and which comply with the conditions to be classified as short term leases, follow the treatment described in the previous paragraph.

The group's activities as a lessor are not material and hence the Group does not expect any significant impact on the consolidated financial statements.

Additionally, see Note 2.3.18.

**2.6.2. Uncertainty about income tax treatment - IFRIC 23**

In June 2017, the IASB issued the interpretation IFRIC 23 - Uncertainty about income tax treatment. The interpretation clarifies the application of recognition and measurement requirements in IAS 12 "Income Tax" when there is uncertainty about the treatment of income tax. The interpretation specifically addresses the following: (a) if an entity considers uncertain tax treatments separately, (b) the assumptions of an entity made in the examination of tax treatments by the tax authorities, (c) how an entity determines the tax profit (or tax loss), tax bases, unused tax losses, unused tax credits and tax rates and (d)

**YPF ENERGÍA ELÉCTRICA SOCIEDAD ANÓNIMA**  
**NOTES TO THE CONSOLIDATED FINANCIAL STATEMENTS**  
**AS OF DECEMBER 31, 2018 AND COMPARATIVE INFORMATION**

(Amounts expressed in thousands of Argentine Pesos, except as otherwise indicated)

how an entity considers changes in facts and circumstances. IFRIC 23 is effective for annual periods beginning on or after January 1, 2019. Early adoption is permitted.

The Group estimates that the application of the aforementioned amendment will not have a significant effect on the financial statements of the Company.

**2.6.3. Amendments to IAS 28 - Long-term Investments in associates and joint ventures**

In October 2017, the IASB issued amendments to IAS 28, which are applicable to the fiscal years beginning on or after January 1, 2019, allowing early application.

The amendment defines that the long-term investments in associates and joint ventures, which are not accounted for using the equity method, will be accounted for in accordance with IFRS 9.

The Group estimates that the application of the aforementioned amendment will not have a significant effect on the financial statements of the Company.

**2.6.4. Amendments to IFRS 10 and IAS 28 – Sale or contribution of assets between an investor and its associate or joint venture**

In September 2014, the IASB amended IFRS 10 and IAS 28 to clarify that in transactions involving a controlled company, the extent of the gain or loss to be recognized in the financial statements depends on whether the sold or contributed controlled company is considered a business in accordance with IFRS 3.

On August 10, 2015, the IASB issued a proposal to postpone the effective date of these changes indefinitely depending on the outcome of its research project on accounting by the equity method, which was approved on December 17, 2015.

**2.6.5. Amendments to IAS 19 – Employee benefits**

In February 2018, the IASB issued amendments to this standard guidance, in relation to the accounting for the Plan amendment, curtailment and settlement.

An entity shall determine the cost of services for the current period and the net interest for the remainder of the annual period, using actuarial assumptions determined at the beginning of the annual reporting period. However, if an entity remeasures the liability (asset) for net defined benefits, it will determine the current cost of the service and the net interest for the remainder of the annual period, using actuarial assumptions updated after the plan change.

Another modification consists in recognizing in results any reduction in the surplus, even if that surplus was not previously recognized due to the impact of the asset ceiling.

The Group estimates that the application of this amendment, effective as of January 1, 2019, allowing early application, will not have any significant effects on its financial statements.

**2.6.6. Amendments to IFRS 3 – Business combinations**

In October 2018, the IASB has issued 'Definition of a Business (Amendments to IFRS 3)' aimed at resolving the difficulties that arise when an entity determines whether it has acquired a business or a group of assets. The amendments are effective for business combinations for which the acquisition date is on or after the beginning of the first annual reporting period beginning on or after 1 January 2020. Early application is allowed.

The amendments:

- clarify that to be considered a business, an acquired set of activities and assets must include, at least, an input and a substantive process that together significantly contribute to the ability to create outputs;
- remove the assessment of whether market participants are capable of replacing any missing inputs or processes and continuing to produce outputs;
- add guidance and illustrative examples to help entities assess whether a substantive process has been acquired;
- narrow the definitions of a business and of outputs by focusing on goods and services provided to customers and by removing the reference to an ability to reduce costs; and
- add an optional concentration test that permits a simplified assessment of whether an acquired set of activities and assets is not a business.

The Company has applied in advance the amendments to IFRS 3.

**YPF ENERGÍA ELÉCTRICA SOCIEDAD ANÓNIMA**  
**NOTES TO THE CONSOLIDATED FINANCIAL STATEMENTS**  
**AS OF DECEMBER 31, 2018 AND COMPARATIVE INFORMATION**

(Amounts expressed in thousands of Argentine Pesos, except as otherwise indicated)

**2.6.7. Amendments to IAS 1 “Presentation of financial statements” and IAS 8 “Accounting policies, changes in accounting estimates and errors” – Definition of material**

In October 2018, the IASB issued amendments that are applicable to fiscal years beginning on or from January 1, 2020, allowing for its anticipated application.

The amendments to the definitions of “material” or “with relative importance” seek to unify the definition of such concepts to the definitions of Conceptual Framework, also amended in 2018.

The Group estimates that the implementation of these amendments will not affect its financial statements.

**2.6.8. Amendments to References to the Conceptual Framework for Financial Reporting**

In March 2018, the IASB issued the revised Conceptual Framework applicable to annual periods beginning on or after January 1, 2020. This revision process did not imply a substantial change in the set of definitions, concepts and guidelines used as a basis for preparing financial information.

**2.6.9. Annual improvements to IFRS - 2015-2017 cycle**

In December 2017, the IASB issued the 2015-2017 cycle of annual improvements that are applicable for the years beginning on or after January 1, 2019.

A summary of the main modified standards and their purpose follows:

Standard	Amended Subject	Detail
IFRS 3 "Business Combinations" and IFRS 11 "Joint arrangements"	Holdings previously held in a joint operation	The amendment to IFRS 3 establishes that when obtaining control of a business that was a joint operation, the acquirer will apply the requirements for a business combination carried out in stages, including the remeasurement of its previously held share in the joint operation at the reasonable value on the acquisition date. On the other hand, the amendment to IFRS 11 establishes that when obtaining joint control of a business that was a joint operation, it does not measure again its previous holdings.
IAS 12 "Income Tax"	Exposure of the effect of dividends on Income Tax	The amendment clarifies that the entity will recognize the consequences of the dividends on the income tax where it has recognized the transactions or events that gave rise to those distributable profits.
IAS 23 "Loan Costs"	Capitalization of generic loans	The amendment to this standard clarifies that, for the capitalization of costs from generic loans, it must necessarily consider all outstanding loans when determining the capitalization rate, except those taken specifically to finance an eligible asset that is not yet ready for its intended use or sale; i.e., if any specific loan remains unpaid after the related eligible asset is ready for its intended use or for sale, that loan becomes part of the funds that the entity took as generic loans.

The Group does not anticipate that the application of the amendments to the mentioned standards will have a significant effect on its financial statements.

**YPF ENERGÍA ELÉCTRICA SOCIEDAD ANÓNIMA**  
**NOTES TO THE CONSOLIDATED FINANCIAL STATEMENTS**  
**AS OF DECEMBER 31, 2018 AND COMPARATIVE INFORMATION**

(Amounts expressed in thousands of Argentine Pesos, except as otherwise indicated)

### 3. ACQUISITIONS AND DISPOSITIONS

#### 3.a) Sale of interest in “Ramos Consortium” and CDS

On February 2, 2018, the Company transferred to YPF its share of 27% in Area Ramos Consortium in Salta province. The consideration payment was 40,143 and it was cancelled by YPF through the compensation of certain amounts that the Company owed to YPF under a loan agreement between the parties and other outstanding balances.

In addition, on March 1, 2018, the Company’s directors approved the sale of its direct share in CDS to YPF. The transferred share corresponds to 11,869,046,207 ordinary Class B shares, with a face value of 0.01 and one vote per share, representing 9.64% of the share capital and votes of CDS. The consideration paid by YPF amounted to 283,247.

The disposition of these interests was booked following the accounting criteria for transactions under common control, adjusting directly in equity the difference between the book value and the fair value of the consideration received.

#### 3.b) Acquisition of Y-GEN and Y-GEN II

On March 20, 2018, the Company acquired from GE a 33.33% ownership interest in Y-GEN and Y-GEN II. As a result, the Company achieved 100% interest and have taken control over such entities as from such date.

The acquisitions were recognized using the accounting criteria for business combinations achieved in stages as detailed in Note 2.3.21.

#### Consideration transferred

The fair value of the consideration transferred was to US\$ 80,208,965 (equivalent to 1,626,154 at the acquisition date).

#### Identifiable assets acquired and identifiable liabilities assumed

The following table summarizes the fair values recognized for assets acquired and liabilities assumed in connection with the acquisitions:

<u>Identifiable net assets acquired, net (at 100%)</u>	<u>Fair value</u>
Cash and cash equivalents	172,612
Investments in financial assets	50,154
Trade receivables and other receivables	1,446,928
Property, plant and equipment	8,664,782
Accounts payable	(349,557)
Loans	(4,176,661)
Net deferred income tax liabilities	(952,166)
Others	(5,214)
<b>Total</b>	<b>4,850,878</b>

Considering that the companies only prepare monthly financial information at the end of each month, the identifiable assets and liabilities as of March 31, 2018, have been taken into account. If the purchase price allocation would have been carried out as of March 20, 2018, it would not have differed significantly.

Given the nature of Y-GEN and Y-GEN II business and assets, the fair value of the assets acquired and the liabilities assumed was measured using the income approach, which using valuation techniques converts future amounts (such as cash flows or income and expenses) into a single current amount (that is, discounted). The fair value measurement reflects current market expectations for those future amounts.

#### Remeasurement of pre-existing interest

The remeasurement of the fair value of the Company’s pre-existing 66.67% equity interest in Y-GEN and Y-GEN II resulted in a gain from continued operations of 1,785,033. The gain recognized was the positive difference between the acquisition-date fair value of the pre-existing equity interest of 3,224,724, and the carrying amount of the investment accounted for using the equity method at the acquisition date of 1,439,691.

If the business combination had been made as of January 1, 2018, the Group’s revenues and the net profit for the year before income tax would have been 7,471,951 and 4,948,568, respectively.

**YPF ENERGÍA ELÉCTRICA SOCIEDAD ANÓNIMA**  
**NOTES TO THE CONSOLIDATED FINANCIAL STATEMENTS**  
**AS OF DECEMBER 31, 2018 AND COMPARATIVE INFORMATION**

(Amounts expressed in thousands of Argentine Pesos, except as otherwise indicated)

**3.c) Acquisition of Central La Plata Cogeneración**

On February 8, 2018, the acquisition of the La Plata Cogeneration plant was made by YPF EE to Central Puerto S.A. with effects as of January 5, 2018 (the acquisition date) in the amount of US\$ 31,500,000 (equivalent to 620,393 at the acquisition date) plus value added tax. The plant is located within the La Plata Industrial Complex and has a power generating capacity of 128 MW. Following our evaluation, it was concluded that as the assets acquired are concentrated in the co-generation power plant, the acquisition does not constitute a business (Note 2.6.6).

Since the acquisition date, La Plata cogeneration plant contributed with revenues of 832 million.

**3.d) Acquisition of Luz del Cerro S.A.**

On May 10, 2018, the Company acquired 100% of the shares of Luz del Cerro S.A., a company whose single asset is the development of the wind farm project known as "Parque Eólico Los Teros" (Los Teros Wind Farm) located in the town of Azul, Province of Buenos Aires. The wind farm will have a 122.5MW capacity. The purchase price of the shares amounted to 98,497 million.

The acquired asset is an intangible asset consisting of the acquired wind project, which comprises irrevocable option contracts for the constitution of usufructs in four plots of land in the town of Azul, province of Buenos Aires, where the Project is located, previous feasibility studies (electric, environmental, etc.) and permits, licenses and authorizations that are being processed corresponding to the Wind Farm.

**3.e) Acquisition of Luz del Valle S.A.**

On November 21, 2018, the Company acquired 100% of the shares of Luz del Valle S.A., a company whose single asset is the development of the wind farm project known as "Parque Eólico Los Teros II" (Los Teros II Wind Farm) located in the town of Azul, Province of Buenos Aires. The wind farm will have a 49.8MW capacity. The purchase price of the shares amounted to 44,888.

The acquired asset is an intangible asset consisting of the acquired wind project, which comprises irrevocable option contracts for the constitution of usufructs in a plot of land in the town of Azul, province of Buenos Aires, where the project is located, previous feasibility studies (electric, environmental, etc.) and permits, licenses and authorizations that are being processed corresponding to the Wind Farm.

All the dates included in this note, correspond to the dates of acquisitions and sale in accordance with the provisions of IFRS 3.

**4. FINANCIAL RISK MANAGEMENT**

The Group's activities involve various types of financial risks: market risk (including exchange rate risk, interest rate risk and price risk), credit risk and liquidity risk. The Group maintains an organizational structure and systems that allow the identification, measurement and control of the risks to which it is exposed.

**4.1. Market risk**

The market risk to which the Group is exposed is the possibility that the valuation of the Group's financial assets or financial liabilities as well as certain expected cash flows may be adversely affected by changes in interest rates, exchange rates or certain other price variables.

The following is a description of these risks as well as a detail of the extent to which the Group is exposed and a sensitivity analysis of possible changes in each of the relevant market variables.



**YPF ENERGÍA ELÉCTRICA SOCIEDAD ANÓNIMA**  
**NOTES TO THE CONSOLIDATED FINANCIAL STATEMENTS**  
**AS OF DECEMBER 31, 2018 AND COMPARATIVE INFORMATION**

(Amounts expressed in thousands of Argentine Pesos, except as otherwise indicated)

– **Exchange rate risk**

The value of financial assets and liabilities denominated in a currency different from the Group's functional currency is subject to variations resulting from fluctuations in exchange rates. Since YPF's functional currency is the U.S. dollar, the currency that generates the greatest exposure is the Argentine peso, the Argentine legal currency. The Group does not use derivatives as a hedge against exchange rate fluctuations.

Balances of financial assets and liabilities denominated in Argentine pesos, are as follows:

	<b>December 31, 2018</b>
Assets	2,421,605
Liabilities	<u>(5,169,566)</u>
Exchange rate exposure, net	<u><b>(2,747,961)</b></u>

*Exchange rate sensitivity*

The following table shows the sensitivity of the net income before tax, as of December 31, 2018, in face of a devaluation of the Argentine peso with respect to its functional currency, considering that all other variables will remain constant (due to changes in the fair value of the monetary assets and liabilities).

<b>Depreciation (-) / Appreciation (+) of exchange rate of Argentine peso against U.S. dollar</b>	<b>Net Income before tax, for the year ended December 31, 2018 (losses) / Gains</b>
+10%	(274,796)
-10%	274,796

– **Interest rate risk**

The Group is exposed to risks associated with fluctuations in interest rates on loans and investments. Changes in interest rates may affect the interest income or expenses derived from financial assets and liabilities tied to a variable interest rate. Additionally, the fair value of financial assets and liabilities that accrue interests based on fixed interest rates may also be affected.

The table below provides information about the financial liabilities as of December 31, 2018, that accrues interest considering the applicable rate:

	<b><u>Financial Liabilities <sup>(1)</sup></u></b>
Fixed interest rate	5,502,366
Variable interest rate	<u>19,268,612</u>
<b>Total <sup>(2)</sup></b>	<u><b>24,770,978</b></u>

(1) Includes only financial loans. Does not include accounts payable, which mostly do not accrue interest.

(2) Includes principal and interest.

The fixed and variable rate financial loans represent 22% and 78%, respectively, of the total loans as of December 31, 2018, and include, financial loans with local and international entities. The portion of the loan, which accrues variable interest rate, is mainly exposed to the fluctuations in LIBOR.

Financial assets mainly include, in addition to trade receivables, which have low exposure to interest rate risk, bank deposits, fixed-interest deposits and investments in mutual funds such as "money market" or short-term fixed interest rate instruments.

The Group's strategy to hedge interest rate risk is based on placing funds at a variable interest rate, which partially offset financial loans at a variable interest rate, as well as using cash flow hedging .

In June 2017, Y-GEN and Y-GEN II entered into a five years interest rate swap contract with Citibank N.A., London Branch to hedge its variable interest rate cash flows, with approximately US\$ 156,000,000 declining notional amount (see Note 13). The Group receives a variable interest rate and pays a fixed rate of interest of 1.947% for approximately loan's 75% .

The table below shows the estimated impact on the consolidated net income (loss) before tax of an increase or decrease of 100 basis points in the interest rate.

**YPF ENERGÍA ELÉCTRICA SOCIEDAD ANÓNIMA**  
**NOTES TO THE CONSOLIDATED FINANCIAL STATEMENTS**  
**AS OF DECEMBER 31, 2018 AND COMPARATIVE INFORMATION**

(Amounts expressed in thousands of Argentine Pesos, except as otherwise indicated)

	<u>Increase (+) / decrease (-) in the interest rates (basis points)</u>	<u>Income (loss) for the year ended December 31, 2018</u>
Impact on net income (loss) before tax	+100 -100	(137,687) 137,687

– **Price risk**

The Group is not exposed to price risks due to our sales under Resolution SEE No.19/2017 are made at fixed prices in U.S. dollars, converted to Argentine pesos and the PPA signed with CAMMESA, YPF and others related parties, also made at fixed prices in US dollar provides stability in operating cash flows.

**4.2 Liquidity risk**

Liquidity risk is associated with the possibility of a mismatch between the need of funds to meet short, medium or long-term obligations.

As mentioned in previous paragraphs, the Group intends to align the maturity profile of its financial debt to be related to its ability to generate enough cash flows for its cancellation, as well as to finance the projected expenditures for each year. As of December 31, 2018, the cash and cash equivalents reached 6,190 million, considering cash and cash equivalents of 4,701 and other financial assets for 1,489 million.

The following table sets forth the maturity dates of the Group's financial liabilities as of December 31, 2018:

<u>As of December 31, 2018</u>	<u>Less than 3 month</u>	<u>3 to 12 months</u>	<u>1 to 5 years</u>	<u>More than 5 years</u>	<u>Total</u>
Loans	1,548,364	4,966,044	17,007,680	1,248,890	24,770,978
Accounts payable and other liabilities	4,565,529	99,359	-	-	4,664,888
	<u>6,113,893</u>	<u>5,065,403</u>	<u>17,007,680</u>	<u>1,248,890</u>	<u>29,435,866</u>

Most of the Group's loans contain usual clauses of financial commitments (covenants) associated with leverage ratio and debt coverage ratio. See Note 13.

Under the terms of the loan agreements, if the Group breached a covenant or if it could not remedy it within the stipulated period, it would default, a situation that would limit its liquidity and, given that the majority of its loans contain cross default provisions, it could result in an early enforceability of its obligations.

**4.3 Credit risk**

Credit risk is defined as the possibility of a third party not complying with its contractual obligations, thus negatively affecting results of operations of the Group.

Credit risk in the Group is measured and controlled on an individual customer basis. The Group has its own systems to conduct a permanent evaluation of credit performance of all of its debtors, and the determination of risk limits with respect to third parties, in line with best practices using for such end internal customer records and external data sources.

Financial instruments that potentially expose the Group to a credit concentration risk consist primarily of cash and cash equivalents, trade receivables and other receivables. The Group invests excess cash primarily in high liquid investments with financial institutions with a strong credit rating both in Argentina and abroad. In the normal course of business and based on ongoing credit evaluations to its customers, the Group provides credit to its customers and certain related parties. Likewise, the Group accounts for doubtful trade losses in the Statement of Comprehensive Income, based on specific information regarding its clients.

The provisions for doubtful accounts are measured by the criteria expressed in Note 2.3.9.1.

The maximum exposure to credit risk of the Group of December 31, 2018, based on the type of its financial instruments and without excluding the amounts covered by guarantees and other arrangements mentioned below is set forth below:

**YPF ENERGÍA ELÉCTRICA SOCIEDAD ANÓNIMA**  
**NOTES TO THE CONSOLIDATED FINANCIAL STATEMENTS**  
**AS OF DECEMBER 31, 2018 AND COMPARATIVE INFORMATION**

(Amounts expressed in thousands of Argentine Pesos, except as otherwise indicated)

	<u>Maximum exposure as of December 31, 2018</u>
Cash and cash equivalents	4,701,336
Trade receivables	3,724,234
Other receivables	8,080,431
Other financial assets	1,489,031
Investment in financial assets	69,901
	<u><b>18,064,933</b></u>

Considering the maximum exposure to the risk, trade receivables and other receivables related to CAMMESA accounts for approximately 20% of these receivables.

Financial assets past due as of December 31, 2018 are not material.

At such date, the provision for doubtful other receivables is not significant and includes certain tax credits.

## 5. FINANCIAL INSTRUMENTS BY CATEGORY

The following tables show the financial assets and liabilities by category of financial instrument and a reconciliation with the corresponding accounts in the financial statement, as appropriate. Since the accounts "Trade receivables", "Other receivables", "Trade payables" and "Other liabilities" contain financial instruments, as well as non-financial assets and liabilities (such as taxes and advances to property, plant and equipment), the reconciliation is shown within the "Non-financial assets" and "Non-financial liabilities" columns.

### Financial Assets

	<u>12.31.2018</u>			
	<u>Financial Assets at amortized cost</u>	<u>Financial Assets at fair value through comprehensive income</u>	<u>Non-financial Assets</u>	<u>Total</u>
Other receivables	5,861,037	-	2,219,394	8,080,431
Other financial assets (See Note 13)	1,489,031	-	-	1,489,031
Investment in financial assets	-	69,901	-	69,901
Trade receivables	3,724,234	-	-	3,724,234
Cash and cash equivalents	4,701,336	-	-	4,701,336
	<u><b>15,775,638</b></u>	<u><b>69,901</b></u>	<u><b>2,219,394</b></u>	<u><b>18,064,933</b></u>

	<u>12.31.2017</u>			
	<u>Financial Assets at amortized cost</u>	<u>Financial Assets at fair value through profit or loss</u>	<u>Non-financial Assets</u>	<u>Total</u>
Other receivables	621,782	-	257,284	879,066
Trade receivables	707,855	-	-	707,855
Cash and cash equivalents	60,854	78,228	-	139,082
	<u><b>1,390,491</b></u>	<u><b>78,228</b></u>	<u><b>257,284</b></u>	<u><b>1,726,003</b></u>

	<u>01.01.2017</u>			
	<u>Financial Assets at amortized cost</u>	<u>Financial Assets at fair value through profit or loss</u>	<u>Non-financial Assets</u>	<u>Total</u>
Other receivables	708,773	-	306,538	1,015,311
Trade receivables	372,205	-	-	372,205
Cash and cash equivalents	633,067	18,380	-	651,447
	<u><b>1,714,045</b></u>	<u><b>18,380</b></u>	<u><b>306,538</b></u>	<u><b>2,038,963</b></u>

**YPF ENERGÍA ELÉCTRICA SOCIEDAD ANÓNIMA**  
**NOTES TO THE CONSOLIDATED FINANCIAL STATEMENTS**  
**AS OF DECEMBER 31, 2018 AND COMPARATIVE INFORMATION**

(Amounts expressed in thousands of Argentine Pesos, except as otherwise indicated)

**Financial Liabilities**

12.31.2018		
	Financial Liabilities at amortized cost	Total
Loans	24,770,978	24,770,978
Other liabilities	99,359	99,359
Accounts payable	4,565,529	4,565,529
	<b>29,435,866</b>	<b>29,435,866</b>

12.31.2017		
	Financial Liabilities at amortized cost	Total
Loans	4,080,979	4,080,979
Other liabilities	200	200
Accounts payable	879,428	879,428
	<b>4,960,607</b>	<b>4,960,607</b>

01.01.2017		
	Financial Liabilities at amortized cost	Total
Loans	1,688,545	1,688,545
Other liabilities	200	200
Accounts payable	639,388	639,388
	<b>2,328,133</b>	<b>2,328,133</b>

Gains and losses on financial instruments are allocated to the following categories:

12.31.2018				
	Financial Assets / Liabilities at amortized cost	Financial Assets at fair value through profit or loss	Non-financial Assets / Liabilities	Total
Interest income and other	97,570	103,301	-	200,871
Interest loss	(606,025)	-	-	(606,025)
Net exchange differences	(358,713)	(313,394)	(245,261)	(917,368)
	<b>(867,168)</b>	<b>(210,093)</b>	<b>(245,261)</b>	<b>(1,322,522)</b>

12.31.2017				
	Financial Assets / Liabilities at amortized cost	Financial Assets at fair value through profit or loss	Non-financial Assets / Liabilities	Total
Interest income and other	86,915	42,056	-	128,971
Interest loss	(78,185)	-	-	(78,185)
Net exchange differences	(49,076)	(6,487)	16,356	(39,207)
	<b>(40,346)</b>	<b>35,569</b>	<b>16,356</b>	<b>11,579</b>

**6. QUANTITATIVE AND QUALITATIVE INFORMATION ON FAIR VALUES**

**6.1. Information on the fair value of financial assets and liabilities by category**

The book values of the financial assets and liabilities at amortized cost identified in note 5 do not significantly differ from their fair values as of December 31, 2018, December 31, 2017, and January 1, 2017.

**6.2. Valuation techniques**

The fair value reported in connection with the abovementioned financial assets and liabilities is the amount at which the instrument could be exchanged in a current transaction between willing parties, other than in a forced or liquidation sale. The following methods and assumptions were used to estimate the fair values:

- Management assessed that the fair values of current trade receivables, other financial assets and other current receivables and accounts payable, other liabilities and variable rate loans, approximates the carrying amounts mainly due to the short-term maturities of these instruments and to the fact that the loans mainly have variable interest rates.
- Fair value of fixed rate loans is calculated by the appropriated valuation technics that use observable market data.
- Fair value of mutual funds is based on price quotations as of the end of each year .

**YPF ENERGÍA ELÉCTRICA SOCIEDAD ANÓNIMA**  
**NOTES TO THE CONSOLIDATED FINANCIAL STATEMENTS**  
**AS OF DECEMBER 31, 2018 AND COMPARATIVE INFORMATION**

(Amounts expressed in thousands of Argentine Pesos, except as otherwise indicated)

- Fair value of the investments in financial assets (hedge instruments) is calculated using appropriate valuation techniques that don't use observable market data. The valuation model estimates the present value of the swap through a forecast of the flow of certain and estimated future funds using a forward rate curve and discounting those future cash flows using a discount rate curve. The forward rate curve is built from information available and published in the market for specific terms and currencies, using in turn the interpolation methodology for years in which there is no information available in the market in order to obtain a continuous curve.

### 6.3. Fair value hierarchy

#### 6.3.1. Assets at fair value

As of December 31, 2018, December 31, 2017, and January 1, 2017, the Group maintained the following financial assets measured at fair value in its consolidated statement of financial position:

	12.31.2018		12.31.2017		01.01.2017	
	Level 1	Level 3	Level 1	Level 3	Level 1	Level 3
Mutual funds	-	-	78,228	-	18,380	-
Hedging instruments	-	69,901	-	-	-	-
	-	<b>69,901</b>	<b>78,228</b>	-	<b>18,380</b>	-

There have been no transfers of financial assets between different fair value hierarchies during the year ended December 31, 2018 and 2017.

#### 6.3.2. Conciliation of measures at fair value of Level 3

The following is an evolution of the financial assets measured at fair value:

	12.31.2018	12.31.2017
Amount at the beginning of the year	-	-
From a business combination (Note 3.b)	50,154	-
Change in fair value	19,747	-
<b>Amount at the end of the year</b>	<b>69,901</b>	-

**YPF ENERGÍA ELÉCTRICA SOCIEDAD ANÓNIMA**  
**NOTES TO THE CONSOLIDATED FINANCIAL STATEMENTS**  
**AS OF DECEMBER 31, 2018 AND COMPARATIVE INFORMATION**

(Amounts expressed in thousands of Argentine Pesos, except as otherwise indicated)

**7. PROPERTY, PLANT AND EQUIPMENT**

	Land and buildings	Mineral property, wells and related equipment (3)	Production facilities, machinery, equipment and spare parts of power plants	Transportation equipment	Materials and equipment in warehouse	Work in progress	Furniture, fixtures, computer and communication equipment	Total
<b>Cost or deemed cost:</b>								
<b>At January 1, 2017</b>	<b>5,796</b>	<b>316,310</b>	<b>1,479,592</b>	<b>4,814</b>	<b>112,419</b>	<b>1,512,563</b>	<b>4,920</b>	<b>3,436,414</b>
Additions (2)	-	10,662	174,864	4,544	100,335	2,445,162	144	2,735,711
Decreases	-	(9)	(4)	(132)	(37,053)	(377)	-	(37,575)
Transfers	21,861	13,374	2,026,671	-	-	(2,066,269)	4,363	-
Translation effect	1,010	55,139	369,940	1,220	29,391	497,136	868	954,704
<b>At December 31, 2017</b>	<b>28,667</b>	<b>395,476</b>	<b>4,051,063</b>	<b>10,446</b>	<b>205,092</b>	<b>2,388,215</b>	<b>10,295</b>	<b>7,089,254</b>
Business Combination (Note 3.b)	-	-	708,481	8,090	736,145	8,410,746	14,548	9,878,010
Disposals	(764)	(388,059)	8,664,782	(1,662)	(49,572)	(19,316)	(1,350)	8,664,782
Transfers	220	2,583	8,219,391	-	-	(8,222,194)	-	-
Translation effect	30,011	-	11,777,620	9,601	321,773	4,972,124	-	17,120,634
<b>At December 31, 2018</b>	<b>58,134</b>	<b>-</b>	<b>33,421,337</b>	<b>26,475</b>	<b>1,213,438</b>	<b>7,529,575</b>	<b>32,998</b>	<b>42,281,957</b>
<b>Depreciation and impairment</b>								
<b>At January 1, 2017</b>	<b>2,502</b>	<b>274,876</b>	<b>1,210,532</b>	<b>2,885</b>	<b>-</b>	<b>-</b>	<b>4,561</b>	<b>1,495,356</b>
Depreciation for the year	678	12,262 (1)	74,223	1,152	-	-	500	88,815
Decreases	-	-	-	(125)	-	-	-	(125)
Transfers	-	-	-	-	-	-	-	-
Translation effect	521	49,438	218,583	786	-	-	857	270,485
<b>At December 31, 2017</b>	<b>3,701</b>	<b>336,576</b>	<b>1,503,638</b>	<b>4,698</b>	<b>-</b>	<b>-</b>	<b>5,918</b>	<b>1,854,531</b>
Depreciation for the year	1,054	3,407	1,275,173	2,424	-	-	1,216	1,283,274
Decreases	(636)	(339,983)	-	(1,320)	-	-	(664)	(342,603)
Translation effect	3,474	-	1,822,951	4,219	-	-	5,646	1,836,290
<b>At December 31, 2018</b>	<b>7,593</b>	<b>-</b>	<b>4,601,762</b>	<b>10,021</b>	<b>-</b>	<b>-</b>	<b>12,116</b>	<b>4,631,492</b>
<b>Net book value</b>								
<b>At December 31, 2018</b>	<b>50,541</b>	<b>-</b>	<b>28,819,575</b>	<b>16,454</b>	<b>1,213,438</b>	<b>7,529,575</b>	<b>20,882</b>	<b>37,650,465</b>
<b>At December 31, 2017</b>	<b>24,966</b>	<b>58,900</b>	<b>2,547,425</b>	<b>5,748</b>	<b>205,092</b>	<b>2,388,215</b>	<b>4,377</b>	<b>5,234,723</b>
<b>At January 1, 2017</b>	<b>3,294</b>	<b>41,434</b>	<b>269,060</b>	<b>1,929</b>	<b>112,419</b>	<b>1,512,563</b>	<b>359</b>	<b>1,941,058</b>

(1) Depreciation has been calculated using the unit-of-production method (Note 2.3.7.2). Corresponds to discontinued operations.

(2) Includes 517,606 and 151,896 of financial cost related to financing from third parties for extended works in progress for years ended December 31, 2018 and 2017, respectively.

(3) Discontinued operation (See Note 3.a).

**YPF ENERGÍA ELÉCTRICA SOCIEDAD ANÓNIMA**  
**NOTES TO THE CONSOLIDATED FINANCIAL STATEMENTS**  
**AS OF DECEMBER 31, 2018 AND COMPARATIVE INFORMATION**

(Amounts expressed in thousands of Argentine Pesos, except as otherwise indicated)

**8. INVESTMENT IN ASSOCIATES AND JOINT VENTURES**

The following table shows the value of the investments in associates and joint ventures at an aggregate level, as of December 31, 2018, December 31, 2017, and January 1, 2017:

	<u>12.31.2018</u>	<u>12.31.2017</u>	<u>01.01.2017</u>
Amount of investments in associates and joint ventures	1,948,492	2,424,677	459,326
<b>Total</b>	<b><u>1,948,492</u></b>	<b><u>2,424,677</u></b>	<b><u>459,326</u></b>

The main movements during the year ended December 31, 2018 and 2017, which affected the value of the aforementioned investments, correspond to:

	<u>12.31.2018</u>	<u>12.31.2017</u>
Amount at the beginning of year	2,424,677	459,326
Income on investments in associates	292,825	67,503
Decrease due to acquisition of control (Note 3.b))	(1,439,691)	-
Dispositions/Acquisitions	(305,648)	777,034
Dividends distribution	(53,996)	-
Exposed in Accounts payable	102	-
Shareholders' contributions	4,076	828,144
Translation differences	1,026,147	292,670
<b>Amount at the end of the year</b>	<b><u>1,948,492</u></b>	<b><u>2,424,677</u></b>

The following table shows the principal amounts of the results of the investments in associates and joint ventures of the Group, calculated according to the equity method therein, for the years ended December 31, 2018 and 2017. The Group has adjusted, if applicable, the figures reported by these companies to adapt them to the accounting principles used by the Group for the calculation of the equity method as of such dates:

	<u>Associates and joint ventures</u>	
	<u>12.31.2018</u>	<u>12.31.2017</u>
Net income for the year	268,015	67,503
Other comprehensive income for the year	24,810	-
<b>Comprehensive income for the year</b>	<b><u>292,825</u></b>	<b><u>67,503</u></b>

**Inversora Dock Sud S.A.**

The following table presents summary financial information for investments in IDS as of December 31, 2018, and 2017:

	<u>12.31.2018</u>	<u>12.31.2017</u>
Current assets	15,901	14,781
Non-current assets	4,529,672	1,951,122
Current liabilities	162	35,270
<b>Shareholders' equity</b>	<b><u>4,545,411</u></b>	<b><u>1,930,633</u></b>
<b>Investment book value</b>	<b><u>1,948,163</u></b>	<b><u>827,469</u></b>
	<u>12.31.2018</u>	<u>12.31.2017</u>
<b>Net income for the year <sup>(1)</sup></b>	<b><u>622,397</u></b>	<b><u>309,266</u></b>
<b>Share interest in net income of joint ventures</b>	<b><u>266,759</u></b>	<b><u>132,551</u></b>

(1) Investment acquired in May 2017.

**YPF ENERGÍA ELÉCTRICA SOCIEDAD ANÓNIMA**  
**NOTES TO THE CONSOLIDATED FINANCIAL STATEMENTS**  
**AS OF DECEMBER 31, 2018 AND COMPARATIVE INFORMATION**

(Amounts expressed in thousands of Argentine Pesos, except as otherwise indicated)

The following table shows information of investment in subsidiaries and joint ventures as of December 31, 2018, December 31, 2017 and January 1, 2017:

Name and issuer	12.31.2018				12.31.2017	01.01.2017
	Class	Face value	Amount	Book value	Cost	Book value
<b>Investments under common control:</b>						
Central Dock Sud S.A. <sup>(2)</sup>	Common	-	-	-	-	276,263
Inversora Dock Sud S.A.	Common	1	355,270,372	1,948,163	538,065	827,469
<b>Subsidiaries:</b>						
YPF - EE Comercializadora S.A.U. <sup>(3)</sup>	Common	1	86,000	-	100	100
Y-GEN Eléctrica S.A.U. <sup>(1)</sup>	Common		-	-	-	389,946
Y-GEN Eléctrica II S.A.U. <sup>(1)</sup>	Common		-	-	-	930,765
<b>Other companies:</b>						
Others <sup>(4)</sup>				329	329	134
				<b>1,948,492</b>	<b>538,494</b>	<b>2,424,677</b>
						<b>459,326</b>

Name and issuer	Registered address	Main business	Information of the issuers				Holding in capital stock
			Date	Capital stock	Net profit / (loss)	Shareholders' equity	
<b>Investments under common control</b>							
Inversora Dock Sud S.A.	San Martín 140, P.2º, Buenos Aires.	Financial and investment operations.	12.31.2018	828,942	944,223	5,426,786	42.86%
<b>Subsidiaries:</b>							
YPF - EE Comercializadora S.A.U	Av. Córdoba 111, CABA	Wholesale purchase and sale of electric power and energy	12.31.2017	86	(145)	(102) <sup>(3)</sup>	100.00%
Y-GEN Eléctrica S.A.U. <sup>(1)</sup>	Av. Córdoba 111, CABA	Generation, transport and commercialization of electricity.	12.31.2018	70,253	220,340	1,413,165	100.00%
Y-GEN Eléctrica II S.A.U. <sup>(1)</sup>	Av. Córdoba 111, CABA	Generation, transport and commercialization of electricity.	12.31.2018	603,766	589,672	7,340,736	100.00%

(1) As of December 31, 2018, 100% of the shares in these companies are owned by YPF EE, whereas of December 31, 2017, 66.67% of the shares were owned by YPF EE and the remaining 33.33% by GE Capital Global energy Investment B.V. of the GE Group.

(2) See Note 3.a).

(3) The negative amount of (102) calculated under equity method is disclosed in Accounts payable.

(4) Includes Y-GEN Eléctrica III S.R.L., Y-GEN Eléctrica IV S.R.L., Y-Luz Inversora S.A.U. and Luz del León S.A.



**YPF ENERGÍA ELÉCTRICA SOCIEDAD ANÓNIMA**  
**NOTES TO THE CONSOLIDATED FINANCIAL STATEMENTS**  
**AS OF DECEMBER 31, 2018 AND COMPARATIVE INFORMATION**

(Amounts expressed in thousands of Argentine Pesos, except as otherwise indicated)

**9. OTHER RECEIVABLES**

	<b>12.31.2018</b>	<b>12.31.2017</b>	<b>01.01.2017</b>
<b>Non-current:</b>			
Loans and advances to employees	-	347	183
Advances to suppliers to property, plant and equipment	1,231,559	170,410	288,671
Minimum presumed income tax	161,687	-	-
Related parties (Note 26)	452,881	452,881	513,854
	<b>1,846,127</b>	<b>623,638</b>	<b>802,708</b>
<b>Current:</b>			
Tax credits	736,536	72,797	6,716
Advances to suppliers	4,179	16,456	10,752
Loans and advances to employees	6,309	5,245	3,223
Trust	27,116	-	-
Related parties (Note 26)	5,374,731	158,675	138,988
Ramos Consortium	-	4,634	3,714
Prepaid insurance	5,526	-	-
Recovery of insurance claims receivables	-	-	48,811
Prepaid expenses	71,490	-	-
Miscellaneous	11,473	677	3,455
	<b>6,237,360</b>	<b>258,484</b>	<b>215,659</b>
Provision for doubtful receivables	(3,056)	(3,056)	(3,056)
	<b>6,234,304</b>	<b>255,428</b>	<b>212,603</b>

**10. TRADE RECEIVABLES**

	<b>12.31.2018</b>	<b>12.31.2017</b>	<b>01.01.2017</b>
<b>Current:</b>			
Trade receivables	71,305	174,360	41,046
Related parties (Note 26)	3,652,929	533,495	331,159
	<b>3,724,234</b>	<b>707,855</b>	<b>372,205</b>

**11. CASH AND CASH EQUIVALENTS**

For the purpose of the consolidated statement of financial position and the consolidated statement of cash flow, cash and cash equivalents comprise the following items:

	<b>12.31.2018</b>	<b>12.31.2017</b>	<b>01.01.2017</b>
<b>Cash and cash equivalents</b>			
Mutual funds	-	78,228	18,380
Fixed interest deposits	4,209,240	-	-
Cash and banks	492,096	60,854	633,067
	<b>4,701,336</b>	<b>139,082</b>	<b>651,447</b>

Bank balances accrue interest at variable rates based on the bank deposits daily rates. Short-term deposits are made for varying periods of between one day and three months, depending on the immediate cash needs of the Group and bear interest at the respective fixed rates for short-term deposits.

**YPF ENERGÍA ELÉCTRICA SOCIEDAD ANÓNIMA**  
**NOTES TO THE CONSOLIDATED FINANCIAL STATEMENTS**  
**AS OF DECEMBER 31, 2018 AND COMPARATIVE INFORMATION**

(Amounts expressed in thousands of Argentine Pesos, except as otherwise indicated)

**12. INCOME TAX**

The calculation of the income tax expense for the years ended December 31, 2018 and 2017 is as follows:

	<b>For the year ended December 31,</b>	
	<b>2018</b>	<b>2017</b>
Current income tax	-	(176,577)
Special tax – tax revaluation under Law No. 27,430 (see Note 25)	(130,809)	-
Deferred income tax	(288,256)	(189,402)
<b>Income Tax</b>	<b>(419,065)</b>	<b>(365,979)</b>

	<b>For the year ended December 31,</b>	
	<b>2018</b>	<b>2017</b>
Income tax from continued operations	(416,984)	(269,105)
Income tax from discontinued operations (Note 18)	(2,081)	(96,874)
<b>Income Tax</b>	<b>(419,065)</b>	<b>(365,979)</b>

The reconciliation between the charge to income tax expense for the years ended December 31, 2018 and 2017 and the one that would result from applying the prevailing tax rate on income before income tax arising from the consolidated statements of comprehensive income for those years is as follows:

	<b>12.31.2018</b>	<b>12.31.2017</b>
Income before income tax from continued operations	4,909,100	921,875
Income before income tax from discontinued operations (Note 18)	15,377	290,861
<b>Profit for the year before income tax</b>	<b>4,924,477</b>	<b>1,212,736</b>
Statutory tax rate	30%	35%
At statutory tax rate	(1,477,343)	(424,458)
Effect by change of tax rate <sup>(1)</sup>	(152,965)	74,253
Income on investments in associates	80,405	23,626
Remeasure of pre-existing equity interest	535,510	-
Exchange differences	2,263,780	176,206
Effects of the valuation of non-monetary assets in its functional currency	(1,478,889)	(180,912)
Special tax – tax revaluation under Law No. 27,430 (see Note 25)	(130,809)	-
Other	(58,754)	(34,694)
<b>Income tax for the year</b>	<b>(419,065)</b>	<b>(365,979)</b>

(1) Effect of applying the changes in the enacted tax rate established by Law No. 27,430 as described in Note 25 to the deferred assets and liabilities, according to its expected term of realization and settlement, respectively.

**Deferred income tax**

Breakdown of deferred income tax is as follows:

	<b>Consolidated statement of financial position</b>		
	<b>12.31.2018</b>	<b>12.31.2017</b>	<b>01.01.2017</b>
<b>Deferred tax assets</b>			
Provisions for doubtful receivables	764	764	1,070
Asset retirement obligation	-	27,222	25,114
Tax Losses carryforward	1,465,492	-	-
Miscellaneous	9,386	531	296
<b>Total deferred tax assets</b>	<b>1,475,642</b>	<b>28,517</b>	<b>26,480</b>
<b>Deferred tax liabilities</b>			
Receivables from deferred income	(43,412)	(52,033)	(68,098)
Property, plant and equipment	(3,790,713)	(323,772)	(116,268)
Subsidiaries hedging instruments	(17,987)	-	-
<b>Total deferred tax liabilities</b>	<b>(3,852,112)</b>	<b>(375,805)</b>	<b>(184,366)</b>
<b>Total net deferred tax</b>	<b>(2,376,470)</b>	<b>(347,288)</b>	<b>(157,886)</b>

**YPF ENERGÍA ELÉCTRICA SOCIEDAD ANÓNIMA**  
**NOTES TO THE CONSOLIDATED FINANCIAL STATEMENTS**  
**AS OF DECEMBER 31, 2018 AND COMPARATIVE INFORMATION**

(Amounts expressed in thousands of Argentine Pesos, except as otherwise indicated)

As of December 31, 2018, the Group recorded deferred assets of 54,153 and deferred liabilities of 2,430,623. As of December 31, and January 1, 2017, the Group recorded net deferred liabilities of 347,288 and 157,886, respectively.

Deferred tax assets and liabilities are disclosed net when: a) a legal right to compensate asset and liabilities exists and; b) when tax assets and liabilities are against the same tax authority.

As of December 31, 2018, the Group estimated a tax loss carryforward of 1,465,492 at the tax rate. Deferred income tax assets are recognized for tax loss carryforwards to the extent their set off through future taxable profits is probable. Tax loss carryforwards in Argentina expire within 5 years.

In order to fully realize the deferred income tax asset, the Group will need to generate taxable income. Based upon the level of historical taxable income and projections for future over the years in which the deferred income tax are deductible, Management of the Company believes that as of December 31, 2018 it is probable that the Group will realize all of the deferred income tax assets.

As of December 31, 2018, Group's tax loss carryforwards at the expected recovery rate were as follows:

<u>Date of generation</u>	<u>Date of expiration</u>	<u>Amount</u>
2016	2021	7,183
2017	2022	226,721
2018	2023	1,231,588
		<u><u>1,465,492</u></u>

As described in Note 2.3.6.1 to these financial statements, as of December 31, 2018 YPF Energía Eléctrica recorded a tax loss carry-forward and a gain accounting net income. Therefore, it has recognized a credit for the Minimum Presumed Income Tax of 161,687.

The evolution of net deferred tax as of December 31, 2018 and 2017 is as follows:

	<u>12.31.2018</u>	<u>12.31.2017</u>
<b>Amount at the beginning of year</b>	<b>(347,288)</b>	<b>(157,886)</b>
Other Comprehensive Income	(5,047)	-
Business combination (Note 3.b)	(952,166)	-
Conversion effect on business combination assets	(783,713)	-
Charge to net income of the year	(288,256)	(189,402)
<b>Amount at the end of the year</b>	<b>(2,376,470)</b>	<b>(347,288)</b>

### 13. LOANS

	<u>Interest rate <sup>(2)</sup></u>	<u>12.31.2018</u>		<u>12.31.2017</u>		<u>01.01.2017</u>	
		<u>Current</u>	<u>Non-current</u>	<u>Current</u>	<u>Non-current</u>	<u>Current</u>	<u>Non-current</u>
Loans with third parties	4.1856% - 9.297%	6,463,984	18,096,828	27,325	2,984,497	1,742	939,880
Loans with related parties (Note 26)	8.35%	-	-	942,293	-	7,243	739,680
Financial leases	(1)	50,424	159,742	22,757	104,107	-	-
		<u><u>6,514,408</u></u>	<u><u>18,256,570</u></u>	<u><u>992,375</u></u>	<u><u>3,088,604</u></u>	<u><u>8,985</u></u>	<u><u>1,679,560</u></u>

(1) See Note 23.j).

(2) Applicable rate as of December 31, 2018.

**YPF ENERGÍA ELÉCTRICA SOCIEDAD ANÓNIMA**  
**NOTES TO THE CONSOLIDATED FINANCIAL STATEMENTS**  
**AS OF DECEMBER 31, 2018 AND COMPARATIVE INFORMATION**

(Amounts expressed in thousands of Argentine Pesos, except as otherwise indicated)

The breakdown of the Group's borrowings as the years ended on December 31, 2018 and 2017 is as follows:

	<u>12.31.2018</u>	<u>12.31.2017</u>
<b>Balance at beginning of the year</b>	4,080,979	1,688,545
Proceed from loans	9,877,729	2,065,429
Payments of loans	(2,355,833)	(366,489)
Payments of interest	(949,923)	(176,737)
Accrued interest	1,114,414	215,356
Non – cash transactions	(352,971)	124,114
Incorporation by business combinations	4,176,661	-
Translation differences	9,179,922	530,761
<b>Balance at the end of the year</b>	<u><b>24,770,978</b></u>	<u><b>4,080,979</b></u>

The "Non-cash transactions" column includes the loans capitalization with YPF and the offsetting effect of the loan with YPF related to disposal of the interest in the Ramos Consortium. The group classifies interest paid as cash flows from financing activities.

### Main loans of the Group

#### - Program for the Issuance of Negotiable Obligations

On March 16, 2018, the Shareholders' Meeting approved the general terms and conditions of the Program (the "Program") for the issuance of Simple Negotiable Obligations (not convertible into shares) in accordance with the Negotiable Obligations Law (Ley de Obligaciones Negociables) as amended, for an aggregate nominal value of up to US\$ 1,500,000,000 (or its equivalent in other currencies).

The Company expects to enter the CNV public offering regime during the 2019 fiscal year.

#### Inter-American Investment Corporation Loan

In December 2016, the Company and the Inter-American Investment Corporation (IIC), on behalf of the Inter-American Development Bank (IDB), signed an agreement to fund the construction of a wind farm. The aggregate loan amount is US\$ 200,000,000 and is structured in two tranches of US\$ 100,000,000, maturing in 7 and 9 years, respectively, and is destined to fund exclusively the project of constructions "Parque Eólico Manantiales Behr". The capital amortization will be performed in two quarterly payments beginning in February 2020. The loan was structured in two tranches, with the following detail:

<u>Tranche</u>	<u>Amount in US\$</u>	<u>Rate</u>
A	31,075,076	3 month Libor + 5.125%
A	12,539,359	7.16%
A	18,000,032	7.05%
A	19,506,895	7.27%
A	18,878,638	7.87%
B	100,000,000	3 month Libor + 4.8%
Total	<u>200,000,000</u>	

#### - Citigroup Global Markets Inc., Credit Suisse Securities (USA) LLC and Export Development Canada Loan

On June 14, 2017, Citigroup Global Markets Inc., Credit Suisse Securities (USA) LLC and Export Development Canada, approved the granting of a loan for Y-GEN to carry out a construction project of Loma Campana II thermal power plant with an installed power of 107 MW in the Province of Neuquén; and for Y-GEN II to undertake a construction project of El Bracho thermal power plant with an installed capacity of 267 MW in the Province of Tucumán.

The committed amount of the aforementioned loan is US\$ 219,500,000 (US\$ 70,000,000 destined to Y-GEN and the remaining amount of US\$ 149,500,000 to Y-GEN II). However, as of December 31, 2018, disbursements actually made totaled US\$ 211,973,875 (US\$ 70,000,000 for Y-GEN and US\$ 141,973,875 for Y-GEN II).

The agreed interest rate is 3-month LIBOR + 4.00% until the construction completion date and, thereafter, 3-month LIBOR + 5.75% until maturity and the term for principal repayment is 5 years (includes a 15-month grace period) with repayment of approximately 44% of principal in 15 quarterly installments commencing on December 31, 2018, and one installment for the remaining balance of approximately 56% of principal at the end of a 5-year term on June 30, 2022.

**YPF ENERGÍA ELÉCTRICA SOCIEDAD ANÓNIMA**  
**NOTES TO THE CONSOLIDATED FINANCIAL STATEMENTS**  
**AS OF DECEMBER 31, 2018 AND COMPARATIVE INFORMATION**

(Amounts expressed in thousands of Argentine Pesos, except as otherwise indicated)

In connection with the loan, Y-GEN and Y-GEN II have agreed, among other things, to contract hedging instruments as a means of protection against LIBOR fluctuations. As a result, in June 2017, the said companies executed an interest rate hedge agreement with Citibank N.A., London Branch for a 5-year term, coverage that started to apply since December 31, 2017, over an initial notional amount of approximately US\$ 156,000,000 (US\$ 106,000,000 corresponding to Y-GEN II, and the remaining amount of US\$ 50,000,000 to Y-GEN). The interest rate hedge provides that the companies will pay fixed amounts at a rate set at 1.947% and they will receive variable amounts subject to 3-months LIBOR.

At December 31, 2017, the changes in the accounting measurement regarding the swap contract were not significant. At December 31, 2018, the Company had booked a result of 26,391 as Other Comprehensive Income, included in the Statement of Comprehensive Income, generated by the measurement of the mentioned coverage instruments at fair value.

The loan contract also includes certain restrictive covenants (usually named "covenants"); the Companies have to maintain a 70% - 30% ratio between the amounts obtained under the loan and the capital contributions made prior to each disbursement period, both measured in dollars at the time they were respectively made, and also, from the date of the first principal installment repayment, they must meet a principal repayment coverage ratio measured on the basis of certain cash flows generated during the year ended at each measurement date and the principal repayments for such period, which may not be below 1.05.

As to the guarantees which are standard for this type of financing, the following may be mentioned:

- Construction guarantee until the construction completion date by GE.
- Guarantee of Members' capital contributions (today, the single shareholder).
- Foreign reserve accounts after the construction completion date, which as of December 31, 2018 amounts 1,489,031.
- Guarantee from the partners regarding the reserves until the latter reach the minimum required.
- Pledge of equipment installed in both plants.
- Pledge of the units of the Members of Y-GEN and of the Members of Y-GEN II (currently on the shares of the single shareholder).
- Pledge of the offshore bank accounts of Y-GEN and Y-GEN II.
- Assignment in trust as guarantee of all the rights of Y-GEN and Y-GEN II.

On October 18, 2018, the aforementioned partners guarantee on the reserve account was released upon reaching the minimum required funds.

**- Loans with YPF and Bajo del Toro II S.R.L. (related companies)**

In November 2015, YPF granted a loan to the Company, for the total amount of US\$ 40,000,000 with an original maturity date of February 19, 2018. The total amount regarding this loan, accrued a Libor interest rate, in a range between 6.75% and 9.5%. After the subscription of several amendments regarding the original agreement, the amount of the loan reached in April 2017 a total amount of US\$ 50,000,000, subject to the original terms and conditions regarding interest rate and due dates.

During October of 2017, YPF granted the collection right of US\$ 30,000,000 related to the aforementioned loans regarding Bajo del Toro II S.R.L. The maturity date is August 9, 2018, and the applicable rate is Libor 3M+ 6.00%. At the maturity date, the loan balance was canceled.

Moreover, the Company capitalized 303,747 related to a loan from YPF, and offset 49,224 for the sale price of its share in Area Ramos Consortium (Nota 3.a)).

**YPF ENERGÍA ELÉCTRICA SOCIEDAD ANÓNIMA**  
**NOTES TO THE CONSOLIDATED FINANCIAL STATEMENTS**  
**AS OF DECEMBER 31, 2018 AND COMPARATIVE INFORMATION**

(Amounts expressed in thousands of Argentine Pesos, except as otherwise indicated)

**- Citi NY Loans**

In March 2018, the Company took out a loan from Citibank NY for a total amount of US\$ 30,000,000 with quarterly interest at 3-month LIBOR rate + 1.6%, and principal bullet repayment at maturity, on August 28, 2018. After such date, the Company extended the maturity of the loan through February 28, 2019, at 3-month LIBOR rate + 2.25%.

On June 28, 2018, the Company took out a second loan with the same bank in the amount of US\$ 30,000,000 with quarterly interest at 3-month LIBOR rate + 1.85%, and principal bullet repayment at maturity, on June 28, 2019.

The proceeds of both loans are used to finance working capital.

**- Loans with Banco de Galicia y Buenos Aires S.A.**

On August 17, 2018, the Company took out a loan from Banco de Galicia y Buenos Aires S.A. for a total amount of US\$ 20,000,000 with annual interest at a fixed rate of 5.00% and bullet repayment of principal at maturity, on August 17, 2019.

In addition, on September 3, 2018, the Company took out a second loan from the same bank in the amount of US\$ 20,000,000 with quarterly interest at a fixed rate of 8.35% maturing on September 3, 2021. The principal amount of the loan is payable in nine quarterly installments as from month 12.

The proceeds of both loans will be used to finance investment projects, including working capital.

The agreements related to said loans have financial commitment clauses (covenants) throughout the terms of the loans, which include leverage ratio and debt coverage ratio.

**- Loan with BBVA Banco Francés S.A.**

On August 17, 2018, the Company obtained a loan from BBVA Banco Francés S.A. for an aggregate amount of US\$ 30,000,000 with biannual interest at an 8.40% fixed rate and final maturity on August 17, 2021. The principal of the loan is repayable in three annual installments.

The proceeds of such loan will be used to finance working capital and investments, and capital assets.

The agreements related to said loans have financial commitment clauses (covenants) throughout the terms of the loans, which include leverage ratio and debt coverage ratio.

**- Loan with Itaú Unibanco S.A., Nassau Branch**

On September 24, 2018, the Company obtained a loan from Itaú Unibanco S.A., Nassau Branch, for an aggregate amount of US\$ 50,000,000 with quarterly interest at 3-month LIBOR rate + 5.00% and bullet repayment of principal at maturity, on September 24, 2019.

The proceeds of this loan will be used to cover general financing needs.

The agreements related to said loans have financial commitment clauses (covenants) throughout the terms of the loans, which include leverage ratio and debt coverage ratio.

**- Syndicated loan granted by Banco Latinoamericano de Comercio Exterior, S.A. and Industrial and Commercial Bank of China (Argentina) S.A.**

On November 29, 2018, the Company obtained a syndicated loan from Banco Latinoamericano de Comercio Exterior S.A. and Industrial and Commercial Bank of China S.A. (Argentina) as placement agents. The aggregate loan amount is US\$ 75,000,000 with quarterly interest at a 3 month Libor rate + 5.75% and final maturity on November 23, 2021. The principal amount of this loan is repayable in four equal monthly installments in months 29, 24, 30 and 36.

The funds of this loan will be used to finance capital investments and other general funding needs.

The agreements related to said loans have financial commitment clauses (covenants) throughout the terms of the loans, which include leverage ratio and debt coverage ratio.

Banco Latinoamericano de Comercio Exterior S.A. acts as administrative agent of this syndicated loan.

**YPF ENERGÍA ELÉCTRICA SOCIEDAD ANÓNIMA**  
**NOTES TO THE CONSOLIDATED FINANCIAL STATEMENTS**  
**AS OF DECEMBER 31, 2018 AND COMPARATIVE INFORMATION**

(Amounts expressed in thousands of Argentine Pesos, except as otherwise indicated)

**14. ACCOUNTS PAYABLE**

	<u>12.31.2018</u>	<u>12.31.2017</u>	<u>01.01.2017</u>
Trade	934,147	611,219	538,294
Related parties (Note 26)	3,631,382	268,209	101,094
	<u>4,565,529</u>	<u>879,428</u>	<u>639,388</u>

Accounts payables are non-interest bearing and are normally settled on 90-day terms.

**15. REVENUES**

<u>Type of good or services</u>	<u>For the year ended December 31,</u>	
	<u>2018</u>	<u>2017</u>
Energía Base <sup>(1)</sup>	3,268,971	1,363,882
Revenues under PPAs	3,448,667	31,165
Steam sales	386,509	-
Other services income	20,758	75,623
	<u>7,124,905</u>	<u>1,470,670</u>

<u>By Customer</u>	<u>For the year ended December 31,</u>	
	<u>2018</u>	<u>2017</u>
CAMMESA <sup>(2)</sup>	5,881,414	1,363,882
YPF <sup>(2)</sup>	1,119,111	19,448
Y-GEN <sup>(2) (3)</sup>	10,209	37,325
Y-GEN II <sup>(2) (3)</sup>	10,549	38,298
UT Loma Campana <sup>(2)</sup>	69,922	11,717
Profertil S.A. <sup>(2)</sup>	8,979	-
Coca- Cola FEMSA de Buenos Aires S.A.	9,222	-
Toyota Argentina S.A.	9,114	-
Other	6,385	-
	<u>7,124,905</u>	<u>1,470,670</u>

(1) Power generation from Res. SEE 19/2017 and earlier..

(2) Related companies (See Note 26).

(3) Companies controlled since March 31, 2018

**16. EXPENSES BY NATURE**

The Group presents the statement of comprehensive income by classifying expenses according to their function as part of the "Production costs" and "Administrative and selling expenses" lines. The following additional information is disclosed as required, on the nature of the expenses and their relation to the function within the Group for the years ended December 31, 2018 and 2017:

	<u>For the year ended December 31, 2018</u>		
	<u>Production costs <sup>(1)</sup></u>	<u>Administrative and selling expenses <sup>(1)</sup></u>	<u>Total</u>
Depreciation of property, plant and equipment	1,279,867	-	1,279,867
Consumable materials and supplies	50,153	1,564	51,717
Banking expenses	4	2,742	2,746
Rentals	3,865	13,433	17,298
Fees and compensation for services	17,539	63,056	80,595
Other personnel expenses	26,072	55,506	81,578
Preservation, repair and maintenance	148,733	5,682	154,415
Insurance	89,596	305	89,901
Salaries and social security taxes	422,069	108,151	530,220
Operation services and other contracts	121,960	-	121,960
Transportation, products and charges	153,312	-	153,312
Fuel, gas, energy and miscellaneous	44,363	-	44,363
Taxes, rates and contributions	6,779	272,924	279,703
Publicity and advertising expenses	-	1,806	1,806
Research and development	6,343	-	6,343
Miscellaneous	30,970	19,245	50,215
<b>Total 2018</b>	<u>2,401,625</u>	<u>544,414</u>	<u>2,946,039</u>

**YPF ENERGÍA ELÉCTRICA SOCIEDAD ANÓNIMA**  
**NOTES TO THE CONSOLIDATED FINANCIAL STATEMENTS**  
**AS OF DECEMBER 31, 2018 AND COMPARATIVE INFORMATION**

(Amounts expressed in thousands of Argentine Pesos, except as otherwise indicated)

<b>For the year ended December 31, 2017</b>			
	<b>Production costs <sup>(1)</sup></b>	<b>Administrative and selling expenses <sup>(1)</sup></b>	<b>Total</b>
Depreciation of property, plant and equipment	76,840	-	76,840
Consumable materials and supplies	40,950	1,242	42,192
Banking expenses	-	512	512
Rentals	432	11	443
Fees and compensation for services	5,259	71,428	76,687
Other personnel expenses	17,599	7,639	25,238
Preservation, repair and maintenance	57,777	-	57,777
Insurance	17,944	827	18,771
Salaries and social security taxes	125,284	31,321	156,605
Operation services and other contacts	22,307	-	22,307
Transportation, products and charges	72,417	-	72,417
Fuel, gas, energy and miscellaneous	1,748	-	1,748
Taxes, rates and contributions	-	50,829	50,829
Publicity and advertising expenses	-	8	8
Miscellaneous	5,089	19,691	24,780
<b>Total 2017</b>	<b>443,646</b>	<b>183,508</b>	<b>627,154</b>

(1) Net of discontinued operations (Note 18).

## 17. NET FINANCIAL RESULTS

### Financial income

	<b>For the year ended December 31,</b>	
	<b>2018</b>	<b>2017</b>
Interest income and other	200,871	128,971
Exchange difference on liabilities	1,084,570	79,798
<b>Total financial income</b>	<b>1,285,441</b>	<b>208,769</b>

### Financial loss

	<b>For the year ended December 31,</b>	
	<b>2018</b>	<b>2017</b>
Interest loss	(606,025)	(78,185)
Exchange difference on assets	(2,001,938)	(119,005)
<b>Total financial loss</b>	<b>(2,607,963)</b>	<b>(197,190)</b>
<b>Total net financial results</b>	<b>(1,322,522)</b>	<b>11,579</b>

## 18. DISCONTINUED OPERATIONS – RAMOS CONSORTIUM

	<b>For the year ended December 31,</b>	
	<b>2018</b>	<b>2017</b>
Revenues	41,502	449,901
Production costs	(22,048)	(131,986)
<b>Gross profit</b>	<b>19,454</b>	<b>317,915</b>
Administrative expenses and selling expenses	(4,077)	(27,054)
<b>Net profit for the year before income tax from discontinued operations</b>	<b>15,377</b>	<b>290,861</b>
Income tax for the year	(2,081)	(96,874)
<b>Net profit for the year from discontinued operations</b>	<b>13,296</b>	<b>193,987</b>

The total net income for the participation of the Company in the Ramos Consortium for the year ended December 31, 2017, amounted to 193,987.

Net cash flow from operating activities of the Ramos Consortium is as follows:

	<b>For the year ended December 31,</b>	
	<b>2018</b>	<b>2017</b>
Operating activities	18,784	303,333
Earnings per share (Note 20)		
<b>For the year ended December 31,</b>		
	<b>2018</b>	<b>2017</b>
Basic and diluted earnings per share from discontinuing operations	0.004	0.128



**YPF ENERGÍA ELÉCTRICA SOCIEDAD ANÓNIMA**  
**NOTES TO THE CONSOLIDATED FINANCIAL STATEMENTS**  
**AS OF DECEMBER 31, 2018 AND COMPARATIVE INFORMATION**

(Amounts expressed in thousands of Argentine Pesos, except as otherwise indicated)

## 19. SHAREHOLDERS' EQUITY

As of December 31, 2017, the Company's capital stock amounts to 2,506,555,895 represented by book entry ordinary shares, with a par value of 1, with the right to one vote per share, which is subscribed, paid in, issued and registered.

On January 12, 2018, the Extraordinary General Shareholders' Meeting decided to approve a debt capitalization and capital increase in the amount of 303,747 represented by 303,747,096 book entry ordinary shares, with a par value 1 and with the right to one vote per share, fully subscribed by the shareholder YPF.

On March 20, 2018, the Ordinary and Extraordinary General Shareholders' Meeting resolved to increase the capital stock by 936,767 from 2,810,303 to 3,747,070, setting a share premium of US\$ 0.243934955 per share. This increase was represented by 936,767,364 Class B book entry ordinary shares, with a par value 1 with the right to one vote per share. The total subscription price of the new shares amounts to US\$ 275,000,000 comprised as follows: a) US\$ 135,000,000 paid by GE EFS Power Investment B.V. on that date and b) US\$ 140,000,000 on the day it is one calendar year from, and including, the day of the Shareholders' Meeting. On March 20, 2019, this contribution was integrated.

In this way, as of December 31, 2018 the shareholders of YPF EE after the issuance of shares is as follows:

Shareholder	Number of Shares	Participation in the capital stock	Class of Share
YPF	2,723,826,879	72.69218%	A
OPESSA	86,476,112	2.30783%	A
GE	936,767,364	24.99999%	B
<b>Total</b>	<b>3,747,070,355</b>	<b>100.00000%</b>	

On April 26, 2018, the Ordinary Shareholder's Meeting approved the financial statements of YPF EE for fiscal year ended December 31, 2017, and resolved as follows regarding allocation of profits: a) to allocate the amount of 46,404 to set up a Legal Reserve pursuant to section 70, first paragraph of the LGS, b) to allocate the amount of 881,681 to set up a Voluntary Reserve pursuant to section 70, third paragraph of the LGS.

## 20. EARNINGS PER SHARE

Earnings per share amounts are calculated by dividing net income for the year attributable to equity holders of the parent by the weighted average number of ordinary shares during the period. There are no transactions or items generating a dilution effect.

The following reflects information on income and the number of shares used in the earnings per share computations:

	<b>For the year ended December 31,</b>	
	<b>2018</b>	<b>2017</b>
Net profit for the year attributable to holders of the parent company:		
Continuing operations	4,492,116	652,770
Discontinuing operations	13,296	193,987
	<u>4,505,412</u>	<u>846,757</u>
Weighted average per share	<u><b>3,534,332</b></u>	<u><b>1,515,936</b></u>
Basic and diluted earnings (loss) per share from continued and discontinued operations:		
- Basic and diluted	1.275	0.559
Basic and diluted earnings (loss) per share from continued operations		
- Basic and diluted	1.271	0.431

There have been no transactions involving ordinary shares or potential ordinary shares between the reporting date and the date of issuance of these consolidated financial statements that may produce a dilution effect.

**YPF ENERGÍA ELÉCTRICA SOCIEDAD ANÓNIMA**  
**NOTES TO THE CONSOLIDATED FINANCIAL STATEMENTS**  
**AS OF DECEMBER 31, 2018 AND COMPARATIVE INFORMATION**

(Amounts expressed in thousands of Argentine Pesos, except as otherwise indicated)

**21. RESTRICTION ON RETAINED EARNINGS**

Pursuant to the Argentine Companies Act and the corporate bylaw, 5% of the net profit for the year must be allocated to the legal reserve until such reserve reaches 20% of the capital stock.

**22. INFORMATION REQUIRED BY ARTICLE No. 63 OF LAW No. 19,550 - ASSETS AND LIABILITIES IN CURRENCY IN CURRENCIES OTHER THAN THE PESO**

The following table provides the assets and liabilities in currencies other than the peso for the financial statement as of December 31, 2018, December 31, 2017 and January 1, 2017.:

Account	12.31.2018			12.31.2017		01.01.2017	
	Class and amount of currencies other than peso	Exchange rate <sup>(1)</sup>	Booked amount in pesos	Class and amount of currencies other than peso	Booked amount in pesos	Class and amount of currencies other than peso	Booked amount in pesos
<b>NON-CURRENT ASSETS</b>							
Investment in financial assets	US\$	1,864	37.5	69,901	-	-	-
<b>Total of Non-Current Assets</b>				<b>69,901</b>	<b>-</b>	<b>-</b>	<b>-</b>
<b>CURRENT ASSETS</b>							
Other receivables	US\$	140,751	37.5	5,278,163	US\$	37	683
Trade receivables	US\$	95,756	37.5	3,590,856	US\$	11,277	209,192
Other financials assets	US\$	39,707	37.5	1,489,032	US\$	-	-
Cash and cash equivalents	US\$	107,679	37.5	4,037,970	US\$	3,166	58,737
<b>Total of Current Assets</b>				<b>14,396,021</b>		<b>268,613</b>	<b>759,412</b>
<b>Total of Assets</b>				<b>14,465,922</b>		<b>268,613</b>	<b>759,412</b>
<b>NON-CURRENT LIABILITIES</b>							
Loans	US\$	487,868	37.7	18,392,637 <sup>(2)</sup>	US\$	167,816	3,129,772 <sup>(2)</sup>
Provision	-	-	-	-	US\$	4,893	91,261
<b>Total of Non-Current Liabilities</b>				<b>18,392,637</b>	<b>US\$</b>	<b>3,221,033 <sup>(2)</sup></b>	<b>US\$</b>
<b>CURRENT LIABILITIES</b>							
Trade payables	US\$	51,076	37.7	1,925,556	US\$	11,400	212,606
	EUR	5,986	43.16	258,375	EUR	1,965	44,109
Loans	US\$	173,694	37.7	6,548,279 <sup>(3)</sup>	US\$	53,210	992,375 <sup>(3)</sup>
Provisions	-	-	37.7	-	US\$	783	14,594
Other Liabilities	US\$	2,631	37.7	99,189	-	-	-
<b>Total of Current Liabilities</b>				<b>8,831,399</b>		<b>1,263,684</b>	<b>219,345</b>
<b>Total of Liabilities</b>				<b>27,224,036</b>		<b>4,484,717</b>	<b>1,962,352</b>

US\$: U.S. Dollar.  
 EUR: Euro.

- (1) At the Banco de la Nación Argentina exchange rate prevailing as of December 31, 2018.  
 (2) Correspond to the nominal amount owed, which are disclosed in the caption "Loans" for the amount of 18,256,570 and 3,088,604 as of December 31, 2018, and 2017, respectively, net of transaction fees and cost.  
 (3) Corresponds to the nominal amount owed, which is exposed in Loans in the amount of 6,514,408 and 992,375 as of December 31, 2018, and 2017, respectively, net of commissions and transaction fees.

**YPF ENERGÍA ELÉCTRICA SOCIEDAD ANÓNIMA**  
**NOTES TO THE CONSOLIDATED FINANCIAL STATEMENTS**  
**AS OF DECEMBER 31, 2018 AND COMPARATIVE INFORMATION**

(Amounts expressed in thousands of Argentine Pesos, except as otherwise indicated)

**23. MAIN CONTRACTUAL COMMITMENTS AND GUARANTEES GRANTED**

The main contractual commitments assumed and guarantees granted by the Group are disclosed below:

**a) Agreements entered into with CAMMESA - Loma Campana generation project**

On October 28, 2015, a financing and receivables assignment agreement was entered into between the Company and CAMMESA to settle the payables to the Company under the 2008-2011 "Agreement to ensure generation availability and project technical operation, increase thermal generation availability and adjust the compensation for generation".

The purpose of the agreement signed with CAMMESA is to install a turbo gas generating unit in a new plant located in Loma Campana, in the Loma Campana field, Añelo, Province of Neuquén (hereinafter, the "Project").

By virtue of this agreement, CAMMESA provided the Company with financing equal to the receivables pursuant to SE Resolution No. 406/2003 due as of the date of the agreement plus the receivables under SE Resolution No. 95/2013 accumulated through December 2015, plus the related interest (jointly, the "receivables"). The Company undertook to use them solely and exclusively to implement the project.

As of December 31, 2017, the Company received an advance payment of the agreed-upon financing for approximately 747 million, which was used to implement the project and by virtue of which CAMMESA, after verifying that the amounts were used as defined in the agreement, issued the definitive settlements of sales related to the unpaid receivables in order to apply them for settling the financing in proportion to the amounts transferred as partial advances. As of December 31, 2018, the receivables accrued in November and December 2015, and the receivables added to the loan-for-consumption agreement accrued from January 2016 to January 2017 approximately 110 million are pending of collection.

**b) Manantiales Behr Wind Farm**

In 2016, the Company designed and started to build the Group's first wind farm. The wind farm was built in YPF's field called "Manantiales Behr", which is located 20 kilometers away of the City of Comodoro Rivadavia, Province of Chubut. The wind farm consist of 30 V112 3.3 MW Vestas mills.

The work began in September 2016 and was divided into two stages. The first stage of the wind farm obtained the commercial operation permit on July 25, 2018 and the second stage obtained the commercial operation permit on December 22, 2018.

The energy generated is mainly made available to YPF through a power supply contract denominated in US dollars, for a 15-year term which will allow YPF to meet its regulatory obligations regarding the percentage of renewable energy required under Law No 27,191. The remaining generation will be sold on the MATER to specific industries.

**c) Loma Campana II and El Bracho Projects**

On May 13, 2016, the companies Y-GEN and Y-GEN II were organized to make a tender in the bidding process published by the Resolution 21/2016 of Ministry of Energy and Mining, which called for bids to generate thermal energy and power, which, if awarded, would sign a power sales agreement with CAMMESA for a 10-year term each, as offered, and with a price stated in US dollars. The companies organized made bids to build new thermal generation plants in Neuquén (Loma Campana, Añelo) and in Tucumán (El Bracho), which were finally awarded.

As of December 31, 2018, 100% of both companies' capital stock is related to the Company, while as of December 31, 2017, 66.67% of both companies' capital stock was related to the Company ("Managing Shareholder") and the remaining 33.33% was related to GE Capital Global Energy Investments B.V. (formerly, Guayama PR Holdings) ("Non Managing Shareholder") of the General Electric Group, maintaining until that date joins control of these companies.

In agreement with Resolution No. 21/2016 issued by the Ministry of Energy, Y-GEN and Y-GEN II provided CAMMESA with performance bonds for US\$ 51,723,732, to secure compliance with its obligations under the power purchase agreements signed in August and July 2016, respectively.

The Loma Campana II thermal plant located in the Province of Neuquén and operated by Y-GEN with an installed power of 107 MW, was authorized to operate on November 30, 2017.

Moreover, on January 27, 2018, the thermal plant El Bracho located in the Province of Tucumán and operated by Y-GEN II with an installed power of 267 MW, was authorized to operate.

These projects were funded as a "project financing" without recourse against the Company (today the single shareholder of Y-GEN and Y-GEN II). The loan is secured by:

**YPF ENERGÍA ELÉCTRICA SOCIEDAD ANÓNIMA**  
**NOTES TO THE CONSOLIDATED FINANCIAL STATEMENTS**  
**AS OF DECEMBER 31, 2018 AND COMPARATIVE INFORMATION**

(Amounts expressed in thousands of Argentine Pesos, except as otherwise indicated)

- A pledge on each company's financed assets, and;
- A pledge on membership interests, today shares, of Y-GEN and Y-GEN II.

In the bidding process launched by Resolution SEE No. 287/2017, Y-GEN II was awarded a new PPA for 15 years with CAMMESA, for the closing of the gas turbine cycle resulting from the previous bidding process called under SEE Resolution No. 21/2016, which will add 198 MW of installed capacity to the already operative 267 MW. A remunerative price denominated in US Dollars is fixed for the generated power and energy. The construction of this work is underway and the estimated commercial operation date will occur in the second quarter of 2020. In order to secure the committed commercial operation date Y-GEN II has granted to CAMMESA a surety bond in the amount of US\$ 26,373,600.

**d) La Plata Co-generation I**

With the purchase from Central Puerto S.A. of the 128-MW co-generation plant located in La Plata Industrial Complex, owned by YPF, the Company is committed under a 15-year steam supply contract to deliver 200 tons per hour. The electric power generated by this plant will be delivered to the MEM and its price is established in accordance with SEE Resolution No. 19/2017.

**e) La Plata Co-generation II**

Also, under the bidding process decided by SEE Resolution No. 287/2017, YPF EE was awarded a 15-year PPA with CAMMESA through the construction project of a new 85-MW co-generation power plant in La Plata Refinery, owned by YPF. The price for the generated power and energy is stated in US Dollars. The work construction is underway and its commercial operation date is expected to occur in the second quarter of 2020. With the purpose of ensuring the committed commercial operation date, the Company has granted to CAMMESA a surety bond in the amount of USD 8,352,144. Besides, negotiations are still being held regarding the agreement for the sale of steam to YPF.

**f) The Cañadón León wind farm**

In the second bidding process known as "RenovAR 2.0", the Company was awarded a 20-year PPA with CAMMESA through the construction of Cañadón León Wind Farm with an installed capacity of 99 MW, that will be located in the Province of Santa Cruz, 25 kilometers away from the City of Caleta Olivia and about 100 kilometers away from the Manantiales Behr Wind Farm. Likewise, the Company has furnished a bid bond for an amount of US\$ 3,465,000 by means of surety bond.

**g) Los Teros wind farm**

The Company is currently building Los Teros Wind Farm, which was developed by Luz del Cerro S.A., today wholly owned by the Company. This wind farm will have an installed capacity of 122.55 MW and has obtained priority dispatch in the MATER for its whole capacity. The Wind Farm will be built in two stages, and the installation of 72.2 MW is expected to take place in the first stage. With the purpose of ensuring dispatch priority of the energy generated by such MWs, a surety bond has been furnished in the amount of US\$ 18,050,000. The second stage will comprise 50.35 MW. In order to ensure the commercial operation of this stage on the committed date a surety bond has been granted in the amount of US\$ 12,587,500. The commercial operation of both stage is expected during 2020.

As of the date hereof, contracts have been signed with industries for 18% of the wind farm capacity, whereas the rest of the energy to be produced is in undergoing contract negotiations.

**h) Los Teros II wind farm**

The Company is in the previous phases of analysis of the construction project of the Los Teros II Wind Farm, which was developed by Luz del Cerro S.A., today wholly owned by the Company. This wind farm will have an installed capacity of 49.5 MW and has obtained priority dispatch in the MATER for its whole capacity. In order to secure the dispatch priority for that MWs, it has granted a surety bond in the amount of US\$ 12,500,000. The commercial operation of both stage is expected during 2020.

**i) Operating leases commitments**

As of December 31, 2018, the main contracts in which the Group is the lessee correspond to property lease and land lease in which power plants and equipment are installed of the subsidiary Y-GEN with YPF and the usufruct contracts with the owners of the land where the Los Teros wind farm will be located.

**YPF ENERGÍA ELÉCTRICA SOCIEDAD ANÓNIMA**  
**NOTES TO THE CONSOLIDATED FINANCIAL STATEMENTS**  
**AS OF DECEMBER 31, 2018 AND COMPARATIVE INFORMATION**

(Amounts expressed in thousands of Argentine Pesos, except as otherwise indicated)

As of December 31, 2018, the future payments of these contracts are as follows:

	<u>Up to one year</u>	<u>Between 1 and 5 years</u>	<u>More than 6 years</u>
Estimate future payments	39,203	120,860	339,860

**j) Finance leases commitments**

During the year 2017, the Company entered into 6 finance lease contracts with Banco Supervielle S.A. to acquire motor generators. Three of these agreements accrue interest at an 8.35% annual rate will be paid as of April 30, 2022; two agreements accrue interest at a 7.75% annual rate will be paid as of December 31, 2022, and another agreement accrue interest at a 7.75% annual rate will be paid as of January 31, 2023. All the agreements are payed in a monthly basis.

The due dates of the finance lease payables as of December 31, 2018, are as follows:

<u>Terms</u>	<u>Finance leases <sup>(1)</sup></u>
Up to 1 year	50,424
1 to 4 years	159,742
	<u>210,166</u>

(1) Net of interest to be accrued for 15,048 and 18,732 up to 1 year and over 1 year, respectively.

**24. REGULATORY FRAMEWORK**

**24.1. Regulatory framework for the electric industry**

Law No. 24,065, passed in 1992 and regulated by Executive Order No. 1,398/92, has established the current basic regulatory framework for the electricity sector (the "Regulatory Framework"). This Regulatory Framework is supplemented by the SE's regulations for the generation and commercialization of electric power, including the former SEE Resolution No. 61/1992 "Procedures for Operations Scheduling, Load Dispatch and Price Calculation", as amended and supplemented.

The ENRE is the agency that regulates, oversees and controls the electric power industry and, in such capacity, it is responsible for the enforcement of Law No. 24,065.

CAMMESA is responsible for the technical dispatch, planning and economic organization of the SADI and the MEM that also acts as a collection agency for all MEM agents.

By the end of 2015, Decree 134/2015 was enacted, in which, given the current situation of the Argentine electricity system, the PEN declared the Emergency of the National Electricity Sector until December 31, 2017. This Decree instructs the MEM to prepare and put into effect an action plan in relation to the segments of generation, transport and distribution of electrical energy in order to adapt the quality and safety of the electricity supply and guarantee the provision of the service public of electricity in adequate technical and economic conditions.

Among the main amending and supplementing regulations governing the sector, the following resolutions are noteworthy, with regard to the electric power generation business:

- **SE Resolution No. 95/2013:** established a new remuneration scheme based on: a) remuneration of fixed costs, b) remuneration of variable non-fuel costs, c) direct additional remuneration and d) indirect additional remuneration, which would be destined to create a trust for the development of electric power infrastructure works. To access these remunerations it was necessary to accept the terms and conditions established by the regulation. The Company accepted this regime on October 17, 2013 and retroactively as of February 1, 2013. The resolution also suspended, until the SE states otherwise, the signing of new contracts and / or the renewal of existing contracts between generators and large users (with the exception of the contracts framed in Resolution SE No. 1281 / 2006 "Energía Plus" and Resolution SE No. 220/2007, among others). It also provided that, from the date of expiration of existing contracts, large users should make their energy purchases through CAMMESA.
- **Resolution SE No. 529/2014:** this resolution replaced the compensation scheme contemplated in Resolution SE No. 95/2013, increasing the rate schedule of the four remuneration concepts established therein. Regarding to fixed costs remuneration, it established an increase related to the availability of each Generating Agent. It also incorporated a new remuneration scheme for non-recurring maintenance whose objective was the financing of

**YPF ENERGÍA ELÉCTRICA SOCIEDAD ANÓNIMA**  
**NOTES TO THE CONSOLIDATED FINANCIAL STATEMENTS**  
**AS OF DECEMBER 31, 2018 AND COMPARATIVE INFORMATION**

(Amounts expressed in thousands of Argentine Pesos, except as otherwise indicated)

- major maintenance subject to approval by the SE. This resolution was retroactively applied from the economic transactions corresponding to the month of February 2014 for those generators that have adhered to Resolution SE No. 95/2013, as is the case of the Company.
- **Resolution SE No. 482/2015:** this resolution defined adjustments in the compensation scheme contemplated in Resolution SE No. 529/2014, increasing the rate schedule of the five remunerative concepts established therein. It also incorporated a new specific contribution scheme called "Resources for Investments of FONINMEM 2015-2018" to be assigned to those generators participating in the investment projects approved or to be approved by the SE and established a new incentive scheme for the Production of Energy and Operational Efficiency for the generating agents included. This resolution is retroactively applied from the economic transactions corresponding to the month of February 2015 for those generators that have adhered to Resolution SE No. 95/2013, as is the case of the Company.
  - **Resolution of the SEE No. 22/2016 date:** the SEE modified Resolution SE No. 482/2015 and adjusted the components of the remuneration received by the generating agents that have adhered to Resolution SE No. 95/2013, 529/14 and 482/2015. The resolution modified the remunerative components of the economic transactions retroactive to February 2016.
  - **SEE Resolution 19/2017:** dated February 2, 2017, established that the Agents of the MEM may declare Guaranteed Availability Offers to subscribe Guaranteed Availability Commitments (CoDiG), for the power and energy of the installed generating units, in accordance with the provisions of this Resolution. The power that may be subject to Guaranteed Availability Offers will be remunerated based on a payment for monthly available power subdivided into a real available power, a guaranteed power offered, and an assigned power; and another for energy generated and operated. The remunerations will be calculated in US dollars convertible to Argentine pesos at the exchange rate corresponding to the last business day of the month to which the operation corresponds, and the Sale Liquidations will have an expiration date. In addition, in reference to the payment of economic transactions, the Secretariat of Electric Energy later established that the commercial document contemplating the exchange rate of the date prior to the expiration date should be attached thereto. Likewise, a mechanism of Incentives for Operating Efficiency is established for thermal power plants based on compliance with fuel consumption targets.
  - **SEE Resolution No. 21/2016:** calls Generators, Self-Generators and Co-Generators to bid for the provision of additional thermal generation and associated electric power production capacity, with the commitment to make it available at the MEM in summer (2016/2017 and 2017/2018) and winter 2017.
  - **SEE Resolution No. 287 -E/2017:** under this resolution an open call for tenders was launched to incorporate new efficient electric energy generation through the Closing of Open Cycles and Co-Generation, where 40 offers were received for more than 3,300 MWs of power.
  - **SEE Resolution No 820 -E/2017:** under this resolution, 3 co-generation projects were awarded for 506 MWs corresponding to the first round. Subsequently, in October, by Resolution No. 926/17, 9 additional projects were awarded (1 Co-generation + 8 Closing of Cycles) for a total of 1,304 MWs corresponding to the second round.
  - **Resolution 1-E/2018:** in January 2018, that introduces changes in the dispatch priority allocation mechanism and determines that projects where purchase orders have already been issued for all the electromechanical items of equipment —prior to issuance of Resolution No. 281/2017— will be given priority for dispatch.
  - **Resolution No. 46-E/2018:** establishes the new prices at the entry point into the transportation system for natural gas, for each basin of origin, which will be related to natural gas purchases used for to the power generation to be commercialized within the MEM or, in general, used for the power distribution public service. Average maximum price 4.2US\$/MMBtu.
  - **Resolution 70-SGE/2018:** This resolution issued in November 2018, allows generators to purchase their own fuel on an optional basis. The request to declare the production variable cost (PVC) is voluntary and renewable on each fortnight for the authorized groups. The costs of generation with their own fuels will be valued according to the recognition of the variable production costs recognized by CAMMESA. Besides, CAMMESA will continue with the commercial management and the dispatch of fuel for those agents which decide not to use to this option.
  - **Resolution 25-SGE/2018:** Through this Resolution IEASA is instructed to sell to CAMMESA the fuels required by the latter to supply the demand, at the acquisition and commercialization cost of such fuels, declaring to CAMMESA such costs on the same dates on which generators have to declare the Production Variable Costs.
  - **Resolution No. 1,085-E/2017:** issued in November 2017, sets forth that as from December 2017, Transmission System-related costs will be distributed according to demand, deducting costs allocated to Generators:

**YPF ENERGÍA ELÉCTRICA SOCIEDAD ANÓNIMA**  
**NOTES TO THE CONSOLIDATED FINANCIAL STATEMENTS**  
**AS OF DECEMBER 31, 2018 AND COMPARATIVE INFORMATION**

(Amounts expressed in thousands of Argentine Pesos, except as otherwise indicated)

Connection and Transformation Costs. Transmission prices are stabilized and payable by Distributors and calculated in the Seasonal Tariff Schedules and Quarterly Tariff Reschedules. Each Distributor will have a stabilized price for Transmission by Extra-High Voltage Lines and for Transmission by Trunk Distribution.

- **Resolution 1-SRRyME/2019:** On February 28, 2019, with the purpose of securing sustainability of the wholesale electricity market, the Secretariat of Renewable Resources and Electricity Market issued Resolution No. 1-SRRyME/2019, pursuant to which the remuneration criteria established in Resolution 19/2017 of the former Secretary of Electric Energy were adjusted to economically reasonable and efficient conditions, which may be assigned and/or transferred to the demand.

Like Resolution No. 19/2017, Resolution No. 1 will be provisionally applied until gradual definition and implementation of the regulatory mechanisms to achieve the autonomous, competitive and sustainable operation of the electricity market that will allow for the free interaction of supply and demand, and a technical, economic and operating functioning towards the integration of the different generation technologies to ensure a reliable system at a minimum cost.

The remuneration to authorized thermal generators is composed of a payment for the monthly available power, a payment for generated power and another for operated power.

a. Remuneration for available power

Power availability remuneration is subdivided into a base price associated to Actual Power Availability (DRP, by its acronym in Spanish) and a price for guaranteed power in compliance with the Offered Guaranteed Power (DIGO, by its acronym in Spanish). Power remuneration will be adjusted depending on the actual usage factor of generation equipment.

The DRP remuneration will range from 3,050 to 5,200 U\$\$/MW-month, according to the technology made available for the system and the DIGO remuneration will be 7,000 U\$\$/MW-month for winter and summer periods and 5,500 U\$\$/MW for the rest of the year.

b. Remuneration for Generated Energy

The remuneration for conventional thermal generation will contemplate as a maximum, per type of fuel consumed by each generation unit, the non-fuel variable costs, which are 4 U\$\$/MW hour for equipment consuming Natural Gas, 7 U\$\$/MW hour for Fuel Oil or Gasoil, 10 U\$\$/MW hour for Biofuels and 12 U\$\$/MW hour for mineral coal.

c. Remuneration for Operated Energy

Additionally, generators will receive a monthly remuneration for Operated Energy, represented by the integration of hourly power capacities for the period, valued at 1.4 U\$\$/MWh for any type of fuel. The hourly volume of Operated Energy must correspond to the optimum dispatch in order to comply with the energy and reserves assigned.

A generation plant that has declared the option to purchase fuels for the generation of energy, which upon request does not have sufficient fuel for the delivery, will lose its delivery order until, if necessary, CAMMESA shall assign fuel to it for its operation, and the remuneration concepts mentioned above will be reduced by 50% of their value.

Remuneration is denominated in US Dollars and is payable at the reference exchange rate of the date prior to maturity date.

Renewable energy sources

- In 2006, Law No. 26,190 was enacted, which established a National Promotion Regime for the use of renewable energy sources for the production of electricity, complementary to the regime established by Law No. 25,019 and its regulatory standards, which had already declared of national interest wind and solar power generation.
- In October 2015, Law No. 27,191 was enacted, which amended Law No. 26,190, " National Scheme for Promotion of the Use of Renewable Energy Sources for Electric Power Production ". Amendments to this law seek to establish a legal framework encouraging investments in renewable energies and promoting the diversification of the national energy matrix, increasing the share of renewable sources in the Argentine electricity market. Additionally, this law that, among other measures, requires Large Users to reach a minimum 8% of their electricity energy consumption with energy from renewable sources in 2018 and 20% in 2025. The laws are regulated in 2016 by a PEN Executive Order No. 53 establishing that, those who elect to comply by purchasing or by through self-generation or cogeneration, must expressly express their decision before the Application Authority in terms the latest determines. Otherwise, they will automatically be included in the joint purchase mechanism that CAMMESA will carry out.

**YPF ENERGÍA ELÉCTRICA SOCIEDAD ANÓNIMA**  
**NOTES TO THE CONSOLIDATED FINANCIAL STATEMENTS**  
**AS OF DECEMBER 31, 2018 AND COMPARATIVE INFORMATION**

(Amounts expressed in thousands of Argentine Pesos, except as otherwise indicated)

Among the main provisions of Law No. 27,191 and its regulations, the following can be highlighted:

- Projects entitled, including self-generators and co-generators (non-fossil), will be able to access the promotion scheme.
- A public trust fund called the Fund for the Development of Renewable Energies will be created, which will be constituted, among other trust assets, by resources from the National Treasury (not less than 50% of the savings in fossil fuels due to the incorporation of renewable sources).
- A specific charge will be applied to the users to guarantee the fulfillment of the contracts, in \$ / MWh, being excepted those Large Users (GU) that acquire the renewable energy by means of contracts with a generator, marketer or distributor (not CAMMESA) or by own generation.
- Those users that have one or multiple electric power demand points with independent meters are all registered, all registered with the same CUIT in the MEM or with the distributors, if in the sum of all the demand points they reach or exceed 300 kW of average power contracted in the calendar year, even if, in all or some of the demand points considered individually, they do not reach this value. The obligation governs as a percentage (%) of the total sum of their consumption.
- Only security and quality charges will be incorporated to the renewable's energy price. The price will not incorporate transitory cost of dispatch (STD), additional transitory cost of dispatch (ad STD), cost of fuel (SC), etc.
- Can be met through: Individual contracting, self-generation or Cogeneration of renewable sources.
- Prior to December 31, 2017, users must certify the subscription of the auto / cogeneration contracts or projects. At the moment of the verification of the fulfillment of the objectives of the Law, there will be penalties for missing energy, but no further details are established.
- The price will be established by CAMMESA as prorated by the total amount of the contracts and is reached by the price limit set in the Law (113 US\$ / MWh).
- **Resolution 281-E/2017:** this Resolution issued in August 2017 regulates the Renewable Energy Term Market (MATER) for MEM Large Users, setting forth the guidelines for self-generation and the agreements for the purchase of electric energy from renewable sources; the Resolution applies to Large Users with an average annual demand per connection point above 300 kW, and to generators, co-generators and self-generators entering the MEM as from January 2017.

The Forward Market regulation sets forth the following noteworthy provisions:

- It establishes dispatch priorities and an allocation mechanism.
- It creates commercialization and administration positions for Large Users intending to participate in CAMMESA's joint purchase scheme.
- It sets forth that Large Users opting out of CAMMESA's joint purchase scheme:
  - shall be subject to monitoring of their compliance with Law No. 27,191.
  - shall no longer pay for the renewable source generation acquired by CAMMESA.
  - shall no longer pay for Commercialization and Administration charges.
  - shall be entitled to discounts in capacity charges.
- No reserve power capacity is required for power purchase agreements executed within this scheme.
- It defines that the exclusion of joint purchases will have a minimum term of 5 years from the date the exclusion was declared.
- Allows the entitlement of renewable contracts to base or surplus demand.
- Defines that transport charges and those of primary frequency regulation will be recognized and absorbed by CAMMESA.
- It establishes the methodology for monitoring compliance and the imposition of penalties for breach, based on Gas Oil generation costs.



**YPF ENERGÍA ELÉCTRICA SOCIEDAD ANÓNIMA**  
**NOTES TO THE CONSOLIDATED FINANCIAL STATEMENTS**  
**AS OF DECEMBER 31, 2018 AND COMPARATIVE INFORMATION**

(Amounts expressed in thousands of Argentine Pesos, except as otherwise indicated)

**24.2. Regulatory framework of the Oil and Gas industry in Argentina**

Oil & gas exploration, exploitation and production activities in the Ramos area are regulated by the general framework of Law No. 17,319 (modified by Law No. 26,197) which establishes, among other matters, that oil deposits hydrocarbons located in the territory of the Argentine Republic belong to the provinces while those located on its continental shelf belong to the Federal government. This regulatory framework has been modified by Law No. 27,007 promulgated on October 30, 2014, which, among other modifications, established new terms for concessions for unconventional exploitation of hydrocarbons and for exploitation concessions on the continental shelf and in the territorial sea; new guidelines for the extension of exploitation concessions and a new Investment Promotion Regime for the Exploitation of Hydrocarbons aimed at projects that involve the realization of a direct investment in foreign currency of not less than US\$ 250 million.

In addition, this general legal framework is complemented by several resolutions and regulations from different jurisdictions that significantly affect the aforementioned oil and gas production operation.

On February 2, 2018, the Group sold to YPF its Oil & Gas business assets. Additionally see Note 3.a.

**24.3. Other Regulations**

– **CNV Regulatory Framework (N.T. 2013)**

By Resolution No. 622/2013 issued on September 5, 2013, the CNV approved the RULES (N.T. 2013) applicable to companies that are subject to CNV's control, pursuant to the provisions of the Capital Markets Law No. 26,831, and Regulatory Decree No. 1,023 dated August 1, 2013. This Resolution overrides previous CNV rules (N.T. 2001 as amended) and General Resolutions No. 615/2013 and No. 621/2013, as from the effective date of the RULES (N.T. 2013).

In accordance with section 1, Chapter III, Title IV of the General Resolution, the notes to the consolidated financial statements For the year ended December, 2018, disclosing the information required by the Resolution in the form of Exhibits, are detailed below.

Exhibit A – Fixed Assets	Note 7 Property, plant and equipment
Exhibit C – Investments in shares	Note 8 Investments in associates and joint ventures
Exhibit D – Other Investments	Note 5 Financial instruments by category
Exhibit E - Provisions	Note 9 Other receivables
Exhibit G – Assets and liabilities in foreign currency	Note 22 Information required by article 63 of Law No. 19,550 - Assets and liabilities in currencies other than peso

**25. TAX REFORM**

Laws No. 27,430 and 27,432 were published in the Official Gazette on December 29, 2017, and significantly modified several taxes. The main modifications are the following:

– **Income Tax**

• **Corporate tax rate and withholdings on dividends**

The general income tax rate applicable to corporations is reduced from 35% to 30% for fiscal years on or after beginning January 1, 2018 and ending December 31, 2019 inclusive, and to 25% for those fiscal years beginning on or after January 1, 2020 onwards.

Moreover, a new withholding on dividends is established for foreign individuals and beneficiaries, which will be 7% for those fiscal years beginning on or after January 1, 2018 and ending on December 31, 2019, and 13% for those fiscal years beginning on or after January 1, 2020 onwards.

Finally, the tax equalization (a 35% withholding is applicable when dividends exceed the amount of the taxable income) is no longer applied on the income accrued as of January 1, 2018.

• **Special tax – Tax Revaluation under Law No. 27,430**

Law No. 27,430 establishes that a tax revaluation of property, plant and equipment, may be made according to the mechanisms provided therein.

**YPF ENERGÍA ELÉCTRICA SOCIEDAD ANÓNIMA**  
**NOTES TO THE CONSOLIDATED FINANCIAL STATEMENTS**  
**AS OF DECEMBER 31, 2018 AND COMPARATIVE INFORMATION**

(Amounts expressed in thousands of Argentine Pesos, except as otherwise indicated)

Decree No. 353/2018, published in the Official Gazette on April 23, 2018, regulated Title X of Law No. 27,430 and established that the option referred to in article 281 of such Law could be exercised until the last business day of the sixth calendar month immediately following December 31, 2017.

Later, maturity dates were extended by Decree No. 613/2018 and Resolution No. 4249/2018, which established the last business day of the thirteenth month following the closing of fiscal year 2017 as the new deadline to exercise such option. Under this context, the new maturity date applicable to the Company is March 31, 2019.

The Company implemented the tax revaluation in the financial statements for fiscal year ended December 31, 2018, and recorded the cost of such option in the item "Special tax – Tax revaluation under Law No. 27,430" of the income tax charge for the fiscal year.

- **Capital gains for foreign beneficiaries**

The new law establishes a 15% withholding on capital gains derived from the sale of shares or other similar securities (calculated on the actual or presumed gains equivalent to 90% of the sale price). The law establishes an exemption applicable to foreign beneficiaries who sell listed shares under the supervision of the CNV. Furthermore, an exemption is established for the interest and sale results of government bonds, NO and ADRs. These exemptions will only apply to non-resident foreign beneficiaries whose funds do not derive from non-cooperating jurisdictions. Finally, such exemption does not apply to those benefits derived from the securities known as Lebac.

In the case of ADRs, the law defines that the source thereof is given by the residence of the issuer of the respective shares.

- **Indirect transfers made by the Foreign Beneficiaries**

The law establishes a tax on the indirect sale of assets located in Argentina. In particular, such tax will be levied on sales or transfers made by foreigners who own a company also abroad who owns assets in the country, when such assets are significant, i.e., when the following conditions are met: (i) at least 30% of the value of the shares in the foreign company derives from assets located in Argentina; and (ii) the transferred shares represent at least 10% of the assets of the foreign company.

The applicable rate will be 15% (calculated on real net profit or presumed net profit equivalent to 90% of the sale price) in the proportion corresponding to Argentine assets.

- **Other modifications**

It replaces the tax transparency rules contemplating broader situations and introduces the presumed dividend concept.

Moreover, it ratifies the taxability of the sales of shares of Argentine companies made by non-residents as of the effectiveness of Law No. 26,983, although it establishes the taxation of results in the cases of sales made through stock exchanges or similar markets, when the stockbroker did not withhold the tax.

- **Tax on bank debit and credits**

The PEN may fix the tax percentage to be computed as payment on account of the income tax, which will be progressively increased by up to 20% per year as of January 1, 2018, and it may also establish that this tax will be fully computed as payment on account of the income tax in 2022.

- **Value added tax**

A system of refund of tax paid for investments in property, plant and equipment is established, subject to the future generation of tax debits, in order to reduce the financial cost generated by the accumulation of tax credits of new investments.

- **Social Security**

There will be a minimum monthly salary exempt from employer contributions, while the rate of the same will be unified around 19.5%, although VAT tax credits will be eliminated for employment in secondary areas. These changes will occur by 2022, gradually converging from the current situation.

Other than as mentioned in Note 12 with respect to income tax, the mentioned modifications do not have a significant effect on the financial statements of the Group.

**YPF ENERGÍA ELÉCTRICA SOCIEDAD ANÓNIMA**  
**NOTES TO THE CONSOLIDATED FINANCIAL STATEMENTS**  
**AS OF DECEMBER 31, 2018 AND COMPARATIVE INFORMATION**

(Amounts expressed in thousands of Argentine Pesos, except as otherwise indicated)

**26. INFORMATION ON RELATED PARTIES**

The following table provides the accounts payable to/receivable from related parties as of December 31, 2018 and 2017 and January 1, 2017:

		Trade receivables	Other current receivables	Other non- current receivables	Accounts payable	Current loans	Non-current loans	Other current liabilities	Other non- current liabilities
<b>Joint controlling shareholder:</b>									
YPF S.A.	12.31.2018	1,758,720	-	-	1,819,452	-	-	-	-
	12.31.2017	43,449	-	-	267,069	377,087	-	-	-
	01.01.2017	19,917	-	-	92,879	7,243	739,680	-	-
GE EFS Power Investment B.V.	12.31.2018	-	5,250,000	-	-	-	-	-	-
	12.31.2017	-	-	-	-	-	-	-	-
	01.01.2017	-	-	-	-	-	-	-	-
<b>Associates:</b>									
Y-GEN Eléctrica III S.R.L.	12.31.2018	-	-	-	-	-	-	-	-
	12.31.2017	-	-	-	-	-	-	50	-
	01.01.2017	-	-	-	-	-	-	-	50
Y-GEN Eléctrica IV S.R.L.	12.31.2018	-	-	-	-	-	-	-	-
	12.31.2017	-	-	-	-	-	-	50	-
	01.01.2017	-	-	-	-	-	-	-	50
Refinería del Norte S.A.	12.31.2018	25,558	-	-	-	-	-	-	-
	12.31.2017	41,963	-	-	-	-	-	-	-
	01.01.2017	39,158	-	-	-	-	-	-	-
Metroenergía S.A.	12.31.2018	2,892	-	-	-	-	-	-	-
	12.31.2017	7,072	-	-	-	-	-	-	-
	01.01.2017	21,953	-	-	-	-	-	-	-
A-Evangelista S.A.	12.31.2018	-	-	-	342,895	-	-	-	-
	12.31.2017	-	-	-	1,140	-	-	-	-
	01.01.2017	-	-	-	8,216	-	-	-	-
Bajo del Toro II S.R.L.	12.31.2018	-	-	-	-	-	-	-	-
	12.31.2017	-	-	-	-	565,206	-	-	-
	01.01.2017	-	-	-	-	-	-	-	-
U.T. Loma Campana	12.31.2018	38,290	-	-	-	-	-	-	-
	12.31.2017	14,178	-	-	-	-	-	-	-
	01.01.2017	-	-	-	-	-	-	-	-
General Electric International INC.	12.31.2018	-	-	-	3,067	-	-	-	-
	12.31.2017	-	-	-	-	-	-	-	-
	01.01.2017	-	-	-	-	-	-	-	-
GE Global Parts and Products GmbH	12.31.2018	-	-	-	822,572	-	-	-	-
	12.31.2017	-	-	-	-	-	-	-	-
	01.01.2017	-	-	-	-	-	-	-	-
Profertil S.A.	12.31.2018	11,138	-	-	-	-	-	-	-
	12.31.2017	-	-	-	-	-	-	-	-
	01.01.2017	-	-	-	-	-	-	-	-

**YPF ENERGÍA ELÉCTRICA SOCIEDAD ANÓNIMA**  
**NOTES TO THE CONSOLIDATED FINANCIAL STATEMENTS**  
**AS OF DECEMBER 31, 2018 AND COMPARATIVE INFORMATION**

(Amounts expressed in thousands of Argentine Pesos, except as otherwise indicated)

		Trade receivables	Other current receivables	Other non- current receivables	Accounts payable	Current loans	Non-current loans	Other current liabilities	Other non- current liabilities
GE Water & Process Technologies SC	12.31.2018	-	-	-	6,502	-	-	-	-
	12.31.2017	-	-	-	-	-	-	-	-
	01.01.2017	-	-	-	-	-	-	-	-
GE Sensing & Inspection Technologies	12.31.2018	-	-	-	397	-	-	-	-
	12.31.2017	-	-	-	-	-	-	-	-
	01.01.2017	-	-	-	-	-	-	-	-
GE Energy Parts Inc.	12.31.2018	-	-	-	753	-	-	-	-
	12.31.2017	-	-	-	-	-	-	-	-
	01.01.2017	-	-	-	-	-	-	-	-
GE Packaged Power Inc.	12.31.2018	-	-	-	18,750	-	-	-	-
	12.31.2017	-	-	-	-	-	-	-	-
	01.01.2017	-	-	-	-	-	-	-	-
GE International Inc. Sucursal Argentina	12.31.2018	-	-	-	615,538	-	-	-	-
	12.31.2017	-	-	-	-	-	-	-	-
	01.01.2017	-	-	-	-	-	-	-	-
GE Intelligent Platforms	12.31.2018	-	-	-	367	-	-	-	-
	12.31.2017	-	-	-	-	-	-	-	-
	01.01.2017	-	-	-	-	-	-	-	-
GE Jenbacher GMBH & CO OG	12.31.2018	-	-	-	683	-	-	-	-
	12.31.2017	-	-	-	-	-	-	-	-
	01.01.2017	-	-	-	-	-	-	-	-
YPF Tecnología S.A.	12.31.2018	-	-	-	406	-	-	-	-
	12.31.2017	-	-	-	-	-	-	-	-
	01.01.2017	-	-	-	-	-	-	-	-
<b>Argentine federal government controlled entities:</b>									
CAMMESA	12.31.2018	1,816,331	124,731	452,881	-	-	-	-	-
	12.31.2017	426,833	90,345	452,881	-	-	-	-	-
	01.01.2017	250,131	128,913	513,854	-	-	-	-	-
<b>Subsidiaries:</b>									
Y-GEN Eléctrica S.A.U. <sup>(1)</sup>	12.31.2018	-	-	-	-	-	-	-	-
	12.31.2017	-	51,366	-	-	-	-	50	-
	01.01.2017	-	-	-	-	-	-	-	50
Y-GEN II Eléctrica S.A.U. (1)	12.31.2018	-	-	-	-	-	-	-	-
	12.31.2017	-	16,964	-	-	-	-	50	-
	01.01.2017	-	10,075	-	-	-	-	-	50
<b>Total</b>	12.31.2018	<b>3,652,929</b>	<b>5,374,731</b>	<b>452,881</b>	<b>3,631,382</b>	<b>-</b>	<b>-</b>	<b>-</b>	<b>-</b>
	12.31.2017	<b>533,495</b>	<b>158,675</b>	<b>452,881</b>	<b>268,209</b>	<b>942,293</b>	<b>-</b>	<b>200</b>	<b>-</b>
	01.01.2017	<b>331,159</b>	<b>138,988</b>	<b>513,854</b>	<b>101,095</b>	<b>7,243</b>	<b>739,680</b>	<b>-</b>	<b>200</b>

(1) Companies consolidated since March 31, 2018, see Note 3.b).

**YPF ENERGÍA ELÉCTRICA SOCIEDAD ANÓNIMA**  
**NOTES TO THE CONSOLIDATED FINANCIAL STATEMENTS**  
**AS OF DECEMBER 31, 2018 AND COMPARATIVE INFORMATION**

(Amounts expressed in thousands of Argentine Pesos, except as otherwise indicated)

The following table provides the transactions performed for the years ended December 31, 2018, and 2017 with related parties:

		<u>Sales</u>	<u>Purchases</u>	<u>Interest gain (loss)</u>
<b>Joint controlling shareholders of the group:</b>				
YPF S.A.	12.31.2018	1,119,111 <sup>(2)</sup>	174,271 <sup>(2) (3)</sup>	(8,896)
	12.31.2017	19,448	139,420	(49,001)
<b>Associates:</b>				
A-Evangelista S.A.	12.31.2018	-	893,579	-
	12.31.2017	-	5,351	-
U.T. Loma Campana	12.31.2018	69,922	-	-
	12.31.2017	11,717	-	-
General Electric International Inc. Sucursal Argentina	12.31.2018	-	1,648	-
	12.31.2017	-	-	-
GE Global Parts and Products GmbH	12.31.2018	-	3,108,319	-
	12.31.2017	-	-	-
GE Packaged Power Inc.	12.31.2018	-	185,783	-
	12.31.2017	-	-	-
GE Sensing & Inspection Technologies	12.31.2018	-	1,756	-
	12.31.2017	-	-	-
GE Water & Process Technologies SC	12.31.2018	-	20,950	-
	12.31.2017	-	-	-
General Electric International Inc. Suc. Argentina	12.31.2018	-	1,135,369	-
	12.31.2017	-	-	-
YPF Tecnología S.A.	12.31.2018	-	417	-
	12.31.2017	-	-	-
GE Intelligent Platforms	12.31.2018	-	367	-
	12.31.2017	-	-	-
GE Wind Energy Equipment	12.31.2018	-	558,074	-
	12.31.2017	-	-	-
GE Energy Parts Inc.	12.31.2018	-	753	-
	12.31.2017	-	-	-
GE Jenbacher GMBH & CO OG	12.31.2018	-	683	-
	12.31.2017	-	-	-
Profertil S.A.	12.31.2018	8,979	-	-
	12.31.2017	-	-	-
Bajo del Toro II S.R.L.	12.31.2018	-	-	(37,262)
	12.31.2017	-	-	(15,472)
<b>Argentine federal government controlled entities:</b>				
CAMMESA	12.31.2018	5,881,414	128,426	37,028
	12.31.2017	1,363,882	54,696	88,520
<b>Subsidiaries:</b>				
Y-GEN Eléctrica S.A.U. <sup>(1)</sup>	12.31.2018	10,209 <sup>(4)</sup>	-	-
	12.31.2017	37,325	-	-
Y-GEN Eléctrica II S.A.U. <sup>(1)</sup>	12.31.2018	10,549 <sup>(5)</sup>	-	-
	12.31.2017	38,298	-	-
<b>Total</b>	12.31.2018	<u><u>7,100,184</u></u>	<u><u>6,210,395</u></u>	<u><u>(9,130)</u></u>
	12.31.2017	<u><u>1,470,670</u></u>	<u><u>199,467</u></u>	<u><u>24,047</u></u>

(1) Companies controlled since March 31, 2018 (Note 3.b)).

(2) Does not include 438,799 and 1,580,664 related to re-sale of gas purchases, respectively.

(3) Includes 27,899 related to reimbursement of personnel costs.

(4) Does not include 4,117 and 34,720 for re-invoicing by contracted personnel for the years 2018, and 2017, respectively.

(5) Does not include 2,576 and 1,692 for re-invoicing by contracted personnel for the years 2018, and 2017, respectively.

Regarding the business of generation and sale of electricity, the Company's main customer is CAMMESA, an entity controlled by National Government. Taking into consideration that National Government is also YPF's controlling shareholder, CAMMESA is considered a related party.

For the year ended December 31, 2018, the Company performed transactions from discontinued operations with Refinería del Norte S.A. and CAMMESA for 5,617 and 35,885 respectively.

**YPF ENERGÍA ELÉCTRICA SOCIEDAD ANÓNIMA**  
**NOTES TO THE CONSOLIDATED FINANCIAL STATEMENTS**  
**AS OF DECEMBER 31, 2018 AND COMPARATIVE INFORMATION**

(Amounts expressed in thousands of Argentine Pesos, except as otherwise indicated)

For the year ended December 31, 2017, the Company performed transactions from discontinued operations with Refinería del Norte S.A., Metroenergía S.A. and CAMMESA for 54,356, 26,400 and 143,755, respectively.

**Remuneration of the Administration**

During the year ended December 31, 2018, the Director's fees and the remuneration to key executives amounted to 88,404, being the same short-term benefits and the only benefits granted to directors and key executives.

**27. SUBSEQUENT EVENTS**

Last March 20, 2019, GE Global Parts and Products GmbH informed the Company that the vessel in which part of the equipment that was being transported for the project to close the cycle of El Bracho thermal power plant, located in the province of Tucumán, suffered an incident and subsequent sinking, and as a consequence thereof the equipment that was being transported was lost. This event is being analyzed by the Company to determine the implications that may have with respect to the fulfilment of its obligations and the measures that can be adopted to minimize any negative impact. These assets were insured under an insurance policy contracted by our supplier and the claim was already reported to the insurer.

As of the date of issuance of these consolidated financial statements, there have not been other subsequent events whose effect on the financial position or results of operations as of December 31, 2018, or its exposure in a note to these consolidated financial statements, if corresponds, have not been considered in them according to IFRS.

MARCOS MIGUEL BROWNE  
President



**YPF ENERGÍA ELÉCTRICA S.A.  
CONDENSED INTERIM CONSOLIDATED  
FINANCIAL STATEMENTS AS OF MARCH 31, 2019  
AND COMPARATIVE INFORMATION (UNAUDITED)**

|

INDEX

Note	Description	Page
	Glossary of terms .....	
	Legal Information.....	1
	Condensed interim consolidated statements of financial position.....	2
	Condensed interim consolidated statements of comprehensive income .....	3
	Condensed interim consolidated statements of changes in shareholders' equity.....	4
	Condensed interim consolidated statements of cash flow.....	6
	Notes to the condensed interim consolidated financial statements:	
1	General information, structure and organization of the business of the Group.....	7
2	Basis of preparation of the condensed interim consolidated financial statements.....	8
3	Seasonality of operations.....	11
4	Acquisitions and dispositions.....	11
5	Financial risk management .....	11
6	Segment information.....	11
7	Financial instruments by category.....	11
8	Intangible assets.....	12
9	Property, plant and equipment .....	13
10	Right of use assets.....	14
11	Investments in associates and joint ventures.....	14
12	Other receivables .....	17
13	Trade receivables.....	17
14	Cash and cash equivalents.....	17
15	Income Tax.....	18
16	Leases liabilities.....	20
17	Loans.....	20
18	Accounts payable .....	21
19	Revenues.....	21
20	Expenses by nature .....	22
21	Discontinued operations – Ramos consortium.....	23
22	Net financial results.....	23
23	Shareholders' equity .....	23
24	Earnings per share.....	24
25	Restriction on retained earnings.....	24
26	Main contractual and guarantees granted .....	24
27	Contingent liabilities .....	24
28	Main regulations and others.....	25
29	Balances and transactions with related parties.....	27
30	Assets and liabilities in currencies other than peso.....	29
31	Subsequent events.....	29



**GLOSSARY OF TERMS**

Term	Definition
AFIP	Argentine Tax Authority
Associate	Company over which YPF EE has significant influence as provided for in IAS 28
CAMMESA	Compañía Administradora del Mercado Mayorista Eléctrico S.A.
CDS	Related Party Central Dock Sud S.A.
CNV	Argentine Securities Commission
GE	General Electric Corporation, Inc., or any of its subsidiaries and/or affiliates
GE EFS	GE EFS Power Investments B.V., an affiliate of GE
Group	YPF EE and its subsidiaries
IAS	International Accounting Standard
IASB	International Accounting Standards Board
IDS	Joint Venture Inversora Dock Sud S.A.
IFRIC	International Financial Reporting Standards Committee
IFRS	International Financial Reporting Standard
IGJ	Argentine Superintendence of Corporations
Joint Venture	Company jointly owned by YPF EE as provided for in IFRS 11
LGS	Argentine General Corporations Law No. 19,550 (T.O. 1984), as amended
Loma Campana I	Loma Campana I thermal power plant located in the district of Añelo, Province of Neuquén.
Loma Campana II	Loma Campana II thermal power plant located in the district of Añelo, Province of Neuquén.
MW	Megawatts
MWh	Megawatts per hour
NO	Negotiable Obligations
OPESSA	Related party and non controlling interest Operadora de Estaciones de Servicios S.A.
PPA	Capacity and/or power purchase agreements
SE	Secretariat of Energy
SEC	U.S. Securities and Exchange Commission
SEE	Secretariat of Energy Electric
Subsidiary	Company controlled by YPF EE in accordance with the provisions of IFRS 10.
US\$	U.S. dollar
Y-GEN	Subsidiary Y-GEN Eléctrica S.A.U. (previously Y- GEN ELECTRICA S.R.L.)
Y-GEN II	Subsidiary Y-GEN Eléctrica II S.A.U. (previously Y- GEN ELECTRICA II S.R.L.)
YPF	YPF Sociedad Anónima
YPF EE	YPF Energía Eléctrica S.A. or the Company
YPF EE Comercializadora	Subsidiary YPF EE Comercializadora S.A.U.

**YPF ENERGÍA ELÉCTRICA SOCIEDAD ANÓNIMA**  
**CONDENSED INTERIM CONSOLIDATED FINANCIAL STATEMENTS**  
**AS OF MARCH 31, 2019, AND COMPARATIVE INFORMATION (UNAUDITED)**



**LEGAL INFORMATION**

Legal address

111 Córdoba Av., 14th Floor – Buenos Aires – Argentina

Fiscal year

N° 7 beginning on January 1, 2019

Principal business of the Company

Generation, transport and commercialization of electric power from all kind of primary sources of production, and exploration and exploitation of oil and natural gas in the Ramos Area, province of Salta (operations related to Ramos Consortium constitute discontinued operations, see Note 3.a to the annual consolidated financial statements).

Tax identification code ("CUIT"): 30-71412830-9.

Registration date with the Public Commerce Registry:

- Of the articles of incorporation: August 26, 2013.
- Last amendment to bylaws: March 20, 2018

Registration with the IGJ: 16,440 of Book 65, Volume A of Corporations ("Sociedades Anónimas").

Duration of the company: Through August 26, 2112.

Capital Stock

(Amounts expressed in Argentine Pesos - See Note 23)

<u>Class of shares</u>	<u>Subscribed, paid-in, issued and registered</u>
Commons, book entry shares, with a nominal value of 1 each and entitled to one vote per share:	
Class A	2,810,302,991
Class B	936,767,364
	<u>3,747,070,355</u>

**YPF ENERGÍA ELÉCTRICA SOCIEDAD ANÓNIMA**  
**CONDENSED INTERIM CONSOLIDATED STATEMENTS OF FINANCIAL POSITION**  
**AS OF MARCH 31, 2019, AND DECEMBER 31, 2018 (UNAUDITED)**  
(Amounts expressed in thousands of Argentine Pesos)



	Notes	March 31, 2019	December 31, 2018
<b>ASSETS</b>			
<b>Non-current assets</b>			
Property, plant and equipment .....	9	48,503,937	37,650,465
Intangible assets .....	8	224,419	196,835
Right of use assets .....	10	527,130	-
Investments in associates and joint ventures .....	11	2,386,115	1,948,492
Other receivables .....	12	2,582,507	1,846,127
Investment in financial assets .....	7	41,571	69,901
Deferred income tax assets, net .....	15	36,029	54,153
<b>Total non-current assets .....</b>		<b>54,301,708</b>	<b>41,765,973</b>
<b>Current assets</b>			
Other receivables .....	12	1,626,910	6,234,304
Trade receivables .....	13	3,451,571	3,724,234
Other financial assets .....		1,750,466	1,489,031
Cash and cash equivalents .....	14	7,632,835	4,701,336
<b>Total current assets .....</b>		<b>14,461,782</b>	<b>16,148,905</b>
<b>TOTAL ASSETS .....</b>		<b>68,763,490</b>	<b>57,914,878</b>
<b>SHAREHOLDERS' EQUITY</b>			
Shareholders' contributions .....		8,411,982	8,411,982
Reserves, other comprehensive income and retained earnings .....		22,134,216	17,109,294
<b>TOTAL SHAREHOLDERS' EQUITY .....</b>		<b>30,546,198</b>	<b>25,521,276</b>
<b>LIABILITIES</b>			
<b>Non-current liabilities</b>			
Provisions .....		38,122	35,421
Deferred income tax liability .....	15	2,849,236	2,430,623
Leases liabilities .....	16	358,553	-
Loans .....	17	20,943,971	18,256,570
<b>Total non-current liabilities .....</b>		<b>24,189,882</b>	<b>20,722,614</b>
<b>Current liabilities</b>			
Taxes payable .....		281,960	340,436
Salaries and social security .....		136,040	151,256
Leases liabilities .....	16	100,748	-
Loans .....	17	6,809,814	6,514,408
Other liabilities .....		110,610	99,359
Accounts payable .....	18	6,588,238	4,565,529
<b>Total current liabilities .....</b>		<b>14,027,410</b>	<b>11,670,988</b>
<b>TOTAL LIABILITIES .....</b>		<b>38,217,292</b>	<b>32,393,602</b>
<b>TOTAL LIABILITIES AND SHAREHOLDERS' EQUITY .....</b>		<b>68,763,490</b>	<b>57,914,878</b>

Accompanying notes are an integral part of these condensed interim consolidated financial statements.

**YPF ENERGÍA ELÉCTRICA SOCIEDAD ANÓNIMA**  
**CONDENSED INTERIM CONSOLIDATED STATEMENTS OF COMPREHENSIVE INCOME**  
**FOR THE THREE-MONTH PERIOD ENDED MARCH 31, 2019 AND 2018 (UNAUDITED)**

**YPF LUZ**

(Amounts expressed in thousands of Argentine Pesos, except per share information, expressed in Argentine Pesos)

	Notes	For the three-month period ended March 31,	
		2019	2018
Revenues .....	19	2,691,682	644,389
Production costs .....	20	(892,818)	(233,720)
<b>Gross profit</b> .....		<b>1,798,864</b>	<b>410,669</b>
Administrative and selling expenses .....	20	(247,766)	(49,217)
Remeasurement of pre-existing equity interest .....		-	1,785,033
Other net operating results .....		33,838	(294)
<b>Operating profit</b> .....		<b>1,584,936</b>	<b>2,146,191</b>
Income from equity interest in associates .....	11	131,146	43,937
Finance income .....	21	515,756	269,750
Finance loss .....	21	(917,487)	(442,893)
Net financial results .....	21	(401,731)	(173,143)
<b>Profit before income tax from continuing operations</b> .....		<b>1,314,351</b>	<b>2,016,985</b>
Income tax .....	15	(197,080)	(113,147)
<b>Net profit for the period from continuing operations</b> .....		<b>1,117,271</b>	<b>1,903,838</b>
Profit after income tax for the period from discontinued operations .....	22	-	13,296
<b>Net profit for the period</b> .....		<b>1,117,271</b>	<b>1,917,134</b>
<b>Other comprehensive income for the period</b> .....			
<i>Items that may be reclassified to net income in subsequent periods</i>			
Fair value changes on derivatives instruments, net of tax effects <sup>(1)</sup> .....		(26,173)	24,810
<i>Items that may not be reclassified to net income in subsequent periods</i>			
Translation differences .....		3,933,824	332,988
<b>Net variation of other comprehensive income</b> .....		<b>3,907,651</b>	<b>357,798</b>
<b>Total comprehensive income for the period</b> .....		<b>5,024,922</b>	<b>2,274,932</b>
<b>Net income for the period attributable to shareholders</b>			
Continuing operations .....		1,117,271	1,903,838
Discontinued operations .....		-	13,296
<b>Total comprehensive income for the period attributable to shareholders</b>			
Continuing operations .....		5,024,922	2,261,636
Discontinued operations .....		-	13,296
<b>Basic and diluted earnings per share from continuing and discontinued operations:</b>			
Basic and diluted (Pesos) .....	24	0.298	0.665
<b>Basic and diluted earnings per share from continuing operations:</b>			
Basic and diluted (Pesos) .....	24	0.298	0.660

(1) Net of Income tax related to the period ended as of March 31, 2019 and March 31, 2018 for 9,100 and (8,627), respectively.

Accompanying notes are an integral part of these condensed interim consolidated financial statements.

**YPF ENERGÍA ELÉCTRICA SOCIEDAD ANÓNIMA**  
**CONDENSED INTERIM CONSOLIDATED STATEMENTS OF CHANGES IN SHAREHOLDERS' EQUITY**  
**FOR THE THREE-MONTH PERIOD ENDED MARCH 31, 2019 AND 2018 (UNAUDITED)**  
(Amounts expressed in thousands of Argentine Pesos)



	For the three-month period ended March 31, 2019							
	Shareholders' contributions	Reserves			Other comprehensive income	Retained earnings	Total	
	Subscribed capital	Share Premium	Other shareholders' contributions	Legal reserve	Voluntary reserves			
<b>As of January 1, 2019</b>	3,747,070	4,604,483	60,429	52,755	881,681	11,739,242	4,435,616 <sup>(1)</sup>	25,521,276
Other comprehensive income for the period	-	-	-	-	-	3,907,651	-	3,907,651
Net profit for the period	-	-	-	-	-	-	1,117,271	1,117,271
<b>As of March 31, 2019</b>	<b>3,747,070</b>	<b>4,604,483</b>	<b>60,429</b>	<b>52,755</b>	<b>881,681</b>	<b>15,646,893</b>	<b>5,552,887</b>	<b>30,546,198</b>

(1) Includes 11,532 corresponding to the initial adjustment for the implementation of IFRS, that was allocated to a special reserve by the shareholders' meeting held on May 7, 2019 that approved the financial statement as of December 31, 2018.

Accompanying notes are an integral part of these condensed interim consolidated financial statements.

MARCOS BROWNE  
President

**YPF ENERGÍA ELÉCTRICA SOCIEDAD ANÓNIMA**  
**CONDENSED INTERIM CONSOLIDATED STATEMENTS OF CHANGES IN SHAREHOLDERS' EQUITY**  
**FOR THE THREE-MONTH PERIOD ENDED MARCH 31, 2019 AND 2018 (UNAUDITED) (Cont.)**  
(Amounts expressed in thousands of Argentine Pesos)



	For the three-month period ended March 31, 2018							Total
	Shareholders' contributions		Reserves			Other comprehensive income	Retained earnings	
	Subscribed capital	Share Premium	Other shareholders' contributions	Legal reserve	Voluntary reserves			
<b>As of January 1, 2018</b>	2,506,556	-	-	6,351	-	542,191	858,289 <sup>(1)</sup>	3,913,387
As decided by the General Extraordinary Shareholders' Meeting of January 12, 2018								
- Capital increase	303,747	-	-	-	-	-	-	303,747
As decided by the General Ordinary and Extraordinary Shareholders' Meeting of March 20, 2018								
- Capital increase	936,767	-	-	-	-	-	-	936,767
- Contribution in share premium	-	4,604,483	-	-	-	-	-	4,604,483
Sale of Ramos Consortium and Central Dock Sud S.A. interests in (Note 3.a. to the annual consolidated financial statements)	-	-	60,429	-	-	-	-	60,429
Other comprehensive income for the period	-	-	-	-	-	357,798	-	357,798
Net profit for the period	-	-	-	-	-	-	1,917,134	1,917,134
<b>As of March 31, 2018</b>	<b>3,747,070</b>	<b>4,604,483</b>	<b>60,429</b>	<b>6,351</b>	<b>-</b>	<b>899,989</b>	<b>2,775,423</b>	<b>12,093,745</b>

(1) Includes 11,532 corresponding to the initial adjustment for the implementation of IFRS, that was allocated to a special reserve by the shareholders' meeting held on May 7, 2019 that approved the financial statement as of December 31, 2018.

Accompanying notes are an integral part of these condensed interim consolidated financial statements.

MARCOS BROWNE  
President

**YPF ENERGÍA ELÉCTRICA SOCIEDAD ANÓNIMA**  
**CONDENSED INTERIM CONSOLIDATED STATEMENTS OF CASH FLOW**  
**FOR THE THREE-MONTH PERIOD ENDED MARCH 31, 2019 AND 2018 (UNAUDITED)**  
(Amounts expressed in thousands of Argentine Pesos)

	<b>For the three-month period ended March 31,</b>	
	<b>2019</b>	<b>2018</b>
<b>OPERATING ACTIVITIES</b>		
Net profit for the period from continuing operations	1,117,271	1,903,838
Net profit for the period from discontinued operations	-	13,296
Net profit for the period	<u>1,117,271</u>	<u>1,917,134</u>
Adjustments to reconcile net profit to net cash flows from operating activities:		
Income from equity interest in associates	(131,146)	(43,937)
Remeasurement of pre - existing equity interest	-	(1,785,033)
Depreciation of property, plant and equipment	503,964	68,756
Depreciation of right of use assets	31,253	-
Decreases of property, plant and equipment	-	2,167
Net financial results	401,731	173,143
Movements in provisions	2,701	28,971
Charge on income tax	197,080	115,229
Increase in provision for doubtful trade receivables	48,772	-
Income tax payments	(26,162)	-
Changes in operating assets and liabilities:		
Trade receivables	603,725	(554,484)
Other receivables	(627,993)	(92,743)
Accounts payable	(358,244)	471,448
Salaries and social security	(15,215)	17,979
Taxes payable	(32,314)	74,893
<b>Net cash flows from operating activities</b>	<b><u>1,715,423</u></b>	<b><u>393,523</u></b>
<b>INVESTING ACTIVITIES</b>		
Acquisition of property, plant and equipment	(3,234,036)	(1,654,545)
Acquisition of interest in subsidiaries <sup>(1)</sup>	-	(1,453,542)
Advances to suppliers to property, plant and equipment	(849,999)	(6,071)
Other financial assets	(37,492)	-
Sales of interests in subsidiaries	-	283,247
Contributions in joint ventures	-	(4,076)
<b>Net cash flows used in investing activities</b>	<b><u>(4,121,527)</u></b>	<b><u>(2,834,987)</u></b>
<b>FINANCING ACTIVITIES</b>		
Proceeds for loans	-	2,125,003
Shareholders' contributions received	5,691,000	2,720,250
Payments of loans	(509,812)	(808,000)
Payments of leases liabilities	(27,984)	-
Payment of interest and other financial costs	(519,891)	(81,556)
<b>Net cash flows from financing activities</b>	<b><u>4,633,313</u></b>	<b><u>3,955,697</u></b>
<b>Net increase in cash and cash equivalents</b>	<b>2,227,209</b>	<b>1,514,233</b>
Effect of exchange difference variations on cash and cash equivalents	704,290	34,435
Cash and cash equivalents at the beginning of year	<u>4,701,336</u>	<u>139,082</u>
Cash and cash equivalents at the end of the period	<b><u>7,632,835</u></b>	<b><u>1,687,750</u></b>
<b>For the three-month period ended March 31,</b>		
	<b>2019</b>	<b>2018</b>
Acquisitions of property, plant and equipment pending to be cancelled at the beginning of the year	1,743,008	491,457
Acquisitions of property, plant and equipment pending to be cancelled at the end of the period	3,367,799	818,338
Transfer of advances for purchase of property, plant and equipment	416,184	150,225

(1) Net of cash and cash equivalents of 172,612, incorporated by business combination (See note3.b) to the annual consolidated financial statements).

Accompanying notes are an integral part of these condensed interim consolidated financial statements.

**YPF ENERGÍA ELÉCTRICA SOCIEDAD ANÓNIMA**  
**NOTES TO THE CONDENSED INTERIM CONSOLIDATED FINANCIAL STATEMENTS**  
**AS OF MARCH 31, 2019, AND COMPARATIVE INFORMATION (UNAUDITED)**

(Amounts expressed in thousands of Argentine Pesos, except as otherwise indicated)

**1. GENERAL INFORMATION, STRUCTURE AND ORGANIZATION OF THE BUSINESS OF THE GROUP**

General information

YPF Energía Eléctrica S.A. (hereinafter “the “Company” or “YPF EE”) is a Sociedad Anónima (Argentine business association type akin to a stock corporation) organized under the laws of Argentina. Its registered office is at 111 Córdoba Av., 14<sup>th</sup> Floor, Buenos Aires City.

YPF EE and the companies that make up the business Group are mainly engaged in (i) generating and selling electric power through three thermal generation plants located in the Province of Tucumán, two thermal generation plants and moto generators located in the Province of Neuquén, a cogeneration plant in the Province of Buenos Aires and a wind farm in the Province of Chubut (ii) building new thermal generation plants project in the Province of Tucumán and a cogeneration plant in La Plata; (iii) building wind farms in the Province of Santa Cruz and Buenos Aires; (iv) selling energy, (v) indirect participation through IDS in the generation and commercialization of electric energy through CDS thermal power plant; and (vi) exploring, exploiting, producing, transporting and/or storing liquid and gaseous hydrocarbons (discontinued operation, see Note 3.a) to the annual financial statements).

The Group has an installed capacity, at the date of issuance of these interim consolidated financial statements, of 1,819MW, representing approximately 6.6% of the maximum power and approximately 8.5% of the average energy demanded in Argentina, according to information published by CAMMESA.

Additionally, the Group has projects under construction with an installed capacity of more than 634MW.

The Group’s assets and generation projects portfolio are located in the provinces of Tucumán, Neuquén, Buenos Aires, Chubut and Santa Cruz.

Structure and organization of the economic group

The following chart shows the organizational structure, including the main companies of the Group, as of March 31, 2019:

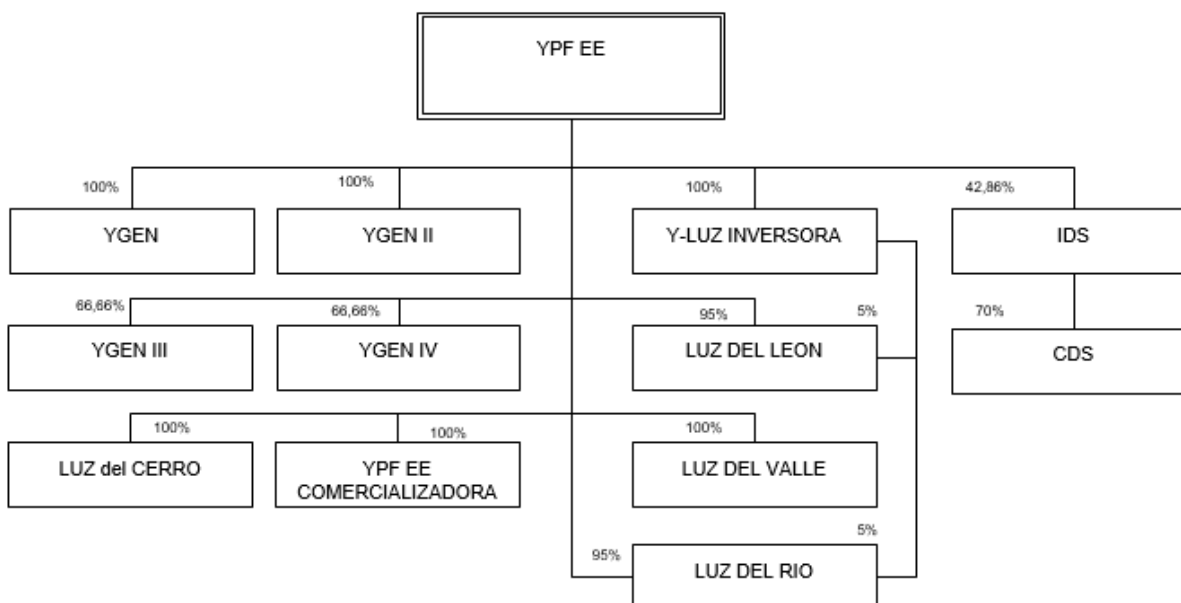



**YPF ENERGÍA ELÉCTRICA SOCIEDAD ANÓNIMA**  
**NOTES TO THE CONDENSED INTERIM CONSOLIDATED FINANCIAL STATEMENTS**  
**AS OF MARCH 31, 2019, AND COMPARATIVE INFORMATION (UNAUDITED)**  
(Amounts expressed in thousands of Argentine Pesos, except as otherwise indicated)



**2. BASIS OF PREPARATION OF THE CONDENSED INTERIM CONSOLIDATED FINANCIAL STATEMENTS**

**2.a) Basis of preparation**

The condensed interim consolidated financial statements of YPF EE for the three-month period ended March 31, 2019, are presented in accordance with IAS 34 "Interim Financial Reporting". These condensed interim consolidated financial statements should be read in conjunction with the annual consolidated financial statements of the Group as of December 31, 2018 prepared in accordance with IFRS as issued by IASB and interpretations issued by the IFRIC.

Likewise, additional disclosures required by the LGS and/or CNV regulations have been included with the only purposes of complying with such regulatory requirements.

These condensed interim consolidated financial statements were approved by the Board of Directors' meeting and authorized to be issued on May 8, 2019.

These condensed interim consolidated financial statements for the three-month period ended March 31, 2019 are unaudited. The Company's Management believes that they include all necessary adjustments to reasonably present the results of each period on a basis consistent with the audited annual consolidated financial statements. Net income for the three-month period ended on March 31, 2019 does not necessarily reflect the proportion of the Group's full-year income.

**2.b) Significant Accounting Policies**

The most significant accounting policies are described in Note 2.3 to the annual consolidated financial statements.

The accounting policies adopted for the preparation of these condensed interim consolidated financial statements are consistent with those used in the preparation of the annual consolidated financial statements. Likewise, as from January 1, 2019, the Group has applied the guidelines of the IFRS 16, "Leases". See detailed accounting policy below.

Functional and reporting currency

As mentioned in Note 2.3.1. to the annual consolidated financial statements, YPF EE has defined the U.S. dollar as its functional currency. Additionally, according to CNV Resolution No. 562, YPF EE must present its financial statements in Argentine pesos.

Adoption of new standards and interpretations effective as of January 1, 2019

The Group has adopted new and revised standards and interpretations, issued by the IASB, relevant to its operations application is effective as of March 31, 2019, as specified in Note 2.6 to the annual consolidated financial statements. The aforementioned new standards and interpretations that have had an effect on these condensed interim consolidated financial statements are described below:

MARCOS BROWNE  
President

**YPF ENERGÍA ELÉCTRICA SOCIEDAD ANÓNIMA**  
**NOTES TO THE CONDENSED INTERIM CONSOLIDATED FINANCIAL STATEMENTS**  
**AS OF MARCH 31, 2019, AND COMPARATIVE INFORMATION (UNAUDITED)**  
(Amounts expressed in thousands of Argentine Pesos, except as otherwise indicated)



**- IFRS 16 - Leases**

The model introduced by this standard is based on the definition of lease, which is mainly related to the concept of control. IFRS 16 distinguishes between lease agreements and service contracts based on whether an identified asset is under the client control, which exists as long as the customer has the right to: i) obtain substantially all the economic benefits from the use of the asset; and ii) to direct the use of that asset.

The Group as lessee:

Once the lease is identified, the Group recognizes the following items:

- Right of use assets, whose cost includes:
  - a. the amount of the initial measurement of the lease liability;
  - b. any lease payments made to the lessor prior to the start date or on the same date, after discounting any incentive received for the lease;
  - c. any initial direct costs incurred by the lessee; and
  - d. an estimate of costs to be incurred in dismantling and removing of the underlying asset, restoring the location in which the underlying asset is located or restoring the underlying asset to the condition required by the terms and conditions of the lease, unless incurred costs when producing inventories. The Group may incur obligations for these costs either at the beginning date or as a consequence of having used the underlying asset during a given period.

Subsequently, the valuation of the right of use assets will be based on the cost model or the revaluation model set in IAS 16 "Property, plant and equipment" (recognizing therefore depreciation and impairment in the profit and loss account and, in case of application of the revaluation model, those revaluations in equity). Depreciation is calculated following the straight-line method based on the lease term of each contract, unless the useful life of such underlying asset is shorter.

The lease agreements in which the Group is a lessee correspond mainly to the rental of:

- o Usufruct contracts for the land in which the Group is building its wind farms.  
These contracts have an average term of 17 years, with the option to renew for other 20 years, and do not have contingent canons.
- o Rental contracts for the Group administrative offices  
These contracts establish monthly payments and last three years.
- o Rental contracts for motor generator equipment  
These contracts have a 5 - year term with a purchase option at the end of the term. They do not have contingent canons.
- Lease liabilities, measured as the sum of the future lease payments, discounted using the incremental borrowing rate of the lessee given the complexity of determining the interest rate implicit in the leases. The Group applied to the lease liabilities recognized in the statement of financial position the incremental borrowing rate of the lessee since the date of initial application.

The lease liabilities include:

- a. fixed payments (including essentially fixed payments), less any lease incentive receivable;
- b. variable payments, which depend on an index or a rate, initially measured using the index or rate at the commencement date of the contract;
- c. amounts that the Group expects to pay as residual value guarantees;
- d. the exercise price of a purchase option if the Group is reasonably certain of exercising that option; and
- e. payment of penalties for terminating the lease, if the lease period reflects that the Group will exercise an option to terminate it (ie, because there is reasonable certainty in this respect).

MARCOS BROWNE  
President

**YPF ENERGÍA ELÉCTRICA SOCIEDAD ANÓNIMA**  
**NOTES TO THE CONDENSED INTERIM CONSOLIDATED FINANCIAL STATEMENTS**  
**AS OF MARCH 31, 2019, AND COMPARATIVE INFORMATION (UNAUDITED)**



(Amounts expressed in thousands of Argentine Pesos, except as otherwise indicated)

Subsequently, the Group increases the liability for the lease to reflect the accrued interest (and recognized in the statement of comprehensive income), deducts the payments that are paid from the liability and recalculates the book value to reflect any revision, modification of the lease or revision of the so-called "in substance" fixed payments, applying a revised discount rate if applicable.

The Group reviews the lease liability in the following cases:

- a. when there is a change in the expected amount to be paid under a residual value guarantee;
- b. when there is a change in future lease payments resulting from a change in an index or an interest rate used to determine those payments (including, for example, a market rent review);
- c. when there is a change in the lease term as a result of a change in the non-cancelable period of the lease (for example, if the lessee does not exercise an option previously included in the determination of the lease term); or
- d. when there is a change in the evaluation of the purchase option of the underlying asset.

The Group recognized right of use assets and lease liabilities of 206,006 as of January 1, 2019 in the statement of financial position, measured at the present value of future payments. In addition, the Group reclassified 282,278 from property, plant and equipment to right of use assets, and reclassified 210,166 from loans to lease liabilities.

The application of this standard had no effect on the accumulated results since the Group applied the simplified model without restating the comparative figures, recognizing a right of use asset equivalent to the lease liability on the initial date of transition (January 1, 2019). There were no adjustments to be made due to impairment arising from onerous contracts related to these right of use assets.

For leases that qualify as short-term leases, and leases with low-value underlying assets, the Group continues to recognize them as straight-line expense over the term of the lease, unless another systematic basis is more representative, in accordance with the option indicated by the rule. The group did not identify low value leases other than those whose underlying assets respond to printers, cell phones, computers, photocopiers, among them, which amounts are not significant.

The Group applied the practical solution of the rule by which those leases whose term ends within 12 months from the date of initial application, regardless of the original date, and fulfilling the conditions to be classified as short term, continue the treatment described in the previous paragraph.

#### The Group as a lessor

IFRS 16 requires the lessor to classify the lease as operating or financial. A financial lease is a lease in which all the risks and benefits derived from the ownership of the asset are substantially transferred. A lease will be classified as operating if it does not transfer substantially all the risks and rewards inherent in the ownership of an underlying asset.

The classification of the lease is made on the date of commencement of the agreement and is evaluated again only if there is a modification of the lease. Changes in estimates (for example, changes in economic life or in the carrying value of the underlying asset) or changes in circumstances (for example, default by the lessee) will not result in a new classification of the lease for accounting purposes.

The Group does not have significant assets leased to third parties.

#### **2.c) Accounting Estimates and Judgments**

The preparation of financial statements at a certain date requires Management to make estimates and assessments affecting the amount of assets and liabilities recorded, contingent assets and liabilities disclosed at such date, as well as income and expenses recorded during the period. Actual future results might differ from the estimates and assessments made as of the date of preparation of these condensed interim consolidated financial statements.

In preparing these condensed interim consolidated financial statements, significant estimates and judgments were made by Management in applying the Group's accounting policies and the main sources of uncertainty were consistent with those applied by the Group in the preparation of the annual consolidated financial statements, which are disclosed in Note 2.4 to the annual consolidated financial statements.

MARCOS BROWNE  
 President

**YPF ENERGÍA ELÉCTRICA SOCIEDAD ANÓNIMA**  
**NOTES TO THE CONDENSED INTERIM CONSOLIDATED FINANCIAL STATEMENTS**  
**AS OF MARCH 31, 2019, AND COMPARATIVE INFORMATION (UNAUDITED)**  
(Amounts expressed in thousands of Argentine Pesos, except as otherwise indicated)



## 2.d) Comparative information

Amounts and other information corresponding as of December 31, 2018 and to the three-month period ended March 31, 2018 are an integral part of these condensed interim consolidated financial statements and are intended to be read only in relation to these financial statements.

## 3. SEASONALITY OF OPERATIONS

The Company's revenue for the three-month period ended March 31, 2019 is not significantly affected by seasonal effects.

## 4. ACQUISITIONS AND DISPOSITIONS

During the three-month period ended March 31, 2019, there have been no acquisitions or dispositions. Details of the transactions carried out in 2018 are described in Note 3 to the annual consolidated financial statements.

## 5. FINANCIAL RISK MANAGEMENT

The Group's activities are exposed to a variety of financial risks: market risk (including foreign currency risk, interest rate risk and price risk), credit risk and liquidity risk. The Group maintains an organizational structure and systems that allow for the identification, measurement and adoption of the necessary actions in order to minimize the risks to which it is exposed.

The condensed interim consolidated financial statements do not include all the information and disclosures on financial risk management. Therefore, they should be read in conjunction with the Group's annual consolidated financial statements.

There have been no significant changes in risk management or risk management policies applied by the Group since the last fiscal year end. See Note 4 to the annual consolidated financial statements.

## 6. SEGMENT INFORMATION

For management purposes, the Group is organized as a single business segment to generate and sell electric energy. The Group discloses only the information about this activity in its operating profit on the consolidated statement of comprehensive income.

## 7. FINANCIAL INSTRUMENTS BY CATEGORY

### Fair value measurements

Fair value measurements are described in Note 5 to the annual consolidated financial statements.

The tables below show the Group's financial assets measured at fair value as of March 31, 2019 and December 31, 2018, and their allocation to fair value hierarchies:

Financial assets	As of March 31, 2019			Total
	Level 1	Level 2	Level 3	
Cash and Cash equivalents:				
- Mutual funds .....	6,326	-	-	6,326
Investments in financial assets:				
- Hedging Instruments .....	-	-	41,571	41,571
	<b>6,326</b>	<b>-</b>	<b>41,571</b>	<b>47,897</b>
Financial assets	As of December 31, 2018			Total
	Level 1	Level 2	Level 3	
Investments in financial assets:				
- Hedging Instruments .....	-	-	69,901	69,901
	<b>-</b>	<b>-</b>	<b>69,901</b>	<b>69,901</b>

The Group has no financial liabilities at fair value.

MARCOS BROWNE  
President

**YPF ENERGÍA ELÉCTRICA SOCIEDAD ANÓNIMA**  
**NOTES TO THE CONDENSED INTERIM CONSOLIDATED FINANCIAL STATEMENTS**  
**AS OF MARCH 31, 2019, AND COMPARATIVE INFORMATION (UNAUDITED)**  
(Amounts expressed in thousands of Argentine Pesos, except as otherwise indicated)



Fair value estimates

From December 31, 2018 until March 31, 2019, there have been no significant changes in the commercial or economic circumstances affecting the fair value of the Group's assets and financial liabilities, whether measured at fair value or amortized cost.

Furthermore, during the three-month period ended March 31, 2019, there were no transfers between the different hierarchies used to determine the fair value of the Group's financial instruments.

Fair value of financial assets and financial liabilities measured at amortized cost

The estimated fair value of loans, considering interest rates offered to the Group (Level 3) for its financial loans, amounted approximately to 27,231,986 and 24,569,978 as of March 31, 2019 and December 31, 2018, respectively.

The fair value of other receivables, trade receivables, cash and cash equivalents, accounts payable and other liabilities do not differ significantly from their book value.

**8. INTANGIBLE ASSETS**

Changes in the Group's intangible assets for the three-month period ended March 31, 2019 and the year ended December 31, 2018 are as follows:

	<u>Intangible assets</u>
<b>Balances as of December 31, 2017</b> .....	<u><u>-</u></u>
<u>Cost</u>	
Increases .....	143,385
Translation effect .....	53,450
Cost .....	196,835
Accumulated amortization .....	-
<b>Balances as of December 31, 2018</b> .....	<u><u>196,835</u></u>
<u>Cost</u>	
Translation effect .....	27,584
Cost .....	224,419
Accumulated amortization .....	-
<b>Balances as of March 31, 2019</b> .....	<u><u>224,419</u></u>

MARCOS BROWNE  
President

**YPF ENERGÍA ELÉCTRICA SOCIEDAD ANÓNIMA**  
**NOTES TO THE CONDENSED INTERIM CONSOLIDATED FINANCIAL STATEMENTS**  
**AS OF MARCH 31, 2019, AND COMPARATIVE INFORMATION (UNAUDITED)**  
(Amounts expressed in thousands of Argentine Pesos, except as otherwise indicated)



**9. PROPERTY, PLANT AND EQUIPMENT**

Changes in Group's property, plant and equipment for the three-month period ended March 31, 2019 and the year ended December 31, 2018 are as follows:

	Land and buildings	Mineral property, wells and related equipment <sup>(3)</sup>	Production facilities, machinery, equipment and spare parts of power plants	Transportation equipment	Materials and equipment in ware house	Work in progress	Furniture, fixtures, computer and communication equipment	Total
<b>Cost:</b>								
Increases	28,667	395,476	4,051,063	10,446	205,092	2,388,215	10,295	7,089,254
Accumulated depreciation	3,701	336,576	1,503,638	4,698	-	-	5,918	1,854,531
<b>Balances as of December 31, 2017</b>	<b>24,966</b>	<b>59,900</b>	<b>2,547,425</b>	<b>5,748</b>	<b>205,092</b>	<b>2,388,215</b>	<b>4,377</b>	<b>5,234,723</b>
<b>Cost:</b>								
Increases	-	-	708,481	8,090	736,145	8,410,746	14,548	9,878,010
Business combination	-	-	8,664,782	-	-	-	-	8,664,782
Translation effect	30,011	-	11,777,620	9,601	321,773	4,972,124	9,505	17,120,634
Transfers	220	2,583	8,219,391	-	-	(8,222,194)	-	-
Disposals	(764)	(386,059)	-	(1,662)	(49,572)	(19,316)	(1,350)	(470,723)
<b>Accumulated depreciation</b>								
Increases	1,054	3,407	1,275,173	2,424	-	-	1,216	1,283,274
Translation effect	3,474	-	1,822,951	4,219	-	-	5,646	1,836,290
Disposals	(636)	(339,983)	-	(1,320)	-	-	(664)	(342,603)
<b>Cost:</b>								
Increases	58,134	-	33,421,337	26,475	1,213,438	7,529,575	32,998	42,281,957
Accumulated depreciation	7,593	-	4,601,762	10,021	-	-	12,116	4,631,492
<b>Balances as of December 31, 2018</b>	<b>50,541</b>	<b>-</b>	<b>28,819,575</b>	<b>16,454</b>	<b>1,213,438</b>	<b>7,529,575</b>	<b>20,882</b>	<b>37,650,465</b>
<b>Cost:</b>								
Increases	-	-	22,039	11,877	48,695	5,367,574	-	5,450,185
Translation effect	8,736	-	5,133,519	5,101	275,513	1,540,191	4,959	6,989,019
Transfers and reclassifications	-	-	(251,875)	-	38,267	(68,670)	-	(282,278)
Disposals	-	-	-	-	-	-	-	-
<b>Accumulated depreciation</b>								
Increases	389	-	501,477	1,480	-	-	618	503,964
Translation effect	1,182	-	773,761	1,661	-	-	1,886	778,490
<b>Cost:</b>								
Increases	66,870	-	38,325,020	43,453	1,575,913	14,368,670	37,957	54,417,863
Accumulated depreciation	9,164	-	5,877,000	13,162	-	-	14,620	5,913,946
<b>Balances as of March 31, 2019</b>	<b>57,706</b>	<b>-</b>	<b>32,448,020</b>	<b>30,291</b>	<b>1,575,913</b>	<b>14,368,670</b>	<b>23,337</b>	<b>48,503,937</b>

(1) Depreciation has been calculated using the unit-of-production method (Note 2.3.2. to the annual consolidated financial statements). Corresponds to discontinued operations.

(2) Includes 174 and 577,636 of financial cost related to financing from third parties for extended works in progress for the period ended March 31, 2019 and the year ended December 31, 2018, respectively.

(3) Corresponds to mineral property, plant and equipment reclassified to Right of Use Assets.

(4) Corresponds to machinery and equipment reclassified to Right of Use Assets. (See Note 10).

MARCOS BROWNE  
President

**YPF ENERGÍA ELÉCTRICA SOCIEDAD ANÓNIMA**  
**NOTES TO THE CONDENSED INTERIM CONSOLIDATED FINANCIAL STATEMENTS**  
**AS OF MARCH 31, 2019, AND COMPARATIVE INFORMATION (UNAUDITED)**  
(Amounts expressed in thousands of Argentine Pesos, except as otherwise indicated)

**YPF LUZ**

**10. RIGHT OF USE ASSETS**

Changes in Group's right of use assets for the three-month period ended March 31, 2019 are as follows:

	<u>Buildings</u>	<u>Land</u>	<u>Machinery and equipment</u>	<u>Total</u>
<b>Balances as of December 31, 2018</b> .....	-	-	-	-
<u>Cost</u>				
Increases .....	56,313	149,693	-	206,006
Translation effect .....	8,462	22,494	42,417	73,373
Reclassifications <sup>(1)</sup> .....	-	-	282,278	282,278
<u>Accumulated depreciation</u>				
Increases .....	5,497	609	25,147	31,253
Translation effect .....	577	63	2,634	3,274
Cost .....	64,775	172,187	324,695	561,657
Accumulated depreciation .....	6,074	672	27,781	34,527
<b>Balances as of March 31, 2019</b> .....	<b>58,701</b>	<b>171,515</b>	<b>296,914</b>	<b>527,130</b>

(1) Reclassifications from Property, plant and equipment, according to IFRS 16.

**11. INVESTMENTS IN ASSOCIATES AND JOINT VENTURES**

The following table shows the value of the investments in associates and joint ventures at an aggregate level, as of March 31, 2019 and December 31, 2018:

	<u>March 31, 2019</u>	<u>December 31, 2018</u>
Amount of investments in associates and joint ventures .....	2,386,115	1,948,390
<b>Total</b> .....	<b>2,386,115</b>	<b>1,948,390</b>
Disclosed in Investment in associates and Joint ventures	2,386,115	1,948,492
Disclosed in Accounts payable – YPF EE Comercializadora S.A.U.	-	(102)

The main movements during the three-month period ended March 31, 2019 and for the year ended December 31, 2018, which affected the value of the aforementioned investments, correspond to:

	<u>Investments in associates and joint ventures</u>
<b>Amount as of December 31, 2017</b> .....	<b>2,424,677</b>
Shareholders' contributions .....	4,076
Income on investments in associates and joint ventures .....	292,825
Translation differences .....	1,026,147
Dividends distribution .....	(53,996)
Decrease due to acquisition of control .....	(1,439,691) <sup>(1)</sup>
Dispositions .....	(305,648)
<b>Amount as of December 31, 2018</b> .....	<b>1,948,390</b>
Income on investments in associates and joint ventures .....	131,146
Translation differences .....	306,579
<b>Amount as of March 31, 2019</b> .....	<b>2,386,115</b>

(1) See Note 3.b to the annual consolidated financial statements.

MARCOS BROWNE  
President

**YPF ENERGÍA ELÉCTRICA SOCIEDAD ANÓNIMA**  
**NOTES TO THE CONDENSED INTERIM CONSOLIDATED FINANCIAL STATEMENTS**  
**AS OF MARCH 31, 2019, AND COMPARATIVE INFORMATION (UNAUDITED)**



(Amounts expressed in thousands of Argentine Pesos, except as otherwise indicated)

The following table shows the principal amounts of the results of the investments in associates and joint ventures of the Group, calculated according to the equity method therein, for the three-month period ended March 31, 2019 and 2018. The Group has adjusted, if applicable, the figures reported by these companies to adapt them to the accounting principles used by the Group for the calculation of the equity method as of the abovementioned dates:

	<b>Associates and Joint Ventures</b>	
	<b>for the three-month period ended March 31,</b>	
	<b>2019</b>	<b>2018</b>
Net income .....	131,146	43,937
Other comprehensive income – Fair value changes on derivatives instruments .....	-	24,810
Comprehensive income for the period .....	131,146	68,747
Translation differences .....	306,477	185,172
<b>Total comprehensive income for the period .....</b>	<b>437,623</b>	<b>253,919</b>

The Group does not own investments in associates and joint ventures that are significant, with the exception of the investment in IDS.

The assets and liabilities as of March 31, 2019 and December 31, 2018 of IDS are detailed below:

	<b>March 31, 2019</b>	<b>December 31, 2018</b>
Non-current assets .....	20,397	15,901
Current assets .....	5,546,622	4,529,672
<b>Total assets .....</b>	<b>5,567,019</b>	<b>4,545,573</b>
Current liabilities .....	568	162
<b>Total liabilities .....</b>	<b>568</b>	<b>162</b>
<b>Total shareholders' equity .....</b>	<b>5,566,451</b>	<b>4,545,411</b>
<b>Investment book value</b>	<b>2,385,881</b>	<b>1,948,163</b>

MARCOS BROWNE  
President



**YPF ENERGÍA ELÉCTRICA SOCIEDAD ANÓNIMA**  
**NOTES TO THE CONDENSED INTERIM CONSOLIDATED FINANCIAL STATEMENTS**  
**AS OF MARCH 31, 2019, AND COMPARATIVE INFORMATION (UNAUDITED)**  
(Amounts expressed in thousands of Argentine Pesos, except as otherwise indicated)



The following table shows information of investment in joint ventures as of March 31, 2019 and December 31, 2018.

Name and issuer	03.31.2019					12.31.2018	
	Class	Class		Book value	Cost	Book value	Cost
		Face value	Amount				
<b>Investments under common control:</b>							
Inversora Dock Sud S.A.	Common	1	335,270,372	2,385,881	538,065	1,948,163	538,065
<b>Other companies:</b>							
Miscellaneous <sup>(1)</sup>				234	234	329	329
				<b>2,386,115</b>	<b>538,199</b>	<b>1,948,492</b>	<b>538,494</b>

Name and issuer	Registered address	Main business	Information of the issuers				
			Last available financial statements				Holding in capital stock
			Date	Capital stock	Net profit / (loss)	Shareholders' equity	
<b>Investments under common control:</b>							
Inversora Dock Sud S.A.	San Martín 140, P.2°, Buenos Aires.	Realization of financial and investment operations.	03/31/2019	828,942	880,661	6,946,623	42.86%

(1) Includes Y-GEN Eléctrica III S.R.L., Y-GEN Eléctrica IV S.R.L., Y-Luz Inversora S.A.U. and Luz del Río S.A.

MARCOS BROWNE  
President

**YPF ENERGÍA ELÉCTRICA SOCIEDAD ANÓNIMA**  
**NOTES TO THE CONDENSED INTERIM CONSOLIDATED FINANCIAL STATEMENTS**  
**AS OF MARCH 31, 2019, AND COMPARATIVE INFORMATION (UNAUDITED)**

(Amounts expressed in thousands of Argentine Pesos, except as otherwise indicated)

## 12. OTHER RECEIVABLES

	March 31, 2019		December 31, 2018	
	Non-current	Current	Non-current	Current
Loans and advances to employees .....	-	6,594	-	6,309
Advances to suppliers to property, plant and equipment.....	1,967,939	-	1,231,559	-
Minimum presumed income tax .....	161,687	-	161,687	-
Related parties (Note 29) .....	452,881	139,344	452,881	5,374,731
Tax credits .....	-	853,335	-	736,536
Advances to suppliers .....	-	10,161	-	4,179
Trust .....	-	96,263	-	27,116
Recovery of insurance claims receivables.....	-	49,446	-	5,526
Prepaid expenses.....	-	15,662	-	71,490
Miscellaneous.....	-	459,161	-	11,473
	<b>2,582,507</b>	<b>1,629,966</b>	<b>1,846,127</b>	<b>6,237,360</b>
Provision for doubtful receivables .....	-	(3,056)	-	(3,056)
	<b>2,582,507</b>	<b>1,626,910</b>	<b>1,846,127</b>	<b>6,234,304</b>

## 13. TRADE RECEIVABLES

	March 31, 2019	December 31, 2018
	Current	Current
Trade receivables .....	82,534	71,305
Related Parties (See note 29) .....	3,417,809	3,652,929
	<b>3,500,343</b>	<b>3,724,234</b>
Provision for doubtful trade receivables.....	(48,772)	-
	<b>3,451,571</b>	<b>3,724,234</b>

The following is the evolution of the provision for doubtful trade receivables during the three-month period ended March 31, 2019:

	Provision for doubtful trade receivables
As of December 31, 2018 .....	-
Increases with impact on net income .....	48,772
As of March 31, 2019 .....	<b>48,772</b>

## 14. CASH AND CASH EQUIVALENTS

For the purpose of the consolidated statement of financial position and the consolidated statement of cash flow, cash and cash equivalents comprise the following items:

	March 31, 2019	December 31, 2018
Mutual funds .....	6,326	-
Fixed interest deposits .....	7,413,980	4,209,240
Cash and banks .....	212,529	492,096
	<b>7,632,835</b>	<b>4,701,336</b>

Bank balances accrue interest at variable rates based on the bank deposits daily rates. Short-term deposits are made for varying periods of between one day and three months, depending on the immediate cash needs of the Group and bear interest at the respective fixed rates for short-term deposits.

MARCOS BROWNE  
 President

**YPF ENERGÍA ELÉCTRICA SOCIEDAD ANÓNIMA**  
**NOTES TO THE CONDENSED INTERIM CONSOLIDATED FINANCIAL STATEMENTS**  
**AS OF MARCH 31, 2019, AND COMPARATIVE INFORMATION (UNAUDITED)**  
(Amounts expressed in thousands of Argentine Pesos, except as otherwise indicated)

### 15. INCOME TAX

The calculation of the income tax expense accrued for the three-month period ended March 31, 2019 and 2018 is as follows:

	For the three-month period ended March 31,	
	2019	2018
Deferred income tax .....	(197,080)	(115,228)
<b>Income Tax</b> .....	<b>(197,080)</b>	<b>(115,228)</b>
	For the three-month period ended March 31,	
	2019	2018
Income tax from continued operations .....	(197,080)	(113,147)
Income tax from discontinued operations (Note 22) .....	-	(2,081)
<b>Income Tax</b> .....	<b>(197,080)</b>	<b>(115,228)</b>

The reconciliation between the charge to income tax expense for the three-month period ended March 31, 2019 and 2018 and the one that would result from applying the prevailing tax rate on income before income tax arising from the consolidated statements of comprehensive income for those periods is as follows:

	For the three-month period ended March 31,	
	2019	2018
Income before income tax from continued operations .....	1,314,351	2,016,985
Income before income tax from discontinued operations .....	-	15,377
<b>Profit for the period before income tax</b> .....	<b>1,314,351</b>	<b>2,032,362</b>
Statutory tax rate .....	30%	30%
Income tax charge at statutory tax rate .....	(394,305)	(609,709)
Effects of the valuation of non-monetary assets in its functional currency .....	(699,858)	(84,912)
Exchange differences .....	918,372	79,294
Income on investments in associates .....	39,344	13,181
Remeasure of pre-existing equity interest .....	-	535,510
Effect by change of tax rate <sup>(1)</sup> .....	(61,379)	(19,120)
Other .....	746	(29,472)
<b>Income tax for the period</b> .....	<b>(197,080)</b>	<b>(115,228)</b>

(1) Effect of applying the changes in the enacted tax rate established by Law No. 27,430, as described in Note 25 to the annual consolidated financial statements, to the deferred assets and liabilities, according to its expected term of realization and settlement, respectively.

Breakdown of deferred income tax as of March 31, 2019 and December 31, 2018 is as follows:

	March 31, 2019	December 31, 2018
	<b>Deferred tax assets</b>	
Provisions for doubtful receivables .....	12,957	764
Tax Losses carryforward <sup>(1)</sup> .....	1,903,096	1,465,492
Miscellaneous .....	10,278	9,386
<b>Total deferred tax assets</b> .....	<b>1,926,331</b>	<b>1,475,642</b>
<b>Deferred tax liabilities</b>		
Receivables from deferred income .....	(43,412)	(43,412)
Property, plant and equipment .....	(4,685,400)	(3,790,713)
Subsidiaries hedging instruments .....	(10,726)	(17,987)
<b>Total deferred tax liabilities</b> .....	<b>(4,739,538)</b>	<b>(3,852,112)</b>
<b>Total assets and liabilities deferred tax</b> .....	<b>(2,813,207)</b>	<b>(2,376,470)</b>

(1) The main increase is due to the exchange difference caused by foreign currency other than the Argentine peso that generate a tax bases loss and, therefore, an increase of tax losses carryforward.

MARCOS BROWNE  
President

**YPF ENERGÍA ELÉCTRICA SOCIEDAD ANÓNIMA**  
**NOTES TO THE CONDENSED INTERIM CONSOLIDATED FINANCIAL STATEMENTS**  
**AS OF MARCH 31, 2019, AND COMPARATIVE INFORMATION (UNAUDITED)**



(Amounts expressed in thousands of Argentine Pesos, except as otherwise indicated)

Deferred tax assets and liabilities are disclosed net when: a) a legal right to compensate asset and liabilities exists and; b) when tax assets and liabilities are against the same tax authority.

As of March 31, 2019, and December 31, 2018, 36,029 and 54,153 have been classified as deferred tax assets, respectively, and 2,849,236 and 2,430,623 as deferred tax liabilities, respectively, arising from net deferred tax positions of each of the companies that are included in these consolidated condensed interim financial statements.

As of March 31, 2019, the Group estimated a tax loss carryforward of 1,903,096 at the tax rate. Deferred income tax assets are recognized for tax loss carryforwards to the extent their set off through future taxable profits is probable. Tax loss carryforwards in Argentina expire within 5 years.

In order to fully realize the deferred income tax asset, the Group will need to generate taxable income. Based upon the level of historical taxable income and projections for future over the years in which the deferred income tax is deductible, Management of the Company believes that as of March 31, 2019 it is probable that the Group will realize all of the deferred income tax assets.

As of March 31, 2019, Group's tax loss carryforwards at the expected recovery rate were as follows:

<u>Date of generation</u>	<u>Date of expiration</u>	<u>Amount</u>
2016	2021	7,183
2017	2022	226,721
2018	2023	1,231,588
2019	2024	437,604
		<b>1,903,096</b>

As of March 31, 2019, and December 31, 2018, the causes that generate charges to other comprehensive income, did not create temporary differences for income tax.

The evolution of deferred tax assets and liabilities as of March 31, 2019 and December 31, 2018 is as follows:

	<u>Total</u>
<b>Amount as of December 31, 2017</b>	<b>(347,288)</b>
Other comprehensive income	(5,047)
Business combination (Note 3.b to annual consolidated financial statements)	(952,166)
Conversion effect on business combination assets	(783,713)
Charge to net income of the year	(288,256)
<b>Amount as of December 31, 2018</b>	<b>(2,376,470)</b>
Other comprehensive income	7,261
Conversion effect on business combination assets	(246,918)
Charge to net income of the period	(197,080)
<b>Amount as of March 31, 2019</b>	<b>(2,813,207)</b>

MARCOS BROWNE  
 President

**YPF ENERGÍA ELÉCTRICA SOCIEDAD ANÓNIMA**  
**NOTES TO THE CONDENSED INTERIM CONSOLIDATED FINANCIAL STATEMENTS**  
**AS OF MARCH 31, 2019, AND COMPARATIVE INFORMATION (UNAUDITED)**  
(Amounts expressed in thousands of Argentine Pesos, except as otherwise indicated)

**YPF LUZ**

**16. LEASES LIABILITIES**

The following is a breakdown of the lease liabilities recorded by the Group as of March 31, 2019, with identification of the term of the lease and each rates:

Lease term	Monthly effective rate used	March 31, 2019
Two to three year .....	7.87%	126,459
Three to four year .....	7.75% - 8.35%	227,621
More than five years.....	9.88% - 9.90%	105,221
<b>Total</b>		<b>459,301</b>

The financial accretion accrued in the three-month period ended March 31, 2019, arising from lease contracts, amounts to 6,564, which are exposed in the line "Financial accretion" in the "Financial loss" included in "Net financial results" of the statement of comprehensive income (see Note 21).

As of March 31, 2019, the maturities of the liabilities related to lease agreements are:

	March 31, 2019
Up to one year .....	100,748
<b>Current leases liabilities</b>	<b>100,748</b>
One to five years .....	256,010
From the 6th year onwards .....	102,543
<b>Non current leases liabilities</b>	<b>358,553</b>
<b>Total</b>	<b>459,301</b>

**17. LOANS**

	Interest rate <sup>(1)</sup>	March 31, 2019		December 31, 2018	
		Noncurrent	Current	Noncurrent	Current
Financial loans .....	4.19% - 8.40%	20,943,971	6,809,814	18,096,828	6,463,984
Financial leases.....	8.35%	-	-	159,742	50,424
		<b>20,943,971</b>	<b>6,809,814</b>	<b>18,256,570</b>	<b>6,514,408</b>

(1) Annual interest rate as of March 31, 2019.

The description of the Group's principal loans is included in Note 13 to the annual consolidated financial statements.

The evolution of the Group's loans as of the three-month period ended on March 31, 2019 and for the year ended December 31, 2018 is as follows:

	Loans
<b>Amount as of December 31, 2017</b> .....	<b>4,080,979</b>
Proceeds from loans .....	9,877,729
Payments of loans.....	(2,355,833)
Payments of interest.....	(949,923)
Accrued interest <sup>(1)</sup> .....	1,114,414
Non-cash transactions <sup>(3)</sup> .....	(352,971)
Incorporation by business combinations <sup>(2)</sup> .....	4,176,661
Net exchange differences and translation .....	9,179,922
<b>Amount as of December 31, 2018</b> .....	<b>24,770,978</b>
Payments of loans.....	(509,812)
Payments of interest.....	(519,891)
Accrued interest <sup>(1)</sup> .....	535,182
Net exchange differences and translation .....	3,687,494
Reclassifications <sup>(4)</sup> .....	(210,166)
<b>Amount as of March 31, 2019</b> .....	<b>27,753,785</b>

(1) Includes capitalized financial costs.

(2) See Note 3.b) to the annual consolidated financial statements.

(3) The "Non-cash transactions" includes the loans capitalization with YPF and the offsetting effect of the loan with YPF related to disposal of the interest in the Ramos Consortium. The group classifies interest paid as cash flows from financing activities.

(4) Corresponds to reclassification of lease liabilities, according to IFRS 16.

MARCOS BROWNE  
President

**YPF ENERGÍA ELÉCTRICA SOCIEDAD ANÓNIMA**  
**NOTES TO THE CONDENSED INTERIM CONSOLIDATED FINANCIAL STATEMENTS**  
**AS OF MARCH 31, 2019, AND COMPARATIVE INFORMATION (UNAUDITED)**



(Amounts expressed in thousands of Argentine Pesos, except as otherwise indicated)

**18. ACCOUNTS PAYABLE**

	<b>March 31, 2019</b>	<b>December 31, 2018</b>
	<b>Current</b>	<b>Current</b>
Trade <sup>(1)</sup> .....	776,616	934,147
Related parties <sup>(1) (2)</sup> .....	5,811,622	3,631,382
	<b>6,588,238</b>	<b>4,565,529</b>

(1) Commercial accounts payable do not accrue interest and are normally cancelled within 90 days.

(2) For information on related parties, see Note 29.

**19. REVENUES**

<u>Type of good or services</u>	<b>For the three-month period ended March 31,</b>	
	<b>2019</b>	<b>2018</b>
Energía Base <sup>(1)</sup>	926,128	551,522
Revenues under PPAs	1,629,260	11,870
Steam sales	136,294	60,239
Other services income	-	20,758
	<b>2,691,682</b>	<b>644,389</b>

<u>By Customer</u>	<b>For the three-month period ended March 31,</b>	
	<b>2019</b>	<b>2018</b>
CAMMESA <sup>(2)</sup>	1,977,170	551,522
YPF <sup>(2)</sup>	621,962	70,926
Y-GEN <sup>(2) (3)</sup>	-	10,209
Y-GEN II <sup>(2) (3)</sup>	-	10,549
UT Loma Campana <sup>(2)</sup>	26,170	1,183
Profertil S.A. <sup>(2)</sup>	22,152	-
Coca-Cola FEMSA de Buenos Aires S.A.	13,866	-
Toyota Argentina S.A.	12,668	-
Other	17,694	-
	<b>2,691,682</b>	<b>644,389</b>

(1) Power generation from Res. SEE 01/2019 and earlier

(2) Related companies (See Note 29).

(3) Companies controlled since March 31, 2018.

**Target Market**

The Group's revenues are aimed at the domestic market as a whole.

MARCOS BROWNE  
President

**YPF ENERGÍA ELÉCTRICA SOCIEDAD ANÓNIMA**  
**NOTES TO THE CONDENSED INTERIM CONSOLIDATED FINANCIAL STATEMENTS**  
**AS OF MARCH 31, 2019, AND COMPARATIVE INFORMATION (UNAUDITED)**  
(Amounts expressed in thousands of Argentine Pesos, except as otherwise indicated)



**20. EXPENSES BY NATURE**

The Group presents the statement of comprehensive income by classifying expenses according to their function as part of the "Production Costs" and "Administrative and selling expenses" lines. The following additional information is disclosed as required, on the nature of the expenses and their relation to the function within the Group for the three-month period ended March 31, 2019 and 2018:

	For the three-month period ended March 31, 2019		
	Production costs	Administrative and selling expenses	Total
Depreciation of property, plant and equipment	503,964	-	503,964
Depreciation of right of use assets	25,756	5,497	31,253
Consumable materials and supplies	28,772	2,129	30,901
Banking expenses	-	101	101
Rentals	175	3,094	3,269
Fees and compensation for services	5,424	7,005	12,429
Other personnel expenses	7,309	13,137	20,446
Preservation, repair and maintenance	31,718	21	31,739
Insurance	39,507	87	39,594
Salaries and social security taxes	96,943	70,961	167,904
Operation services and other contracts	102,741	-	102,741
Transportation, products and charges	30,923	-	30,923
Fuel, gas, energy and miscellaneous	11,849	-	11,849
Provision for doubtful trade receivables	-	48,772	48,772
Taxes, rates and contributions	2,423	92,030	94,453
Publicity and advertising expenses	-	713	713
Miscellaneous	5,314	4,219	9,533
<b>Total 2019</b>	<b>892,818</b>	<b>247,766</b>	<b>1,140,584</b>

	For the three-month period ended March 31, 2018		
	Production costs <sup>(1)</sup>	Administrative and selling expenses <sup>(1)</sup>	Total
Depreciation of property, plant and equipment	65,996	-	65,996
Consumable materials and supplies	2,114	216	2,330
Banking expenses	-	198	198
Rentals	54	136	190
Fees and compensation for services	217	3,981	4,198
Other personnel expenses	31,501	2,415	33,916
Preservation, repair and maintenance	11,525	471	11,996
Insurance	7,324	-	7,324
Salaries and social security taxes	70,131	17,533	87,664
Operation services and other contracts	15,987	-	15,987
Transportation, products and charges	18,689	-	18,689
Fuel, gas, energy and miscellaneous	653	-	653
Taxes, rates and contributions	4,639	16,891	21,530
Publicity and advertising expenses	-	24	24
Miscellaneous	4,890	7,352	12,242
<b>Total 2018</b>	<b>233,720</b>	<b>49,217</b>	<b>282,937</b>

(1) Net of discontinued operations (Note 22).

MARCOS BROWNE  
President

**YPF ENERGÍA ELÉCTRICA SOCIEDAD ANÓNIMA**  
**NOTES TO THE CONDENSED INTERIM CONSOLIDATED FINANCIAL STATEMENTS**  
**AS OF MARCH 31, 2019, AND COMPARATIVE INFORMATION (UNAUDITED)**  
(Amounts expressed in thousands of Argentine Pesos, except as otherwise indicated)



**21. NET FINANCIAL RESULTS**

	For the three-month period ended March 31,	
	2019	2018
<b>Finance income</b>		
Interest income <sup>(1)</sup> .....	71,640	10,637
Exchange differences <sup>(2)</sup> .....	444,116	259,113
<b>Total finance income</b> .....	<b>515,756</b>	<b>269,750</b>
<b>Finance loss</b>		
Interest loss .....	(399,995)	(28,958)
Exchange differences <sup>(2)</sup> .....	(510,928)	(413,935)
Finance accretion .....	(6,564)	-
<b>Total finance loss</b> .....	<b>(917,487)</b>	<b>(442,893)</b>
<b>Total net financial results</b> .....	<b>(401,731)</b>	<b>(173,143)</b>

(1) Includes interest of financial asset at fair value through profit or loss for 17,571 and 3,396 as of March 31, 2019 and 2018 respectively.

(2) The breakdown as of March 31, 2019 and March 31, 2018 are: finance asset and liabilities at amortized cost 113,589 and (148,017), financial asset at fair value through profit or loss (716) and (11,537); and non financial asset and liabilities (179,685) and 4,372, respectively.

**22. DISCONTINUED OPERATIONS – RAMOS CONSORTIUM**

	For the three-month period ended March 31,	
	2019	2018
Revenues .....	-	41,502
Production costs .....	-	(22,048)
<b>Gross profit</b> .....	-	19,454
Administrative expenses and selling expenses .....	-	(4,077)
<b>Net profit for the period before income tax from discontinued operations</b> .....	-	15,377
Income tax for the period .....	-	(2,081)
<b>Net profit for the period from discontinued operations</b> .....	-	<b>13,296</b>

**23. SHAREHOLDERS' EQUITY**

As of March 31, 2019, the common stock of the Company amounted to 3,747,070,355 represented by ordinary shares with a par value of 1, with the right to one vote per share, which is subscribed, integrated, issued and registered.

As of March 31, 2019 the shareholders of YPF EE are as follows:

Shareholder	Number of Shares	Participation in the common stock	Class of Share
YPF	2,723,826,879	72.69218%	A
OPESSA	86,476,112	2.30783%	A
GE	936,767,364	24.99999%	B
<b>Total</b>	<b>3,747,070,355</b>	<b>100.00000%</b>	

On May 7, 2019, the Ordinary Shareholder's Meeting approved the financial statements of YPF EE for the fiscal year ended December 31, 2018 and decided regarding profit allocation, as follows: a) allocate the sum of 11,532 corresponding to the initial adjustment for the implementation of the IFRS to constitute a special reserve in accordance with the provisions of General Resolution No. 609 of the CNV. b) allocate the sum of 225,271 to constitute a legal reserve in accordance with the provisions of Article 70, first paragraph of the LGS, c) allocate the sum of 4,198,813 to constitute a Reserve for investments under the terms of Article 70, third paragraph of the LGS.

MARCOS BROWNE  
President



**YPF ENERGÍA ELÉCTRICA SOCIEDAD ANÓNIMA**  
**NOTES TO THE CONDENSED INTERIM CONSOLIDATED FINANCIAL STATEMENTS**  
**AS OF MARCH 31, 2019, AND COMPARATIVE INFORMATION (UNAUDITED)**  
(Amounts expressed in thousands of Argentine Pesos, except as otherwise indicated)



## 24. EARNINGS PER SHARE

The following table shows the net income and the number of shares that have been used for the calculation of the basic and diluted earnings per share:

	For the three-month period ended	
	March 31,	
	2019	2018
Net profit for the period attributable to holders of the parent company:		
Continuing operations	1,117,271	1,903,838
Discontinuing operations	-	13,296
	<b>1,117,271</b>	<b>1,917,134</b>
Weighted average per share	<b>3,747,070</b>	<b>2,884,297</b>
Basic and diluted earnings per share from continued and discontinued operations:		
- Basic and diluted	0.298	0.665
Basic and diluted earnings per share from continued operations		
- Basic and diluted	0.298	0.660

Basic and diluted earnings per share are calculated as shown in Note 20 to the annual consolidated financial statements.

There have been no transactions involving ordinary shares or potential ordinary shares between the reporting date and the date of issuance of these condensed interim consolidated financial statements that may produce a dilution effect.

## 25. RESTRICTION ON RETAINED EARNINGS

Pursuant to the Argentine Companies Act and the corporate bylaw, 5% of the net profit for the year must be allocated to the legal reserve until such reserve reaches 20% of the capital stock.

## 26. MAIN CONTRACTUAL COMMITMENTS AND GUARANTEES GRANTED

Contractual commitments are described in Note 23 to the annual consolidated financial statements.

## 27. CONTINGENT LIABILITIES

Within the framework of the Contract to Close the Gas Turbine Cycle of El Bracho, Province of Tucumán ("Cycle Closing Contract"), celebrated between General Electric Parts & Products GmbH, as equipment supplier ("GEPP"), General Electric Suc. Arg., as contractor of the work ("GESA" and, together with GEPP, "GE") and Y-GEN II, as acquirer and commissioner respectively, YGEN II was notified on March 20, 2019 by GE that on March 10, 2019 a fire started on the deck of the ship "Grande America" that belonged to maritime company Grimaldi Group, which led to its subsequent sinking, on March 12, 2019, 150 nautical miles off the coast of France. This vessel was transporting essential equipment to complete the cycle closure of El Bracho Gas Turbine, object of the Cycle Closing Contract whose invoice value amounted to an approximate sum of € 9.6 million. In accordance with the Cycle Closing Contract, the risk of equipment loss is under the responsibility of GE until they are received at the construction site. Likewise, GE contracted an insurance policy giving coverage to the possible damages and / or material losses that the equipment could have during the transport and whose beneficiary is YGEN II. As of the date of these financial statements, GE is analyzing different mitigation plans for the risks associated with this collapse and its impact on the terms and prices in the Cycle Closing Contract.

MARCOS BROWNE  
President

(Amounts expressed in thousands of Argentine Pesos, except as otherwise indicated)

## 28. MAIN REGULATIONS AND OTHERS

Main regulations and others are described in Note 24 to the annual consolidated financial statements. Updates for the three-month period ended March 31, 2019 are described below:

### 28.a) Regulatory framework for the electric industry

- **Resolution 1-SRRyME/2019:** On February 28, 2019, with the purpose of securing sustainability of the wholesale electricity market, the Secretariat of Renewable Resources and Electricity Market issued Resolution No. 1-SRRyME/2019, pursuant to which the remuneration criteria established in Resolution 19/2017 of the former Secretary of Electric Energy were adjusted to economically reasonable and efficient conditions, which may be assigned and/or transferred to the demanding parties in the electricity market.

Like Resolution No. 19/2017, Resolution No. 1 will be provisionally applied until gradual definition and implementation of the regulatory mechanisms to achieve the autonomous, competitive and sustainable operation of the electricity market that will allow for the free interaction of supply and demand, and a technical, economic and operating functioning towards the integration of the different generation technologies to ensure a reliable system at a minimum cost.

The remuneration to authorized thermal generators is composed of a payment for the monthly available power, a payment for generated power and another for operated power.

a. Remuneration for available power

Power availability remuneration is subdivided into a base price associated to Actual Power Availability (DRP, by its acronym in Spanish) and a price for guaranteed power in compliance with the Offered Guaranteed Power (DIGO, by its acronym in Spanish). Power remuneration will be adjusted depending on the actual usage factor of generation equipment.

The DRP remuneration will range from 3,050 to 5,200 U\$/MW-month, according to the technology made available for the system and the DIGO remuneration will be 7,000 U\$/MW-month for winter and summer periods and 5,500 U\$/MW for the rest of the year.

b. Remuneration for Generated Energy

The remuneration for conventional thermal generation will contemplate as a maximum, per type of fuel consumed by each generation unit, the non-fuel variable costs, which are 4 U\$/MW hour for equipment consuming Natural Gas, 7 U\$/MW hour for Fuel Oil or Gasoil, 10 U\$/MW hour for Biofuels and 12 U\$/MW hour for mineral coal.

c. Remuneration for Operated Energy

Additionally, generators will receive a monthly remuneration for Operated Energy, represented by the integration of hourly power capacities for the period, valued at 1.4 U\$/MWh for any type of fuel. The hourly volume of Operated Energy must correspond to the optimum dispatch in order to comply with the energy and reserves assigned.

A generation plant that has declared the option to purchase fuels for the generation of energy, which upon request does not have sufficient fuel for the delivery, will lose its delivery order until, if necessary, CAMMESA shall assign fuel to it for its operation, and the remuneration concepts mentioned above will be reduced by 50% of their value.

Remuneration is denominated in US Dollars and is payable at the reference exchange rate of the date prior to maturity date.

MARCOS BROWNE  
 President

**YPF ENERGÍA ELÉCTRICA SOCIEDAD ANÓNIMA**  
**NOTES TO THE CONDENSED INTERIM CONSOLIDATED FINANCIAL STATEMENTS**  
**AS OF MARCH 31, 2019, AND COMPARATIVE INFORMATION (UNAUDITED)**  
(Amounts expressed in thousands of Argentine Pesos, except as otherwise indicated)



**28.b) Other regulatory requirements**

• **Regulatory Frame CNV (N.T. 2013)**

a) General Resolution No. 622 of CNV

- i. In accordance with the requirements of Article 1, Chapter III, Title IV of the aforementioned resolution, the notes to the consolidated financial statements that set forth the information requested by the Resolution in the form of appendix are detailed below.

Appendix A – Property, plant and equipment .....	Note 9 Property, plant and equipment
Appendix B – Intangible assets.....	Note 8 Intangible assets
Appendix C – Investments in shares .....	Note 11 Investments in Associates and Joint Ventures
Appendix D – Other Investments .....	Note 7 Financial Instruments by category
Appendix E – Provisions .....	Note 13 Trade receivables
	Note 12 Other receivables
Appendix F – Cost of sales and services	Note 20 Expenses by nature
Appendix G – Assets and liabilities in currencies other than peso.....	Note 30 Information required by article 63 of Law No. 19,550 - Assets and liabilities in currencies other than peso

b) General Resolution No. 629 of CNV

As a result of General Resolution No. 629 of the CNV, we inform that the supporting documentation of the Company's operations that is not located at the registered office is in the deposits of the following companies:

- Adea S.A., located in Plant 3 – Route 36, Km 31.5 – Florencio Varela – Buenos Aires Province.
- File S.R.L. located in Panamericana and R. S. Peña – Blanco Encalada – Luján de Cuyo – Mendoza Province.

Likewise, it is recorded that the detail of the documentation given in the custody is available at the registered headquarters, as well as the documentation referred to in article 5 clause a.3), Section I of Chapter V of Title II of the Regulations of the CNV.

MARCOS BROWNE  
President

**YPF ENERGÍA ELÉCTRICA SOCIEDAD ANÓNIMA**  
**NOTES TO THE CONDENSED INTERIM CONSOLIDATED FINANCIAL STATEMENTS**  
**AS OF MARCH 31, 2019, AND COMPARATIVE INFORMATION (UNAUDITED)**  
(Amounts expressed in thousands of Argentine Pesos, except as otherwise indicated)



**29. BALANCES AND TRANSACTIONS WITH RELATED PARTIES**

The information detailed in the tables below shows the balances with associates and joint ventures as of March 31, 2019 and December 31, 2018 and transactions with those parties for the three-month period ended March 31, 2019 and 2018.

	As of March 31, 2019			
	Other receivables		Trade receivables	Accounts payable
	Non Current	Current	Current	Current
<b>Joint controlling shareholder:</b>				
YPF S.A.	-	-	939,125	645,771
GE EFS Power Investment B.V.	-	-	-	-
<b>Associates:</b>				
Y-GEN Eléctrica III S.R.L.	-	-	-	-
Y-GEN Eléctrica IV S.R.L.	-	-	-	-
Refinería del Norte S.A.	-	-	24,176	-
Metroenergía S.A.	-	-	4,588	-
A-Evangelista S.A.	-	-	-	231,257
Bajo del Toro II S.R.L.	-	-	-	-
U.T. Loma Campana	-	-	26,447	-
General Electric International Inc.	-	-	-	3,528
GE Global Parts and Products GmbH	-	-	-	2,318,753
GE Water & Process Technologies SC	-	-	-	7,809
GE Energy Parts Inc.	-	-	-	866
GE Packaged Power Inc.	-	-	-	33,098
GE International Inc. Sucursal Argentina	-	-	-	823,170
GE Wind Energy Equipment	-	-	-	1,742,676
GE Intelligent Platforms	-	-	-	367
GE Sensing & Inspection Technologies	-	-	-	592
GE Jenbacher GMBH & CO OG	-	-	-	3,082
YPF Tecnología S.A.	-	-	-	653
Profertil S.A.	-	-	17,441	-
<b>Argentine federal government-controlled entities:</b>				
CAMMESA	452,881	139,344	2,406,032	-
<b>Total</b>	<b>452,881</b>	<b>139,344</b>	<b>3,417,809</b>	<b>5,811,622</b>

MARCOS BROWNE  
President

**YPF ENERGÍA ELÉCTRICA SOCIEDAD ANÓNIMA**  
**NOTES TO THE CONDENSED INTERIM CONSOLIDATED FINANCIAL STATEMENTS**  
**AS OF MARCH 31, 2019, AND COMPARATIVE INFORMATION (UNAUDITED)**  
(Amounts expressed in thousands of Argentine Pesos, except as otherwise indicated)

	As of December 31, 2018			
	Other receivables		Trade receivables	Accounts payable
	Current	Non Current	Current	Current
<b>Joint controlling shareholder:</b>				
YPF S.A.	-	-	1,758,720	1,819,452
GE EFS Power Investment B.V.	5,250,000	-	-	-
<b>Associates:</b>				
Y-GEN Eléctrica III S.R.L.	-	-	-	-
Y-GEN Eléctrica IV S.R.L.	-	-	-	-
Refinería del Norte S.A.	-	-	25,558	-
Metroenergía S.A.	-	-	2,892	-
A-Evangelista S.A.	-	-	-	342,895
Bajo del Toro II S.R.L.	-	-	-	-
U.T. Loma Campana	-	-	38,290	-
General Electric International Inc.	-	-	-	3,067
GE Global Parts and Products GmbH	-	-	-	822,572
GE Water & Process Technologies SC	-	-	-	6,502
GE Energy Parts Inc.	-	-	-	753
GE Packaged Power Inc.	-	-	-	18,750
GE International Inc. Sucursal Argentina	-	-	-	615,538
GE Intelligent Platforms	-	-	-	367
GE Senging & Inspection Technologies	-	-	-	397
GE Jenbacher GMBH & CO OG	-	-	-	683
YPF Tecnología S.A.	-	-	-	406
Profertil S.A.	-	-	11,138	-
<b>Argentine federal government-controlled entities:</b>				
CAMMESA	124,731	452,881	1,816,331	-
<b>Total</b>	<b>5,374,731</b>	<b>452,881</b>	<b>3,652,929</b>	<b>3,631,382</b>

(1) Companies consolidated since March 31, 2018. See note 3.b) to the annual consolidated financial statements.

	For the three-month period ended March 31					
	2019			2018		
	Revenues	Purchases of goods and services	Interest gain (loss) net	Revenues	Purchases and services	Interest gain (loss) net
<b>Joint controlling shareholder:</b>						
YPF S.A.	621,962	28,742	-	70,926	42,702	(320)
GE EFS Power Investment B.V.	-	-	-	-	-	-
<b>Associates:</b>						
Y-GEN Eléctrica III S.R.L.	-	-	-	-	-	-
Y-GEN Eléctrica IV S.R.L.	-	-	-	-	-	-
Refinería del Norte S.A.	-	-	-	-	-	-
Metroenergía S.A.	-	-	-	-	-	-
A-Evangelista S.A.	-	192,453	-	-	67,441	-
Bajo del Toro II S.R.L.	-	-	-	-	-	(14,031)
U.T. Loma Campana	26,170	-	-	1,183	-	-
General Electric International Inc.	-	738,082	-	-	-	-
GE Global Parts and Products GmbH	-	1,209,301	-	-	-	-
GE Water & Process Technologies SC	-	4,387	-	-	-	-
GE Wind Energy Equipment	-	1,389,044	-	-	-	-
GE Energy Parts Inc.	-	-	-	-	-	-
GE Packaged Power Inc.	-	50,602	-	-	-	-
GE International Inc. Sucursal Argentina	-	90,578	-	-	-	-
GE Intelligent Platforms	-	-	-	-	-	-
GE Senging & Inspection Technologies	-	123	-	-	-	-
GE Jenbacher GMBH & CO OG	-	2,248	-	-	-	-
YPF Tecnología S.A.	-	454	-	-	-	-
Profertil S.A.	22,152	-	-	-	-	-
<b>Argentine federal government-controlled entities:</b>						
CAMMESA	1,977,170	12,319	14,613	551,522	14,982	4,970
<b>Subsidiaries:</b>						
Y-GEN Eléctrica S.A.U. <sup>(1)</sup>	-	-	-	10,209	-	-
Y-GEN II Eléctrica S.A.U. <sup>(1)</sup>	-	-	-	10,549	-	-
<b>Total</b>	<b>2,647,454</b>	<b>3,718,333</b>	<b>14,613</b>	<b>644,389</b>	<b>125,125</b>	<b>(9,381)</b>

(1) Companies consolidated since March 31, 2018. See note 3.b) to the annual consolidated financial statements.

MARCOS BROWNE  
President

**YPF ENERGÍA ELÉCTRICA SOCIEDAD ANÓNIMA**  
**NOTES TO THE CONDENSED INTERIM CONSOLIDATED FINANCIAL STATEMENTS**  
**AS OF MARCH 31, 2019, AND COMPARATIVE INFORMATION (UNAUDITED)**  
(Amounts expressed in thousands of Argentine Pesos, except as otherwise indicated)



**Remuneration of the Administration**

During the three-month period ended March 31, 2019, the Directors' fees and compensation to key executives amounted to 25,399, respectively, being the same short-term benefits and constituting the only benefits granted to directors and key executives.

**30. ASSETS AND LIABILITIES IN CURRENCIES OTHER THAN PESO**

Account	03.31.2019			12.31.2018			
	Class and amount of currencies other than peso	Exchange rate <sup>(1)</sup>	Booked amount in pesos	Class and amount of currencies other than peso	Booked amount in pesos		
<b>NON-CURRENT ASSETS</b>							
Investment in financial assets	US\$	963	43.15	41,571	US\$	1,864	69,901
<b>Total of Non-Current Assets</b>				<b>41,571</b>			<b>69,901</b>
<b>CURRENT ASSETS</b>							
Other receivables	US\$	20	43.15	878	US\$	140,751	5,278,163
Trade receivables	US\$	59,223	43.15	2,555,452	US\$	95,756	3,590,857
Other financial assets	US\$	40,567	43.15	1,750,466	US\$	39,707	1,489,031
Cash and cash equivalents	US\$	175,280	43.15	7,563,341	US\$	107,679	4,037,970
<b>Total of Current Assets</b>				<b>11,870,137</b>			<b>14,396,021</b>
<b>Total of Assets</b>				<b>11,911,708</b>			<b>14,465,922</b>
<b>NON-CURRENT LIABILITIES</b>							
Loans	US\$	485,087	43.35	21,028,516 <sup>(2)</sup>	US\$	487,868	18,392,637 <sup>(2)</sup>
Leases liabilities	US\$	8,271	43.35	358,553	US\$	-	-
<b>Total of Non-Current Liabilities</b>				<b>21,387,069</b>			<b>18,392,637</b>
<b>CURRENT LIABILITIES</b>							
Accounts payable	US\$	85,933	43.35	3,725,183	US\$	51,076	1,925,556
	EUR	37,687	48.71	1,835,728	EUR	5,986	258,375 <sup>(3)</sup>
Loans	US\$	158,581	43.35	6,874,469 <sup>(3)</sup>	US\$	173,694	6,548,279
Other Liabilities	US\$	2,544	43.35	110,294	US\$	2,631	99,189
Leases liabilities	US\$	2,324	43.35	100,748	US\$	-	-
<b>Total of Current Liabilities</b>				<b>12,646,422</b>			<b>8,831,399</b>
<b>Total of Liabilities</b>				<b>34,033,491</b>			<b>27,224,036</b>

US\$: US Dollar.  
EUR: Euro.

- (1) Exchange rate in force at March 31, 2019 according to Banco Nación Argentina.  
(2) Corresponds to the nominal amount owed, which is disclosed under loans for 20,943,971 and 18,256,570 as of March 31, 2019 and December 31, 2018, respectively, net of commissions and costs demanded by the transaction.  
(3) Corresponds to the nominal amount owed, which is disclosed under loans for 6,809,814 and 6,514,408 as of March 31, 2019 and December 31, 2018, respectively, net of commissions and costs demanded by the transaction.

**31. SUBSEQUENT EVENTS**

On April 17, 2019, the Board of Directors of National Securities Commission (CNV) approved the YPF EE registration into the Public Offering regime for securities, and the launch of a Global Program for the Issuance of Simple Negotiable Obligations (non-convertible in shares) up to 1,500,000,000 dollars (or its equivalent in other currencies). With this resolution, the Company should comply with the regulations established by the CNV's Regulatory Framework as its new regulatory body and it is authorized to seek financing in local or international capital markets.

On April 30, 2019, the Board of Directors approved, within the framework of the abovementioned Global Program in circulation at any time, the issuance and placement by public offering of negotiable obligations for an amount of up to US \$ 100,000,000 (or its equivalent in other currencies), in one or more classes and / or series, in the terms that are determined in the respective price supplements.

MARCOS BROWNE  
President

**YPF ENERGÍA ELÉCTRICA SOCIEDAD ANÓNIMA****NOTES TO THE CONDENSED INTERIM CONSOLIDATED FINANCIAL STATEMENTS  
AS OF MARCH 31, 2019, AND COMPARATIVE INFORMATION (UNAUDITED)**

(Amounts expressed in thousands of Argentine Pesos, except as otherwise indicated)



On May 7, 2019, the Company issued Class I Negotiable Obligations (the "NO"), under the mentioned Global Programme. The placement reached 75,000,000 million dollars, at a 10.24% rate with a maturity date on 2021. The obtained financing will be allocated to the investments the Group is currently developing.

As of the date of issuance of these condensed interim consolidated financial statements, there have been no other significant subsequent events, whose effect on the Group's financial position and the results of operations for the three months periods ended March 31, 2019 and 2018 or their disclosure in these condensed interim consolidated financial statements, if applicable, have not been considered in accordance with IFRS.

MARCOS BROWNE  
President

**YPF ENERGÍA ELÉCTRICA S.A.**

Avenida Córdoba 111  
(C1054AAA), City of Buenos Aires  
Argentina

**TRUSTEE**

The Bank of New York Mellon  
240 Greenwich Street, Floor 7 East  
New York, NY 10286  
United States of America

**LUXEMBOURG LISTING AGENT**

The Bank of New York Mellon SA/NV, Luxembourg Branch  
Vertigo Building – Polaris,  
2-4 rue Eugene Ruppert  
L – 2453, Luxembourg

**INDEPENDENT AUDITORS**

Deloitte & Co. S.A.  
Florida 234 – Floor 5°  
(C1005AAF) City of Buenos Aires  
Argentina

**LEGAL ADVISORS TO THE ISSUER**

*In respect of U.S. Law*  
Simpson Thacher & Bartlett LLP  
425 Lexington Avenue  
New York, NY 10017  
United States of America

*In respect of Argentine Law*  
Estudio O'Farrell  
Av. de Mayo 645/651  
(C108AAB) City of Buenos Aires  
Argentina

**LEGAL ADVISORS TO THE INITIAL PURCHASERS**

*In respect of U.S. Law*  
Shearman & Sterling LLP  
599 Lexington Avenue  
New York, NY 10022  
United States of America

*In respect of Argentine Law*  
Tanoira Cassagne Abogados  
Juana Manso 205  
(C1107CBE) City of Buenos Aires  
Argentina





**US\$400,000,000**

**YPF ENERGÍA ELÉCTRICA S.A.  
10.000% Senior Notes due 2026**

---

**Offering Memorandum**

---

*Joint Lead Managers*

**Citigroup**

**HSBC**

**Itaú BBA**

*Local Placement Agent*

**Itaú BBA**

**July 18, 2019**